

CEFC301 Thru CEFC305

Reverse Voltage: 50 - 600 Volts
Forward Current: 3.0 Amp

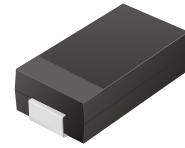

Features

- Ideal for surface mount applications
- Easy pick and place
- Plastic package has Underwriters Lab. flammability classification 94V-0
- Super fast recovery time for high efficient
- Built-in strain relief
- Low forward voltage drop

Mechanical Data

- Case: JEDEC DO-214AB molded plastic
- Terminals: solderable per MIL-STD-750, method 2026
- Polarity: Color band denotes cathode end
- Mounting position: Any
- Approx. Weight: 0.21 gram

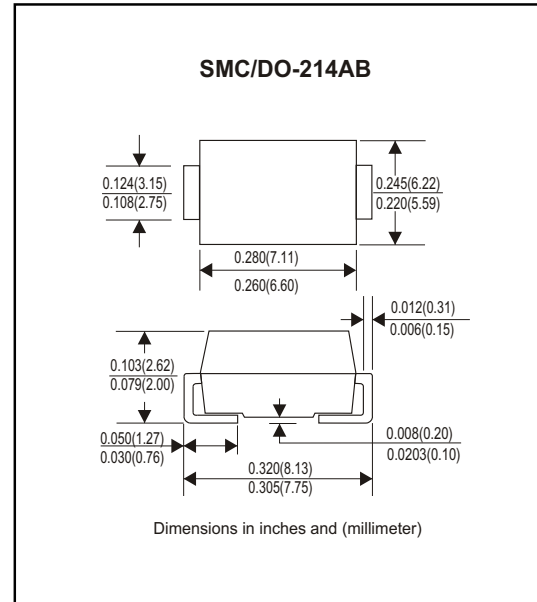

Maximum Ratings and Electrical Characteristics

Parameter	Symbol	CEFC 301	CEFC 302	CEFC 303	CEFC 304	CEFC 305	Unit
Max. Repetitive Peak Reverse Voltage	V _{RRM}	50	100	200	400	600	V
Max. DC Blocking Voltage	V _{DC}	50	100	200	400	600	V
Max. RMS Voltage	V _{RMS}	35	70	140	280	420	V
Peak Surge Forward Current 8.3ms single halfsine-wave superimposed on rate load (JEDEC method)	I _{FSM}	75					A
Max. Average Forward Current	I _o	3.0					A
Max. Instantaneous Forward Current at 3.0 A	V _F	0.875			1.1	1.25	V
Reverse recovery time	T _{rr}	25			35	50	nS
Max. DC Reverse Current at Rated DC Blocking Voltage Ta=25°C Ta=100°C	I _R	5.0 250					uA
Max. Thermal Resistance (Note 1)	R _{θJL}	13					°C/W
Operating Junction Temperature	T _j	-55 to +150					°C
Storage Temperature	T _{STG}	-55 to +150					°C

Note 1: Thermal resistance from junction to lead P.C.B. Mounted on 8.0x8.0 mm copperpad areas.

Rating and Characteristic Curves (CEFC301 Thru CEFC305)

Fig. 1 - Reverse Characteristics

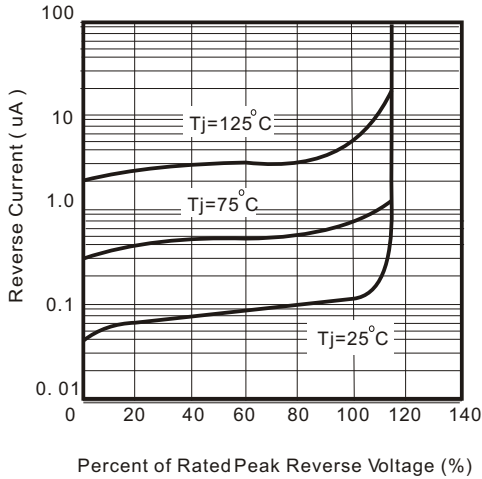

Fig.2 - Forward Characteristics

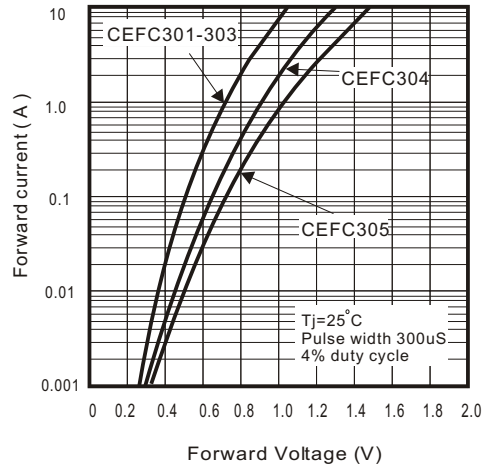

Fig. 3 - Junction Capacitance

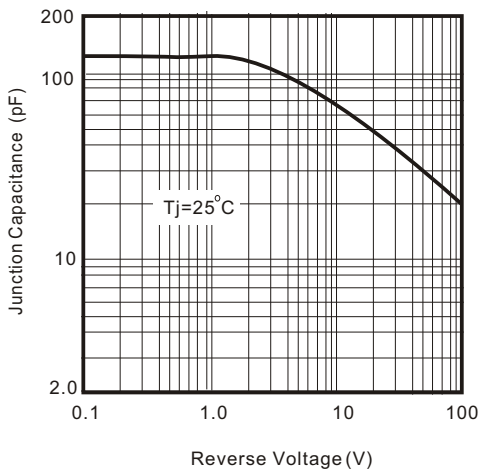

Fig. 4 - Non Repetitive Forward Surge Current

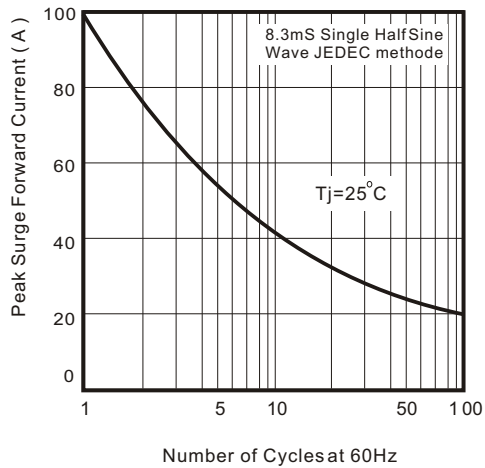
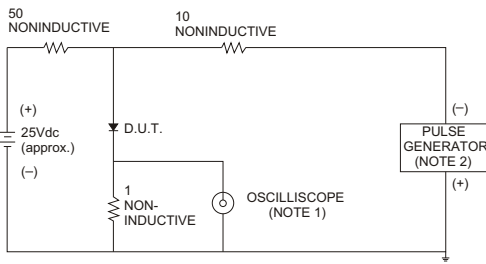

Fig. 5 - Test Circuit Diagram and Reverse Recovery Time Characteristics



NOTES: 1. Rise Time= 7ns max., Input Impedance= 1 megohm, 22pF.
2. Rise Time= 10ns max., Source Impedance= 50 ohms.

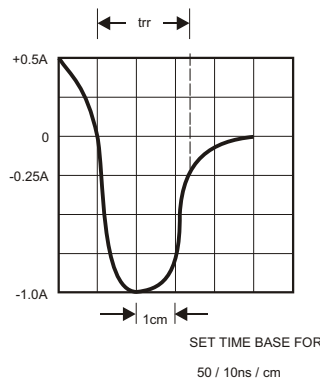

Fig. 6 - Current Derating Curve

