

CEG6946

PRELIMINARY

Dual N-Channel Enhancement Mode Field Effect Transistor

FEATURES

- 20V , 2.8A , $R_{DS(ON)}=80.0m\Omega$ @ $V_{GS}=4.5V$.
 $R_{DS(ON)}=110.0m\Omega$ @ $V_{GS}=2.5V$.
- Super high dense cell design for extremely low $R_{DS(ON)}$.
- High power and current handling capability.
- TSSOP-8 for Surface Mount Package.

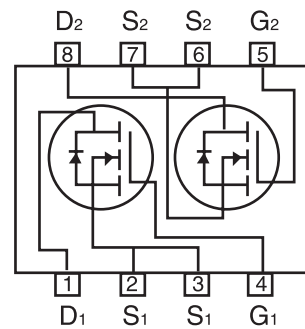
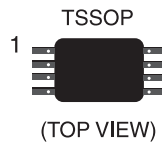

9

ABSOLUTE MAXIMUM RATINGS ($T_A=25^\circ C$ unless otherwise noted)

Parameter	Symbol	Limit	Unit
Drain-Source Voltage	V _{DS}	20	V
Gate-Source Voltage	V _{GS}	±8	V
Drain Current-Continuous ^a @ $T_J=125^\circ C$ -Pulsed ^b	I _D	2.8	A
	I _{DM}	20	A
Drain-Source Diode Forward Current ^a	I _S	1.0	A
Maximum Power Dissipation ^a	P _D	1.0	W
Operating Junction and Storage Temperature Range	T _J , T _{STG}	-55 to 150	°C

THERMAL CHARACTERISTICS

Thermal Resistance, Junction-to-Ambient ^a	R _{θJA}	125	°C/W
--	------------------	-----	------

CEG6946

ELECTRICAL CHARACTERISTICS (TA=25°C unless otherwise noted)

Parameter	Symbol	Condition	Min	Typ ^c	Max	Unit
OFF CHARACTERISTICS						
Drain-Source Breakdown Voltage	BV _{DSS}	V _{GS} = 0V, I _D =250μA	20			V
Zero Gate Voltage Drain Current	I _{DSS}	V _{DS} =20V, V _{GS} =0V			1	μA
Gate-Body Leakage	I _{GSS}	V _{GS} =±8V, V _{DS} =0V			±100	nA
ON CHARACTERISTICS^b						
Gate Threshold Voltage	V _{GS(th)}	V _{DS} =V _{GS} , I _D =250μA	0.5		1.5	V
Drain-Source On-State Resistance	R _{DS(ON)}	V _{GS} =4.5V, I _D =2.8A			80	mΩ
		V _{GS} =2.5V, I _D =2.1A			110	mΩ
On-State Drain Current	I _{D(ON)}	V _{DS} =5V, V _{GS} =4.5V	±10			A
Forward Transconductance	g _{FS}	V _{DS} =15V, I _D =2.8A	3			S
DYNAMIC CHARACTERISTICS^c						
Input Capacitance	C _{ISS}	V _{DS} = 10V, V _{GS} = 0V f = 1.0MHz		460	600	pF
Output Capacitance	C _{OSS}			310	400	pF
Reverse Transfer Capacitance	C _{RSS}			190	250	pF
SWITCHING CHARACTERISTICS^c						
Turn-On Delay Time	t _{D(ON)}	V _{DD} = 10V, I _D = 1A, V _{GEN} = 4.5V, R _{GEN} = 6Ω R _L = 10Ω		35	60	ns
Rise Time	t _r			60	100	ns
Turn-Off Delay Time	t _{D(OFF)}			50	100	ns
Fall time	t _f			55	100	ns
Total Gate Charge	Q _g	V _{DS} = 10V, I _D = 2.8A, V _{GS} = 4.5V		16	40	nC
Gate-Source Charge	Q _{gs}			3		nC
Gate-Drain Charge	Q _{gd}			6		nC

CEG6946

ELECTRICAL CHARACTERISTICS ($T_A=25^\circ\text{C}$ unless otherwise noted)

Parameter	Symbol	Condition	Min	Typ	Max	Unit
DRAIN-SOURCE DIODE CHARACTERISTICS ^a						
Diode Forward Voltage	V_{SD}	$V_{GS} = 0V, I_S = 1A$			1.2	V

Notes

- a. Pulse Test: Pulse Width $\leq 300 \mu s$, Duty Cycle $\leq 2\%$.
- b. Guaranteed by design, not subject to production testing.

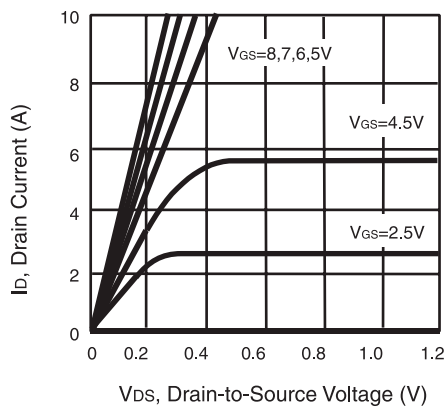

Figure 1. Output Characteristics

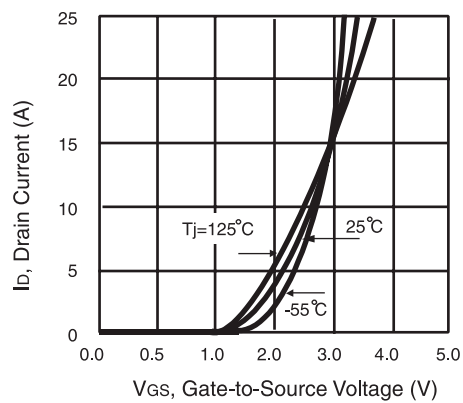

Figure 2. Transfer Characteristics

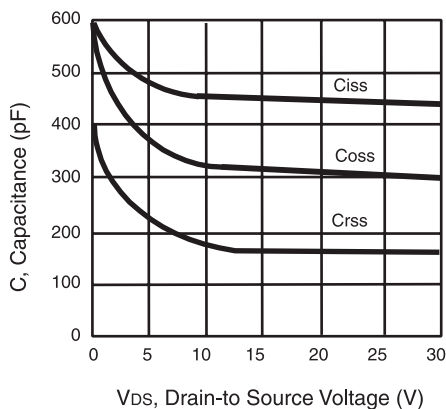

Figure 3. Capacitance

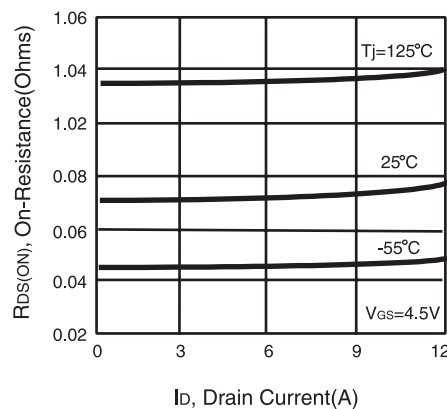

Figure 4. On-Resistance Variation with Drain Current and Temperature

CEG6946

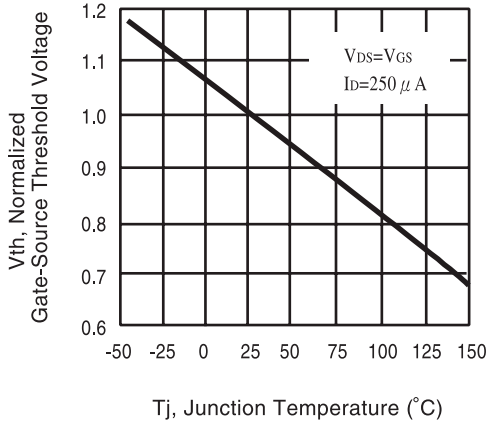

Figure 5. Gate Threshold Variation with Temperature

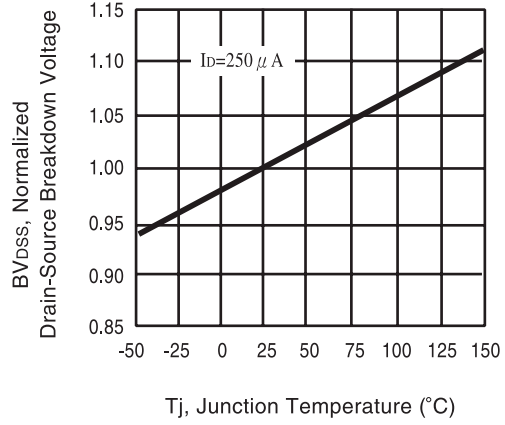

Figure 6. Breakdown Voltage Variation with Temperature

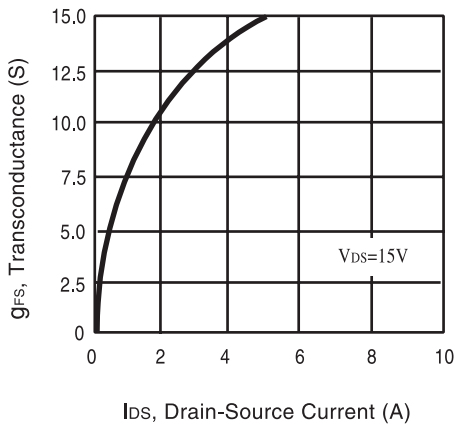

Figure 7. Transconductance Variation with Drain Current

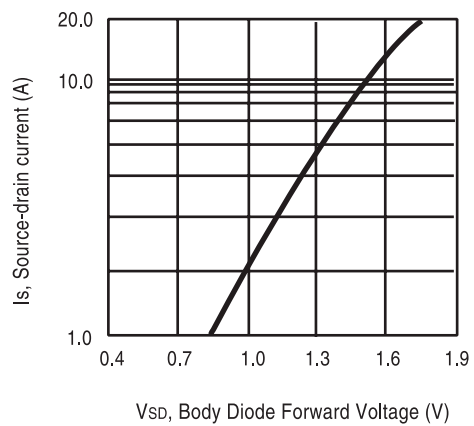

Figure 8. Body Diode Forward Voltage Variation with Source Current

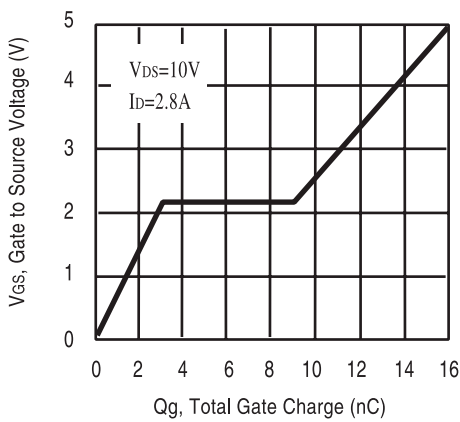

Figure 9. Gate Charge

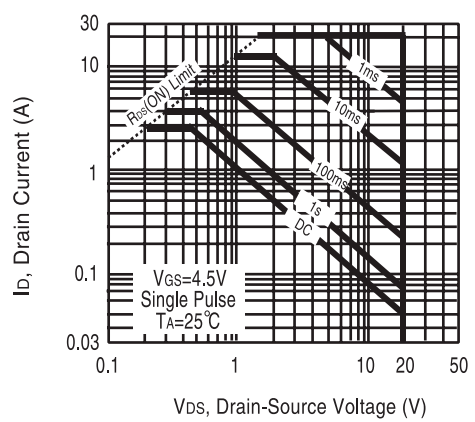

Figure 10. Maximum Safe Operating Area

CEG6946

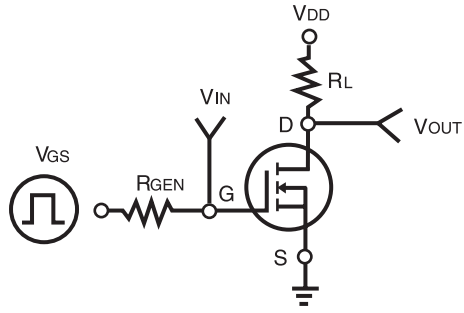

Figure 11. Switching Test Circuit

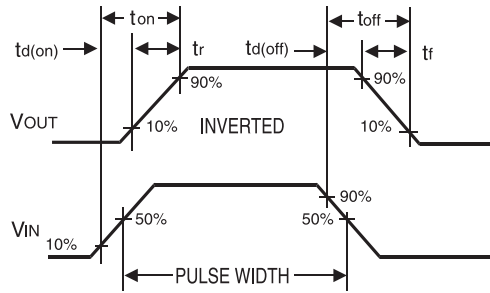

Figure 12. Switching Waveforms

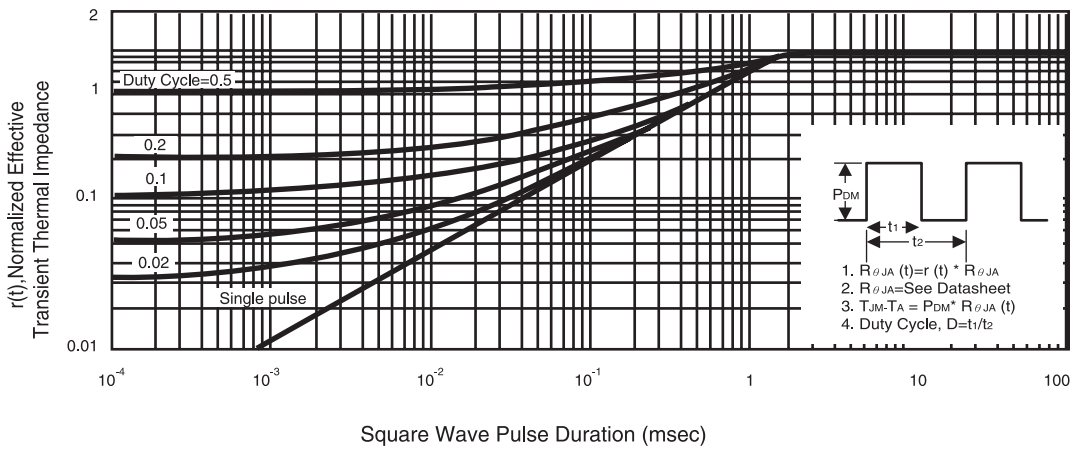

Figure 13. Normalized Thermal Transient Impedance Curve