

Dual Enhancement Mode Field Effect Transistor (N and P Channel)

FEATURES

- 20V, 6.5A, $R_{DS(ON)} = 30m\Omega$ @ $V_{GS} = 4.5V$.
 $R_{DS(ON)} = 43m\Omega$ @ $V_{GS} = 2.5V$.
- -20V, -4.8A, $R_{DS(ON)} = 55m\Omega$ @ $V_{GS} = -4.5V$.
 $R_{DS(ON)} = 90m\Omega$ @ $V_{GS} = -2.5V$.
- Super high dense cell design for extremely low $R_{DS(ON)}$.
- High power and current handling capability.
- Lead free product is acquired.
- Surface mount Package.

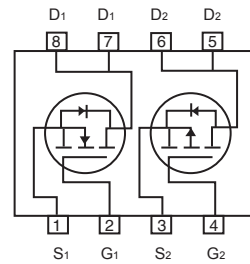
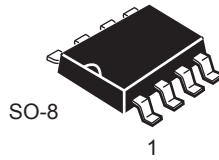

ABSOLUTE MAXIMUM RATINGS $T_A = 25^\circ C$ unless otherwise noted

Parameter	Symbol	N-Channel	P-Channel	Units
Drain-Source Voltage	V_{DS}	20	-20	V
Gate-Source Voltage	V_{GS}	± 12	± 12	V
Drain Current-Continuous	I_D	6.5	-4.8	A
Drain Current-Pulsed ^a	I_{DM}	20	-20	A
Maximum Power Dissipation	P_D	2.0		W
Operating and Store Temperature Range	T_J, T_{stg}	-55 to 150		$^\circ C$

Thermal Characteristics

Parameter	Symbol	Limit	Units
Thermal Resistance, Junction-to-Ambient ^b	$R_{\theta JA}$	62.5	$^\circ C/W$



CEM2939

N-Channel Electrical Characteristics $T_A = 25^\circ\text{C}$ unless otherwise noted

Parameter	Symbol	Test Condition	Min	Typ	Max	Units	
Off Characteristics							
Drain-Source Breakdown Voltage	BV_{DSS}	$V_{GS} = 0V, I_D = 250\mu A$	20			V	
Zero Gate Voltage Drain Current	I_{DSS}	$V_{DS} = 16V, V_{GS} = 0V$			1	μA	
Gate Body Leakage Current, Forward	I_{GSSF}	$V_{GS} = 12V, V_{DS} = 0V$			100	nA	
Gate Body Leakage Current, Reverse	I_{GSSR}	$V_{GS} = -12V, V_{DS} = 0V$			-100	nA	
On Characteristics^c							
Gate Threshold Voltage	$V_{GS(th)}$	$V_{GS} = V_{DS}, I_D = 250\mu A$	0.55		1.5	V	
Static Drain-Source On-Resistance	$R_{DS(on)}$	$V_{GS} = 4.5V, I_D = 6.5A$		25	30	m Ω	
		$V_{GS} = 2.5V, I_D = 5.4A$		35	43	m Ω	
Dynamic Characteristics^d							
Forward Transconductance	g_{FS}	$V_{DS} = 5V, I_D = 6.5A$		17		S	
Input Capacitance	C_{iss}	$V_{DS} = 8V, V_{GS} = 0V, f = 1.0\text{ MHz}$		910		pF	
Output Capacitance	C_{oss}				230		pF
Reverse Transfer Capacitance	C_{rss}				163		pF
Switching Characteristics^d							
Turn-On Delay Time	$t_{d(on)}$	$V_{DD} = 15V, I_D = 1A, V_{GS} = 4.5V, R_{GEN} = 6\Omega$		14	30	ns	
Turn-On Rise Time	t_r			10	20	ns	
Turn-Off Delay Time	$t_{d(off)}$			34	70	ns	
Turn-Off Fall Time	t_f			11	20	ns	
Total Gate Charge	Q_g	$V_{DS} = 10V, I_D = 6.5A, V_{GS} = 4.5V$		10	13	nC	
Gate-Source Charge	Q_{gs}			1.4		nC	
Gate-Drain Charge	Q_{gd}			3.2		nC	
Drain-Source Diode Characteristics and Maximum Ratings							
Drain-Source Diode Forward Current ^b	I_S				6.5	A	
Drain-Source Diode Forward Voltage ^c	V_{SD}	$V_{GS} = 0V, I_S = 1.3A$			1.2	V	
Notes : □ a.Repetitive Rating : Pulse width limited by maximum junction temperature.□ b.Surface Mounted on FR4 Board, $t \leq 10\text{ sec.}$ □ c.Pulse Test : Pulse Width $\leq 300\mu s$, Duty Cycle $\leq 2\%$.□ d.Guaranteed by design, not subject to production testing.□ □							



CEM2939

P-Channel Electrical Characteristics $T_A = 25^\circ\text{C}$ unless otherwise noted

Parameter	Symbol	Test Condition	Min	Typ	Max	Units
Off Characteristics						
Drain-Source Breakdown Voltage	BV_{DSS}	$V_{GS} = 0V, I_D = -250\mu A$	-20			V
Zero Gate Voltage Drain Current	I_{DSS}	$V_{DS} = -16V, V_{GS} = 0V$			-1	μA
Gate Body Leakage Current, Forward	I_{GSSF}	$V_{GS} = 12V, V_{DS} = 0V$			100	nA
Gate Body Leakage Current, Reverse	I_{GSSR}	$V_{GS} = -12V, V_{DS} = 0V$			-100	nA
On Characteristics ^c						
Gate Threshold Voltage	$V_{GS(th)}$	$V_{GS} = V_{DS}, I_D = -250\mu A$	-0.55		-1.5	V
Static Drain-Source On-Resistance	$R_{DS(on)}$	$V_{GS} = -4.5V, I_D = -3.2A$		43	55	$m\Omega$
		$V_{GS} = -2.5V, I_D = -1.0A$		64	90	$m\Omega$
Dynamic Characteristics ^d						
Forward Transconductance	g_{FS}	$V_{DS} = -5V, I_D = -5.5A$		10		S
Input Capacitance	C_{iss}	$V_{DS} = -10V, V_{GS} = 0V, f = 1.0\text{ MHz}$		1155		pF
Output Capacitance	C_{oss}			205		pF
Reverse Transfer Capacitance	C_{rss}			120		pF
Switching Characteristics ^d						
Turn-On Delay Time	$t_{d(on)}$	$V_{DD} = -10V, I_D = -4A, V_{GS} = -4.5V, R_{GEN} = 3\Omega$		13.4	26.8	ns
Turn-On Rise Time	t_r			8.4	16.8	ns
Turn-Off Delay Time	$t_{d(off)}$			73.4	146.8	ns
Turn-Off Fall Time	t_f			34.4	68.8	ns
Total Gate Charge	Q_g	$V_{DS} = -10V, I_D = -4A, V_{GS} = -4.5V$		9.8	13	nC
Gate-Source Charge	Q_{gs}			1.2		nC
Gate-Drain Charge	Q_{gd}			2.7		nC
Drain-Source Diode Characteristics and Maximum Ratings						
Drain-Source Diode Forward Current ^b	I_S				-4.8	A
Drain-Source Diode Forward Voltage ^c	V_{SD}	$V_{GS} = 0V, I_S = -2.0A$			-1.2	V
Notes : <input type="checkbox"/> a.Repetitive Rating : Pulse width limited by maximum junction temperature. <input type="checkbox"/> b.Surface Mounted on FR4 Board, $t \leq 10\text{ sec.}$ <input type="checkbox"/> c.Pulse Test : Pulse Width $\leq 300\mu s$, Duty Cycle $\leq 2\%$. <input type="checkbox"/> d.Guaranteed by design, not subject to production testing. <input type="checkbox"/> <input type="checkbox"/>						



N-CHANNEL

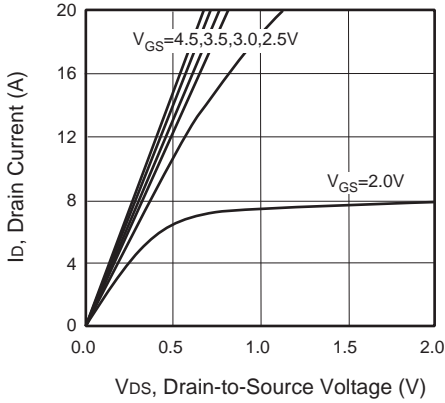

Figure 1. Output Characteristics

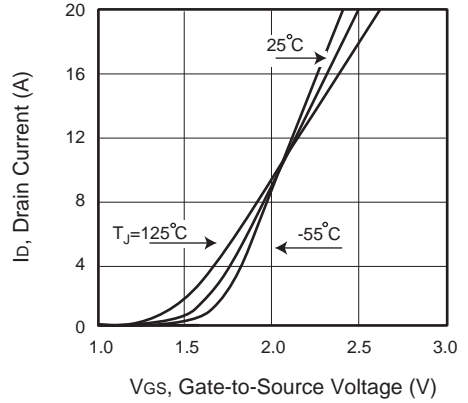

Figure 2. Transfer Characteristics

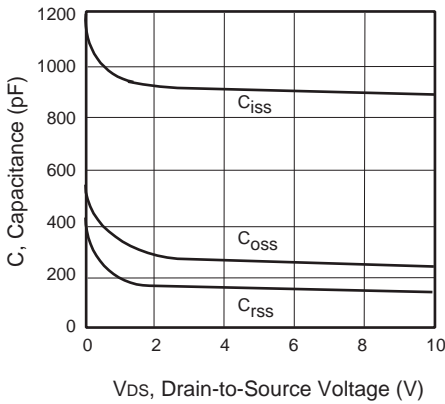

Figure 3. Capacitance

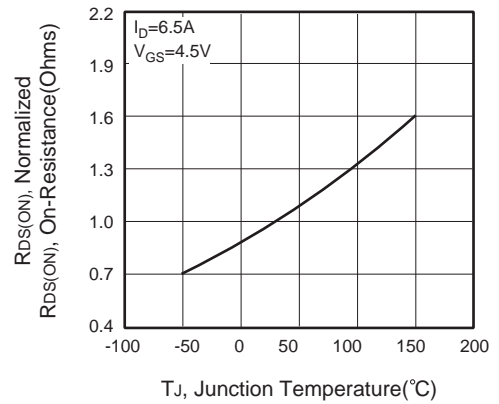

Figure 4. On-Resistance Variation with Temperature

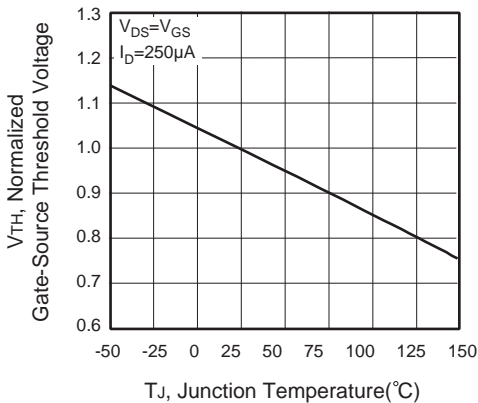

Figure 5. Gate Threshold Variation with Temperature

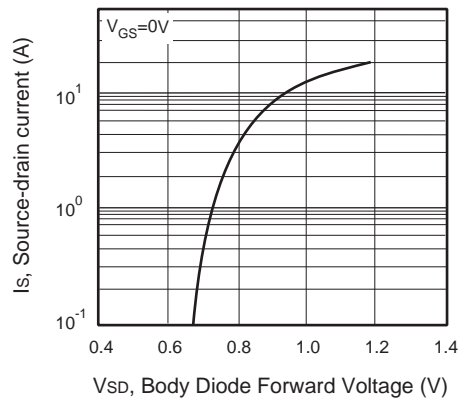

Figure 6. Body Diode Forward Voltage Variation with Source Current



P-CHANNEL

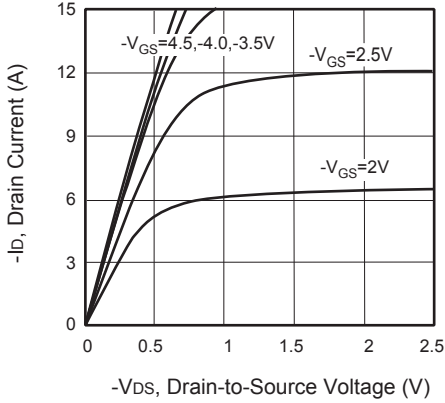

Figure 7. Output Characteristics

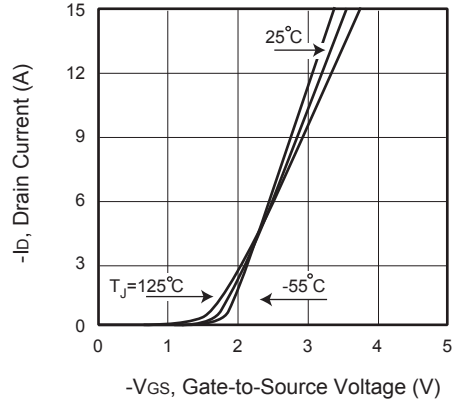

Figure 8. Transfer Characteristics

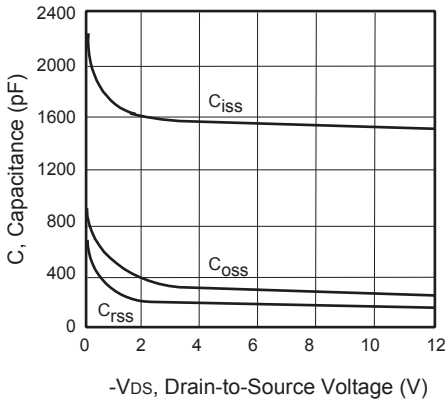

Figure 9. Capacitance

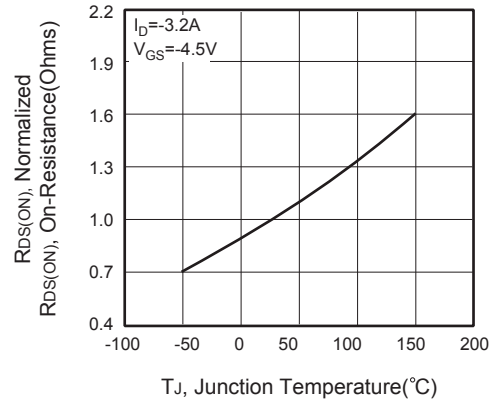

Figure 10. On-Resistance Variation with Temperature

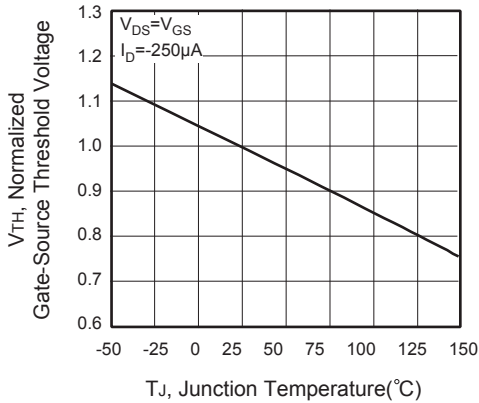

Figure 11. Gate Threshold Variation with Temperature

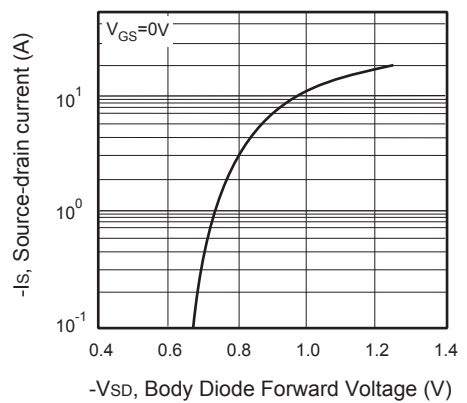

Figure 12. Body Diode Forward Voltage Variation with Source Current



N-CHANNEL

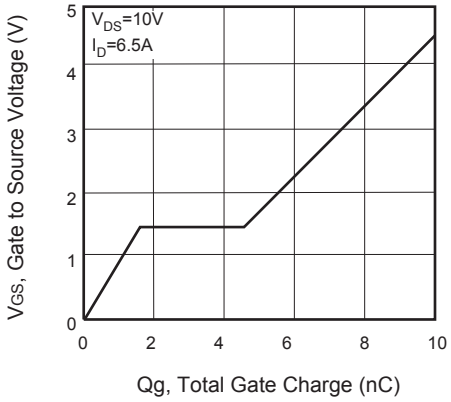

Figure 13. Gate Charge

P-CHANNEL

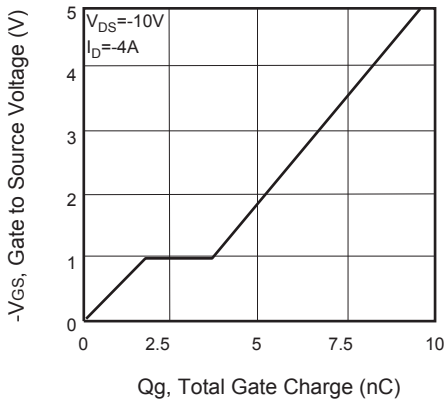

Figure 15. Gate Charge

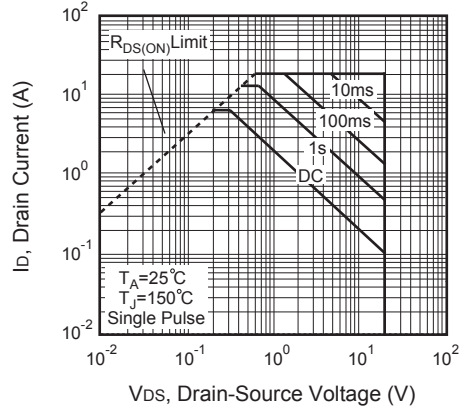

Figure 14. Maximum Safe Operating Area

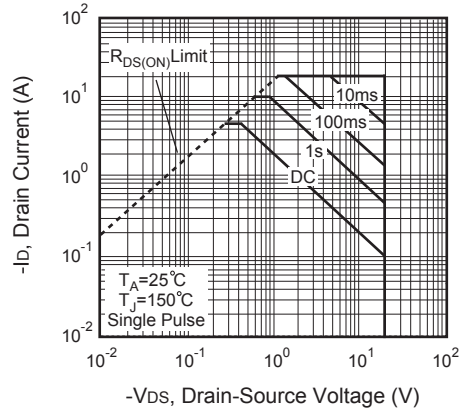

Figure 16. Maximum Safe Operating Area

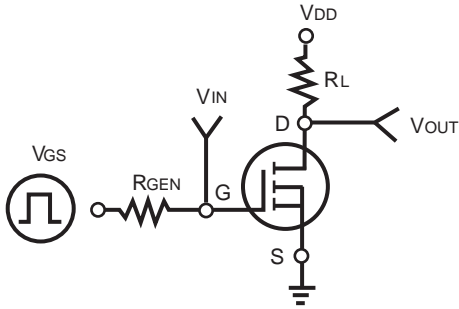

Figure 17. Switching Test Circuit

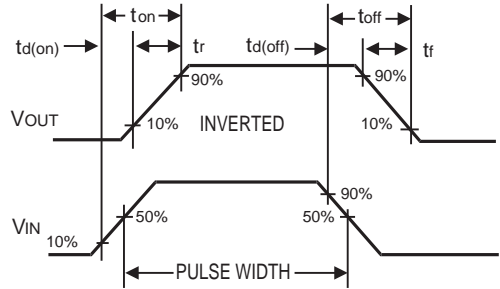

Figure 18. Switching Waveforms

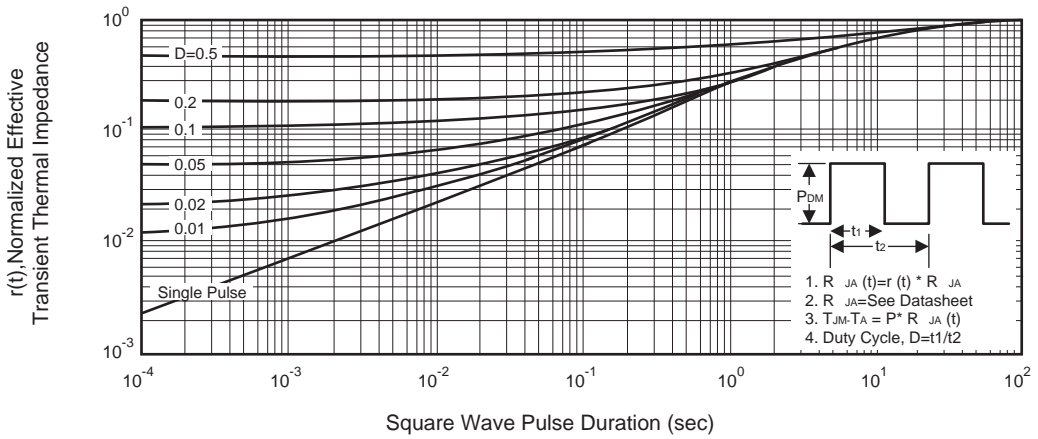

Figure 19. Normalized Thermal Transient Impedance Curve