

# CEM8434

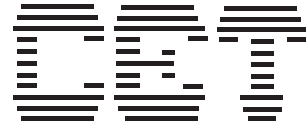

March 1998

## P-Channel Enhancement Mode Field Effect Transistor

5

### FEATURES

- -20V , -6.5A ,  $R_{DS(ON)}=35m\Omega$  @  $V_{GS}=-4.5V$ .  
 $R_{DS(ON)}=60m\Omega$  @  $V_{GS}=-2.5V$ .
- Super high dense cell design for extremely low  $R_{DS(ON)}$ .
- High power and current handing capability.
- Surface Mount Package.

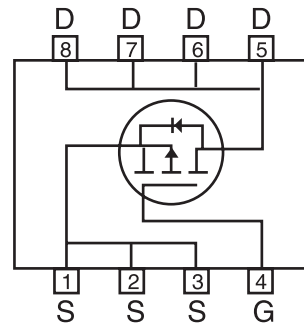
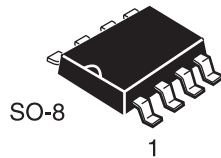

### ABSOLUTE MAXIMUM RATINGS ( $T_A=25^{\circ}C$ unless otherwise noted)

Parameter	Symbol	Limit	Unit
Drain-Source Voltage	$V_{DS}$	-20	V
Gate-Source Voltage	$V_{GS}$	$\pm 8$	V
Drain Current-Continuous <sup>a</sup> @ $T_J=125^{\circ}C$ -Pulsed <sup>b</sup>	$I_D$	$\pm 6.5$	A
	$I_{DM}$	$\pm 20$	A
Drain-Source Diode Forward Current <sup>a</sup>	$I_S$	-2.1	A
Maximum Power Dissipation <sup>a</sup>	$P_D$	2.5	W
Operating Junction and Storage Temperature Range	$T_J, T_{STG}$	-55 to 150	$^{\circ}C$

### THERMAL CHARACTERISTICS

Thermal Resistance, Junction-to-Ambient <sup>a</sup>	$R_{\theta JA}$	50	$^{\circ}C/W$
--	-----------------	----	---------------

# CEM8434

## ELECTRICAL CHARACTERISTICS (T<sub>A</sub>=25°C unless otherwise noted)

5

Parameter	Symbol	Condition	Min	Typ <sup>c</sup>	Max	Unit
<b>OFF CHARACTERISTICS</b>						
Drain-Source Breakdown Voltage	BV <sub>DSS</sub>	V <sub>GS</sub> =0V, I <sub>D</sub> =-250μA	-20	29		V
Zero Gate Voltage Drain Current	I <sub>DSS</sub>	V <sub>DS</sub> =-16V, V <sub>GS</sub> =0V			-1	μA
Gate-Body Leakage	I <sub>GSS</sub>	V <sub>GS</sub> =±8V, V <sub>DS</sub> =0V			±100	nA
<b>ON CHARACTERISTICS<sup>b</sup></b>						
Gate Threshold Voltage	V <sub>GS(th)</sub>	V <sub>DS</sub> =V <sub>GS</sub> , I <sub>D</sub> = -250μA	-0.4	-0.8	-1	V
Drain-Source On-State Resistance	R <sub>DS(ON)</sub>	V <sub>GS</sub> = -4.5V, I <sub>D</sub> = -6.5A		26	35	mΩ
		V <sub>GS</sub> = -2.5V, I <sub>D</sub> = -2.5A		50	60	mΩ
On-State Drain Current	I <sub>D(ON)</sub>	V <sub>DS</sub> = -5V, V <sub>GS</sub> = -4.5V	-15			A
Forward Transconductance	g <sub>FS</sub>	V <sub>DS</sub> = -10V, I <sub>D</sub> = -6.5A		18		S
<b>DYNAMIC CHARACTERISTICS<sup>c</sup></b>						
Input Capacitance	C <sub>ISS</sub>	V <sub>DS</sub> = -10V, V <sub>GS</sub> = 0V f = 1.0MHz		2101	2750	pF
Output Capacitance	C <sub>OSS</sub>			853	1120	pF
Reverse Transfer Capacitance	C <sub>RSS</sub>			212	280	pF
<b>SWITCHING CHARACTERISTICS<sup>c</sup></b>						
Turn-On Delay Time	t <sub>D(ON)</sub>	V <sub>D</sub> = -6V, I <sub>D</sub> = -1A, V <sub>GS</sub> = -4.5V, R <sub>GEN</sub> = 6Ω		15	40	ns
Rise Time	t <sub>r</sub>			35	80	ns
Turn-Off Delay Time	t <sub>D(OFF)</sub>			210	300	ns
Fall Time	t <sub>f</sub>			50	120	ns
Total Gate Charge	Q <sub>g</sub>	V <sub>DS</sub> = -5V, I <sub>D</sub> = -6.5A, V <sub>GS</sub> = -4.5V		40	80	nC
Gate-Source Charge	Q <sub>gs</sub>			5		nC
Gate-Drain Charge	Q <sub>gd</sub>			11		nC

# CEM8434

## ELECTRICAL CHARACTERISTICS ( $T_A=25^\circ\text{C}$ unless otherwise noted)

5

Parameter	Symbol	Condition	Min	Typ <sup>c</sup>	Max	Unit
<b>DRAIN-SOURCE DIODE CHARACTERISTICS<sup>b</sup></b>						
Diode Forward Voltage	$V_{SD}$	$V_{GS} = 0V, I_s = -2.1A$		-0.77	-1.2	V

### Notes

- a. Surface Mounted on FR4 Board,  $t \leq 10\text{sec}$ .
- b. Pulse Test: Pulse Width  $\leq 300 \mu\text{s}$ , Duty Cycle  $\leq 2\%$ .
- c. Guaranteed by design, not subject to production testing.

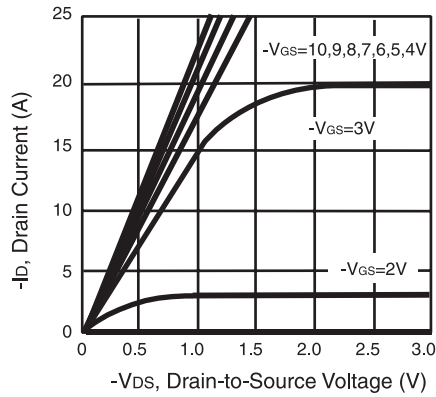

Figure 1. Output Characteristics

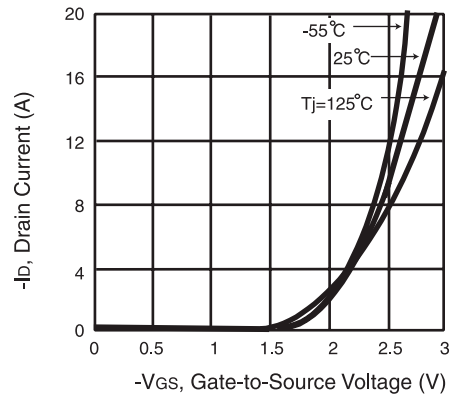

Figure 2. Transfer Characteristics

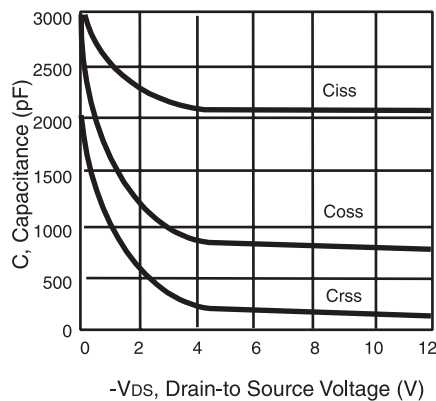

Figure 3. Capacitance

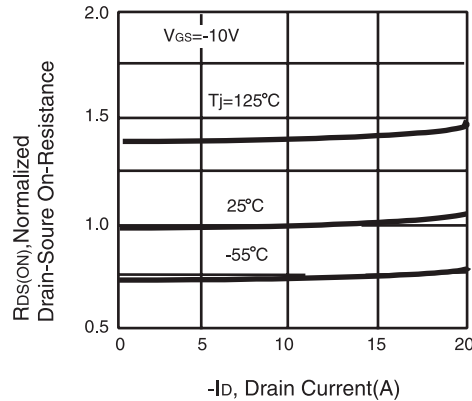
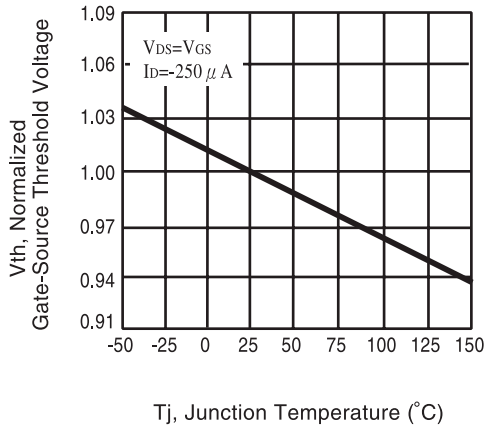

Figure 4. On-Resistance Variation with Drain Current and Temperature

# CEM8434

5



**Figure 5. Gate Threshold Variation with Temperature**

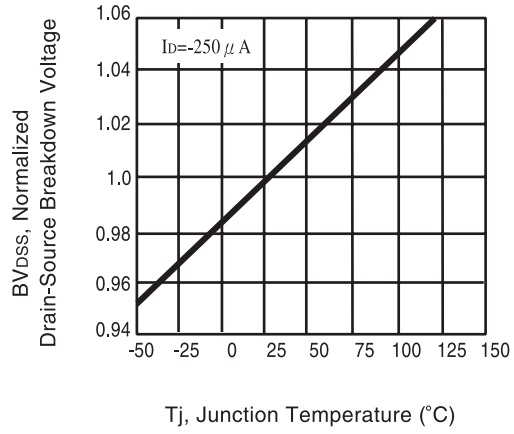

**Figure 6. Breakdown Voltage Variation with Temperature**

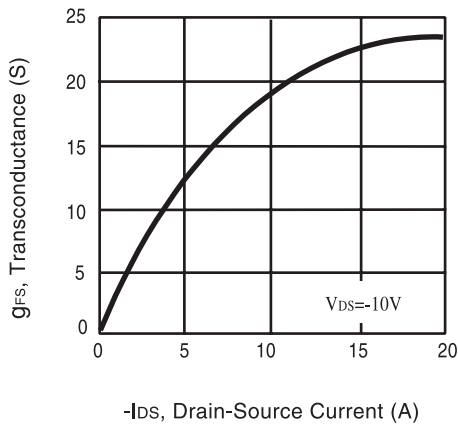

**Figure 7. Transconductance Variation with Drain Current**

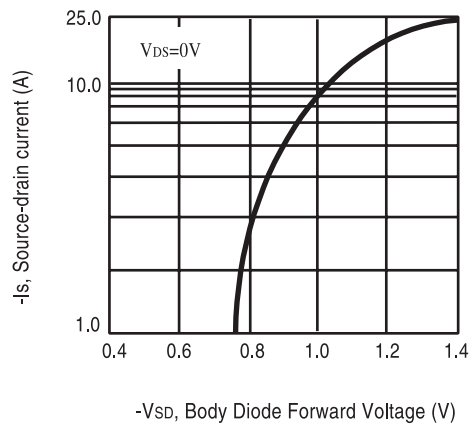

**Figure 8. Body Diode Forward Voltage Variation with Source Current**

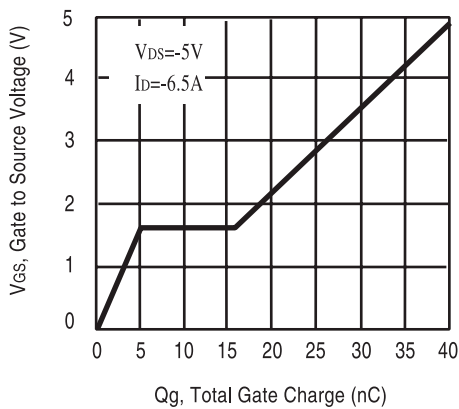

**Figure 9. Gate Charge**

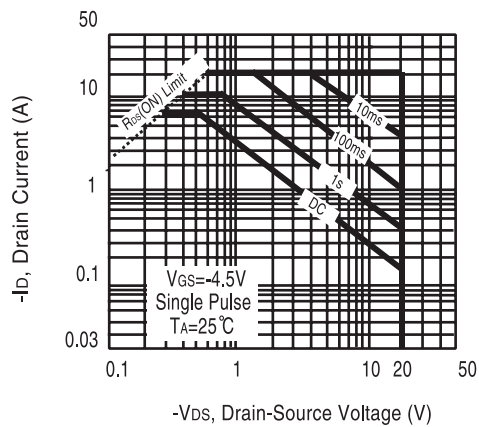

**Figure 10. Maximum Safe Operating Area**

# CEM8434

5

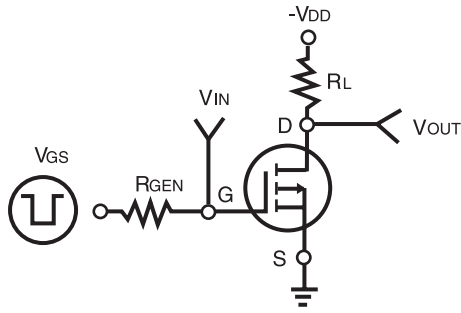

Figure 11. Switching Test Circuit

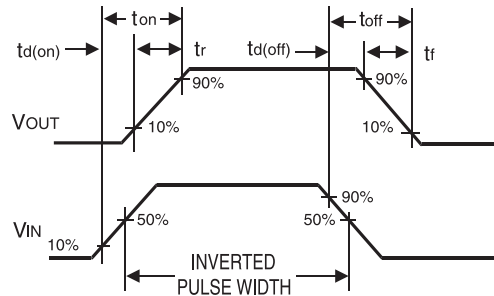

Figure 12. Switching Waveforms

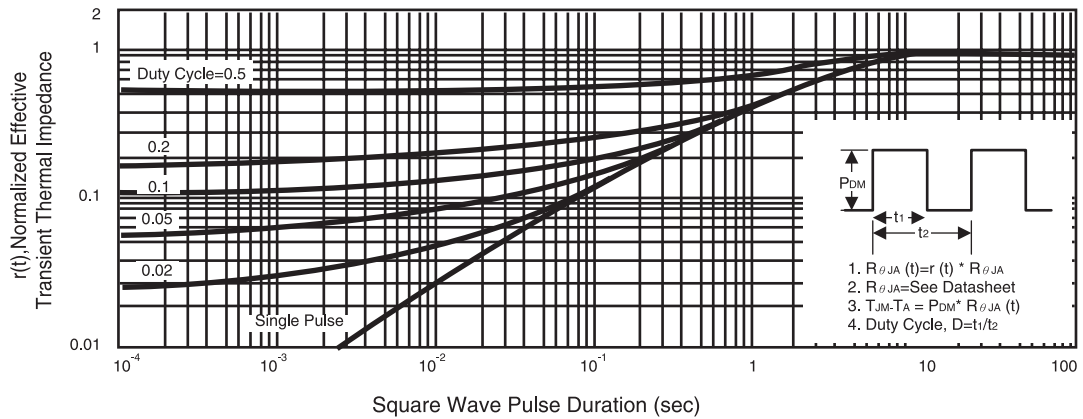

Figure 13. Normalized Thermal Transient Impedance Curve