



CEP02N6A/CEB02N6A CEI02N6A/CEF02N6A

N-Channel Enhancement Mode Field Effect Transistor

FEATURES

Type	V _{DSS}	R _{DS(ON)}	I _D	@V _{GS}
CEP02N6A	650V	7.5Ω	1.5A	10V
CEB02N6A	650V	7.5Ω	1.5A	10V
CEI02N6A	650V	7.5Ω	1.5A	10V
CEF02N6A	650V	7.5Ω	1.5A ^e	10V

- Super high dense cell design for extremely low R_{DS(ON)}.
- High power and current handling capability.
- Lead free product is acquired.
- TO-220 & TO-263 & TO-262 package & TO-220F full-pak for through hole.

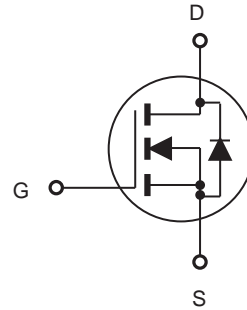
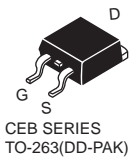

ABSOLUTE MAXIMUM RATINGS $T_C = 25^\circ\text{C}$ unless otherwise noted

Parameter	Symbol	Limit		Units
		TO-220/263/262	TO-220F	
Drain-Source Voltage	V _{DS}	650		V
Gate-Source Voltage	V _{GS}	±30		V
Drain Current-Continuous	I _D	1.5	1.5 ^e	A
Drain Current-Pulsed ^a	I _{DM} ^f	4.5	4.5 ^e	A
Maximum Power Dissipation @ T _C = 25°C - Derate above 25°C	P _D	42	28	W
		0.33	0.22	W/°C
Single Pulsed Avalanche Energy ^d	E _{AS}	90	90	mJ
Single Pulsed Avalanche Current ^d	I _{AS}	1.4	1.4	A
Operating and Store Temperature Range	T _J , T _{stg}	-55 to 150		°C

Thermal Characteristics

Parameter	Symbol	Limit		Units
Thermal Resistance, Junction-to-Case	R _{θJC}	3	4.5	°C/W
Thermal Resistance, Junction-to-Ambient	R _{θJA}	62.5	65	°C/W



CEP02N6A/CEB02N6A CEI02N6A/CEF02N6A

Electrical Characteristics $T_C = 25^\circ\text{C}$ unless otherwise noted

4

Parameter	Symbol	Test Condition	Min	Typ	Max	Units
Off Characteristics						
Drain-Source Breakdown Voltage	BV_{DSS}	$V_{GS} = 0V, I_D = 250\mu A$	650			V
Zero Gate Voltage Drain Current	I_{DSS}	$V_{DS} = 600V, V_{GS} = 0V$			25	μA
Gate Body Leakage Current, Forward	I_{GSSF}	$V_{GS} = 30V, V_{DS} = 0V$			100	nA
Gate Body Leakage Current, Reverse	I_{GSSR}	$V_{GS} = -30V, V_{DS} = 0V$			-100	nA
On Characteristics^b						
Gate Threshold Voltage	$V_{GS(th)}$	$V_{GS} = V_{DS}, I_D = 250\mu A$	2		4	V
Static Drain-Source On-Resistance	$R_{DS(on)}$	$V_{GS} = 10V, I_D = 0.8A$		5.8	7.5	Ω
Forward Transconductance	g_{FS}	$V_{DS} = 50V, I_D = 0.8A$		0.8		S
Dynamic Characteristics^c						
Input Capacitance	C_{iss}	$V_{DS} = 25V, V_{GS} = 0V, f = 1.0\text{ MHz}$		176		pF
Output Capacitance	C_{oss}			48		pF
Reverse Transfer Capacitance	C_{rss}			21		pF
Switching Characteristics^c						
Turn-On Delay Time	$t_{d(on)}$	$V_{DD} = 300V, I_D = 1A, V_{GS} = 10V, R_{GEN} = 18\Omega$		11	27	ns
Turn-On Rise Time	t_r			16	40	ns
Turn-Off Delay Time	$t_{d(off)}$			28	35	ns
Turn-Off Fall Time	t_f			16	40	ns
Total Gate Charge	Q_g	$V_{DS} = 480V, I_D = 1A, V_{GS} = 10V$		15	21	nC
Gate-Source Charge	Q_{gs}			2.4		nC
Gate-Drain Charge	Q_{gd}			8.7		nC
Drain-Source Diode Characteristics and Maximum Ratings						
Drain-Source Diode Forward Current	I_S^g				1.5	A
Drain-Source Diode Forward Voltage ^b	V_{SD}	$V_{GS} = 0V, I_S = 0.8A$			1.5	V
Notes : a.Repetitive Rating : Pulse width limited by maximum junction temperature . b.Pulse Test : Pulse Width $\leq 300\mu s$, Duty Cycle $\leq 2\%$. c.Guaranteed by design, not subject to production testing. d.L = 60mH, $I_{AS} = 1.4A, V_{DD} = 50V, R_G = 25\Omega$, Starting $T_J = 25^\circ\text{C}$. e.Limited only by maximum temperature allowed . f.Pulse width limited by safe operating area . g.Full package $I_{S(max)} = 1.2A$.						



CEP02N6A/CEB02N6A CEI02N6A/CEF02N6A

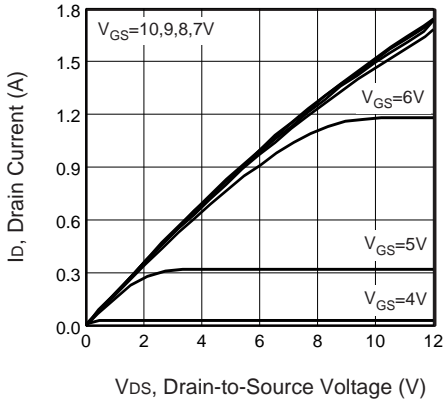

Figure 1. Output Characteristics

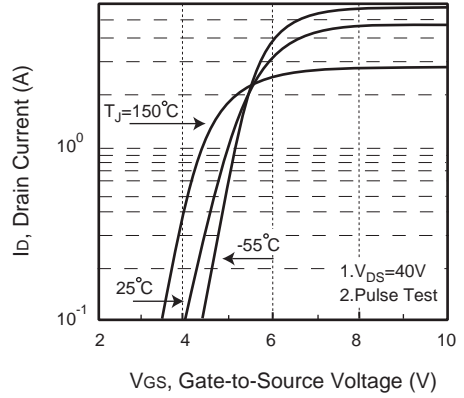

Figure 2. Transfer Characteristics

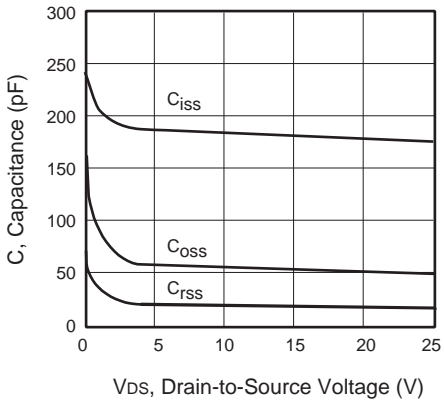

Figure 3. Capacitance

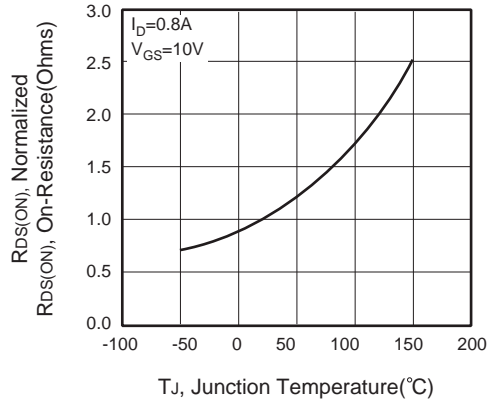

Figure 4. On-Resistance Variation with Temperature

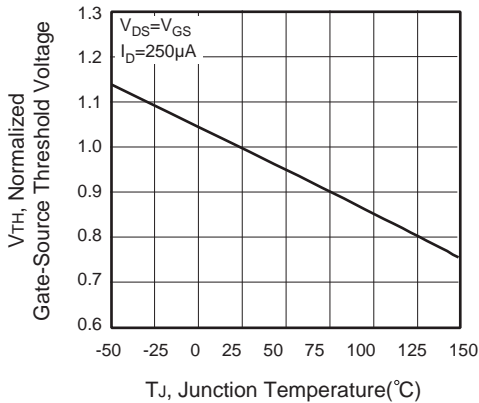

Figure 5. Gate Threshold Variation with Temperature

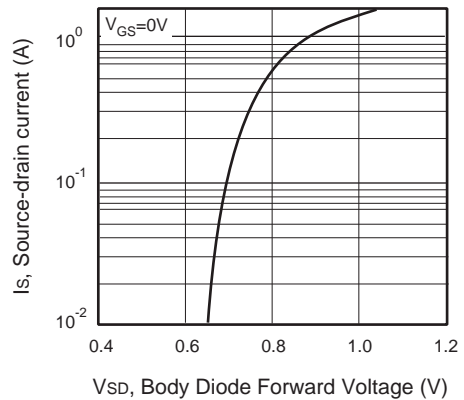

Figure 6. Body Diode Forward Voltage Variation with Source Current



CEP02N6A/CEB02N6A CEI02N6A/CEF02N6A

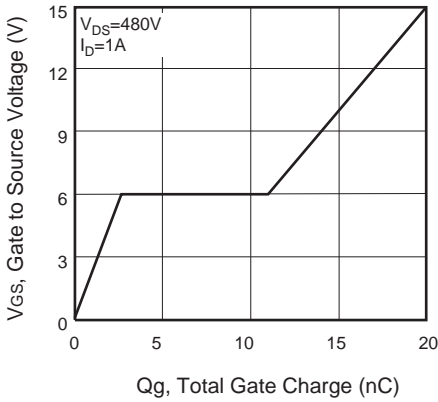

Figure 7. Gate Charge

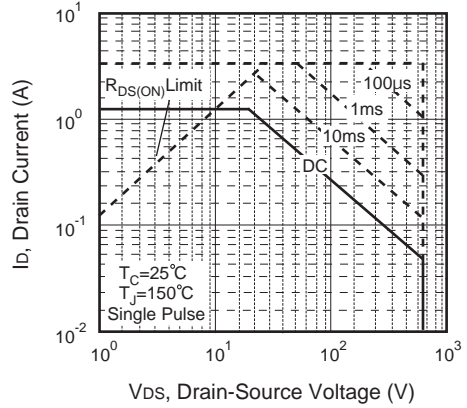

Figure 8. Maximum Safe Operating Area

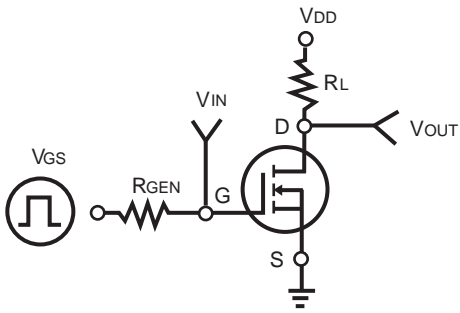

Figure 9. Switching Test Circuit



Figure 10. Switching Waveforms

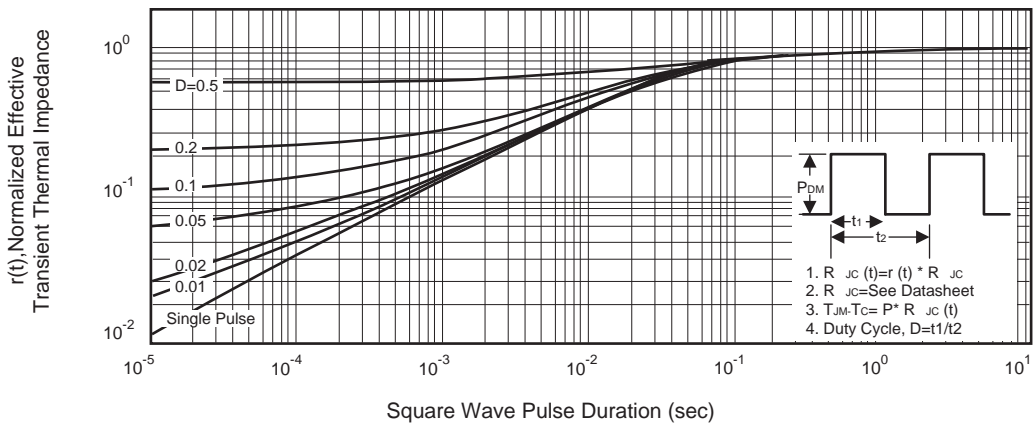

Figure 11. Normalized Thermal Transient Impedance Curve