



# CEP02N7/CEB02N7 CEI02N7/CEF02N7

## N-Channel Enhancement Mode Field Effect Transistor

### FEATURES

Type	V <sub>DSS</sub>	R <sub>DS(ON)</sub>	I <sub>D</sub>	@V <sub>GS</sub>
CEP02N7	700V	6.6Ω	1.9A	10V
CEB02N7	700V	6.6Ω	1.9A	10V
CEI02N7	700V	6.6Ω	1.9A	10V
CEF02N7	700V	6.6Ω	1.9A <sup>e</sup>	10V

- Super high dense cell design for extremely low R<sub>DS(ON)</sub>.
- High power and current handling capability.
- Lead free product is acquired.
- TO-220 & TO-263 & TO-262 package & TO-220F full-pak for through hole.

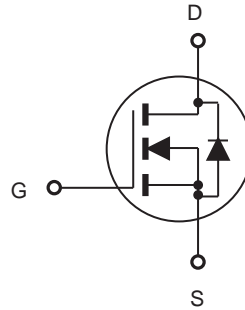
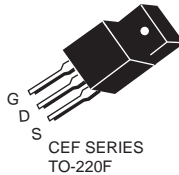
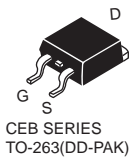

### ABSOLUTE MAXIMUM RATINGS $T_C = 25^\circ\text{C}$ unless otherwise noted

Parameter	Symbol	Limit		Units
		TO-220/263/262	TO-220F	
Drain-Source Voltage	V <sub>DS</sub>	700		V
Gate-Source Voltage	V <sub>GS</sub>	±30		V
Drain Current-Continuous	I <sub>D</sub>	1.9	1.9 <sup>e</sup>	A
Drain Current-Pulsed <sup>a</sup>	I <sub>DM</sub> <sup>f</sup>	6	6 <sup>e</sup>	A
Maximum Power Dissipation @ T <sub>C</sub> = 25°C - Derate above 25°C	P <sub>D</sub>	60	32	W
		0.48	0.26	W/°C
Single Pulsed Avalanche Energy <sup>d</sup>	E <sub>AS</sub>	125	125	mJ
Repetitive Avalanche Current <sup>a</sup>	I <sub>AR</sub>	2	2	A
Repetitive Avalanche Energy <sup>a</sup>	E <sub>AR</sub>	5.4	5.4	mJ
Operating and Store Temperature Range	T <sub>J</sub> , T <sub>stg</sub>	-55 to 150		°C

### Thermal Characteristics

Parameter	Symbol	Limit		Units
Thermal Resistance, Junction-to-Case	R <sub>θJC</sub>	2.1	3.9	°C/W
Thermal Resistance, Junction-to-Ambient	R <sub>θJA</sub>	62.5	65	°C/W



# CEP02N7/CEB02N7 CEI02N7/CEF02N7

## Electrical Characteristics $T_C = 25^\circ\text{C}$ unless otherwise noted

4

Parameter	Symbol	Test Condition	Min	Typ	Max	Units
<b>Off Characteristics</b>						
Drain-Source Breakdown Voltage	$BV_{DSS}$	$V_{GS} = 0V, I_D = 250\mu A$	700			V
Zero Gate Voltage Drain Current	$I_{DSS}$	$V_{DS} = 700V, V_{GS} = 0V$			25	$\mu A$
Gate Body Leakage Current, Forward	$I_{GSSF}$	$V_{GS} = 30V, V_{DS} = 0V$			100	nA
Gate Body Leakage Current, Reverse	$I_{GSSR}$	$V_{GS} = -30V, V_{DS} = 0V$			-100	nA
<b>On Characteristics<sup>b</sup></b>						
Gate Threshold Voltage	$V_{GS(th)}$	$V_{GS} = V_{DS}, I_D = 250\mu A$	2		4	V
Static Drain-Source On-Resistance	$R_{DS(on)}$	$V_{GS} = 10V, I_D = 1A$		5.5	6.6	$\Omega$
Forward Transconductance	$g_{FS}$	$V_{DS} = 50V, I_D = 1A$		0.7		S
<b>Dynamic Characteristics<sup>c</sup></b>						
Input Capacitance	$C_{iss}$	$V_{DS} = 25V, V_{GS} = 0V, f = 1.0\text{ MHz}$		250		pF
Output Capacitance	$C_{oss}$			50		pF
Reverse Transfer Capacitance	$C_{rss}$			30		pF
<b>Switching Characteristics<sup>c</sup></b>						
Turn-On Delay Time	$t_{d(on)}$	$V_{DD} = 300V, I_D = 2A, V_{GS} = 10V, R_{GEN} = 18\Omega$		19	35	ns
Turn-On Rise Time	$t_r$			26	50	ns
Turn-Off Delay Time	$t_{d(off)}$			34	70	ns
Turn-Off Fall Time	$t_f$			15	40	ns
Total Gate Charge	$Q_g$	$V_{DS} = 480V, I_D = 2A, V_{GS} = 10V$		14	20	nC
Gate-Source Charge	$Q_{gs}$			2.5		nC
Gate-Drain Charge	$Q_{gd}$			8.6		nC
<b>Drain-Source Diode Characteristics and Maximum Ratings</b>						
Drain-Source Diode Forward Current	$I_S^g$				1.9	A
Drain-Source Diode Forward Voltage <sup>b</sup>	$V_{SD}^h$	$V_{GS} = 0V, I_S = 2A$			1.5	V
<b>Notes :</b> a.Repetitive Rating : Pulse width limited by maximum junction temperature . b.Pulse Test : Pulse Width $\leq 300\mu s$ , Duty Cycle $\leq 2\%$ . c.Guaranteed by design, not subject to production testing. d.L = 60mH, $I_{AS} = 2.0A, V_{DD} = 50V, R_G = 25\Omega$ , Starting $T_J = 25^\circ\text{C}$ . e.Limited only by maximum temperature allowed . f.Pulse width limited by safe operating area . g.Full package $I_{S(max)} = 1.4A$ . h.Full package $V_{SD}$ test condition $I_S = 1.5A, V_{SD(Max)} = 1.6V$ .						



# CEP02N7/CEB02N7 CEI02N7/CEF02N7

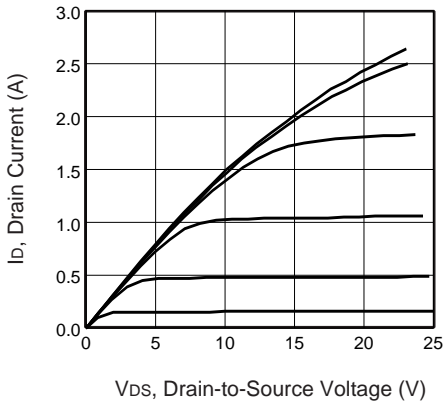

Figure 1. Output Characteristics

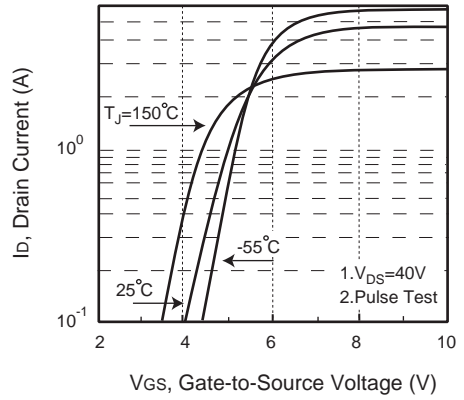

Figure 2. Transfer Characteristics

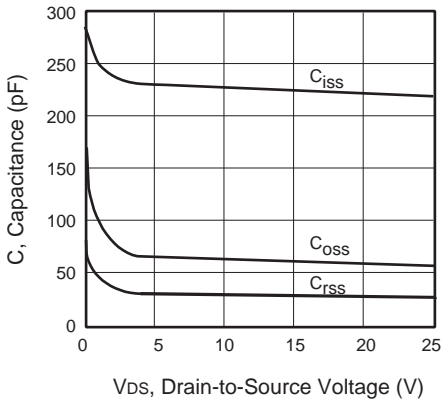

Figure 3. Capacitance

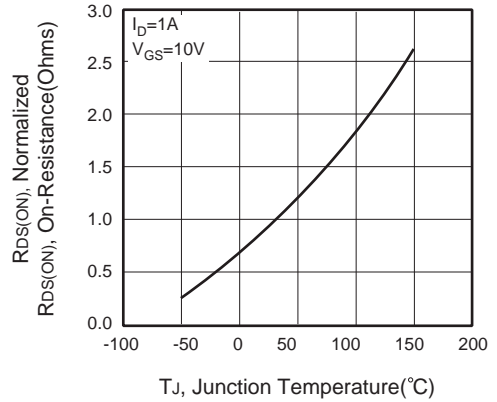

Figure 4. On-Resistance Variation with Temperature

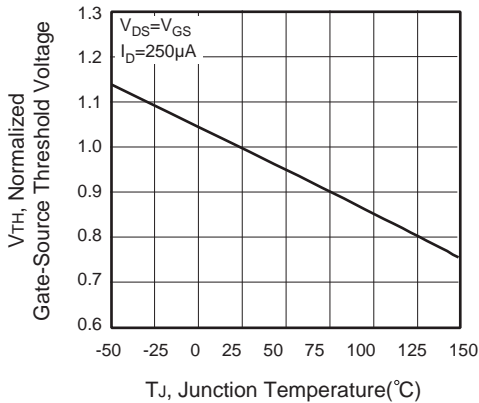

Figure 5. Gate Threshold Variation with Temperature

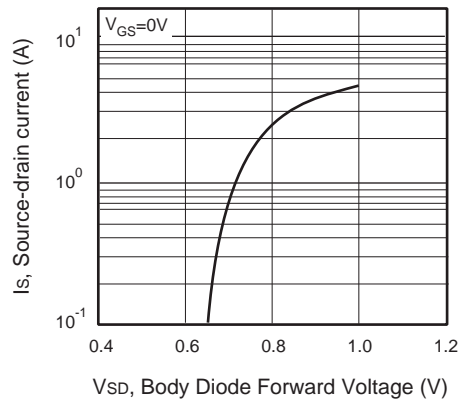

Figure 6. Body Diode Forward Voltage Variation with Source Current



# CEP02N7/CEB02N7 CEI02N7/CEF02N7

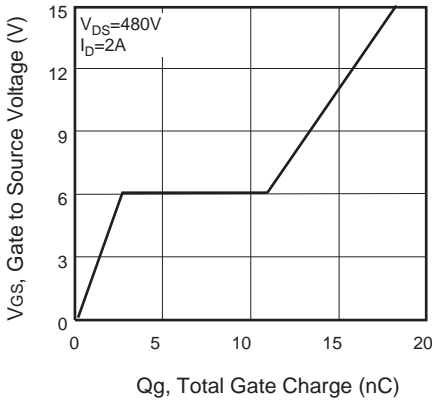

Figure 7. Gate Charge

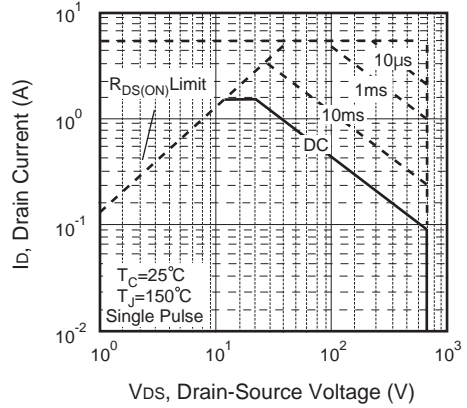

Figure 8. Maximum Safe Operating Area

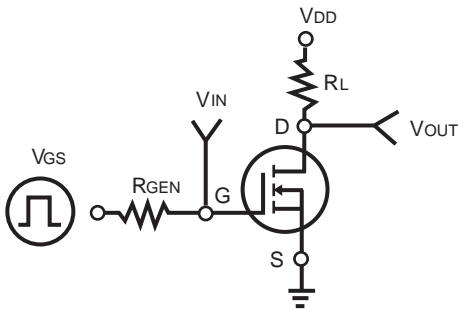

Figure 9. Switching Test Circuit

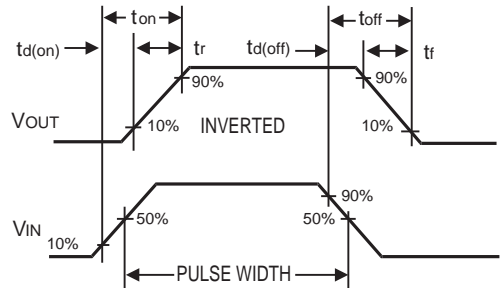

Figure 10. Switching Waveforms

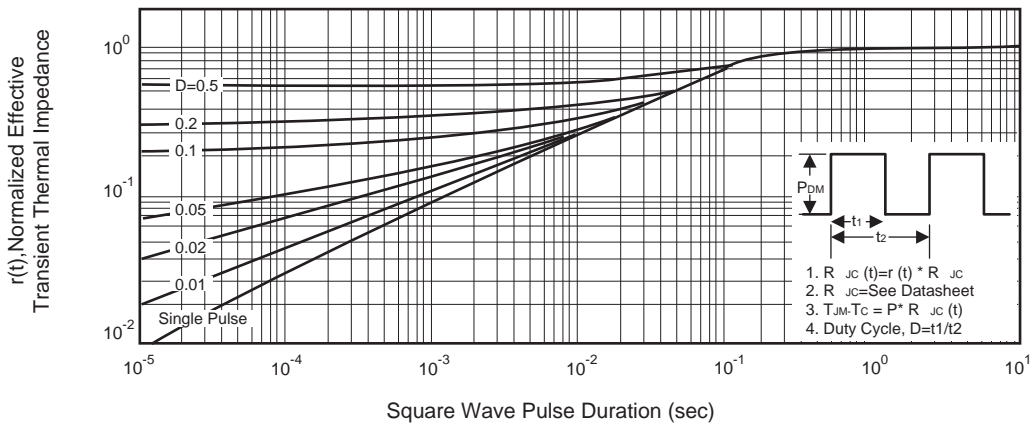

Figure 11. Normalized Thermal Transient Impedance Curve