



CEP30N3/CEB30N3 CEF30N3

N-Channel Enhancement Mode Field Effect Transistor

PRELIMINARY

FEATURES

Type	V _{DSS}	R _{DS(ON)}	I _D	@V _{GS}
CEP30N3	300V	110mΩ	30A	10V
CEB30N3	300V	110mΩ	30A	10V
CEF30N3	300V	110mΩ	30A ^e	10V

- Super high dense cell design for extremely low R_{DS(ON)}.
- High power and current handling capability.
- Lead-free plating ; RoHS compliant.

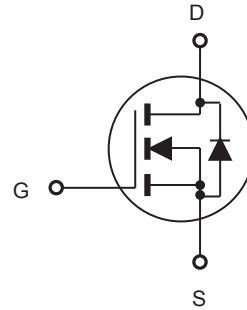
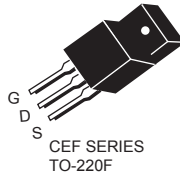

ABSOLUTE MAXIMUM RATINGS $T_C = 25^\circ\text{C}$ unless otherwise noted

Parameter	Symbol	Limit		Units
		TO-220/263	TO-220F	
Drain-Source Voltage	V _{DS}	300		V
Gate-Source Voltage	V _{GS}	±30		V
Drain Current-Continuous	I _D	30	30 ^e	A
Drain Current-Pulsed ^a	I _{DM} ^f	120	120 ^e	A
Maximum Power Dissipation @ T _C = 25°C - Derate above 25°C	P _D	227	74	W
		1.8	0.6	W/°C
Single Pulsed Avalanche Energy ^d	E _{AS}	450		mJ
Single Pulsed Avalanche Current ^d	I _{AS}	30		A
Operating and Store Temperature Range	T _J , T _{stg}	-55 to 150		°C

Thermal Characteristics

Parameter	Symbol	Limit		Units
Thermal Resistance, Junction-to-Case	R _{θJC}	0.55	1.7	°C/W
Thermal Resistance, Junction-to-Ambient	R _{θJA}	62.5	65	°C/W

This is preliminary information on a new product in development now .
Details are subject to change without notice .

Rev 1. 2012.Dec
<http://www.cetsemi.com>



CEP30N3/CEB30N3 CEF30N3

Electrical Characteristics $T_C = 25^\circ\text{C}$ unless otherwise noted

Parameter	Symbol	Test Condition	Min	Typ	Max	Units
Off Characteristics						
Drain-Source Breakdown Voltage	BV_{DSS}	$V_{GS} = 0V, I_D = 250\mu A$	300			V
Zero Gate Voltage Drain Current	I_{DSS}	$V_{DS} = 300V, V_{GS} = 0V$			1	μA
Gate Body Leakage Current, Forward	I_{GSSF}	$V_{GS} = 30V, V_{DS} = 0V$			100	nA
Gate Body Leakage Current, Reverse	I_{GSSR}	$V_{GS} = -30V, V_{DS} = 0V$			-100	nA
On Characteristics^b						
Gate Threshold Voltage	$V_{GS(th)}$	$V_{GS} = V_{DS}, I_D = 250\mu A$	2		4	V
Static Drain-Source On-Resistance	$R_{DS(on)}$	$V_{GS} = 10V, I_D = 15A$		85	110	m Ω
Dynamic Characteristics^c						
Input Capacitance	C_{iss}	$V_{DS} = 25V, V_{GS} = 0V,$ $f = 1.0\text{ MHz}$		2800		pF
Output Capacitance	C_{oss}			390		pF
Reverse Transfer Capacitance	C_{rss}			5		pF
Switching Characteristics^c						
Turn-On Delay Time	$t_{d(on)}$	$V_{DD} = 150V, I_D = 32A,$ $V_{GS} = 10V, R_{GEN} = 25\Omega$		40		ns
Turn-On Rise Time	t_r			23		ns
Turn-Off Delay Time	$t_{d(off)}$			140		ns
Turn-Off Fall Time	t_f			20		ns
Total Gate Charge	Q_g	$V_{DS} = 240V, I_D = 32A,$ $V_{GS} = 10V$		64		nC
Gate-Source Charge	Q_{gs}			18		nC
Gate-Drain Charge	Q_{gd}			22		nC
Drain-Source Diode Characteristics and Maximum Ratings						
Drain-Source Diode Forward Current	I_S^g				30	A
Drain-Source Diode Forward Voltage ^b	V_{SD}	$V_{GS} = 0V, I_S = 30A^h$			1.5	V
Notes : □ a.Repetitive Rating : Pulse width limited by maximum junction temperature . b.Pulse Test : Pulse Width $\leq 300\mu s$, Duty Cycle $\leq 2\%$. □ c.Guaranteed by design, not subject to production testing. □ d.L = 1mH, $I_{AS} = 30A, V_{OD} = 50V, R_G = 25\Omega$, Starting $T_J = 25\text{ C}^\circ$. e.Limited only by maximum temperature allowed . f.Pulse width limited by safe operating area . g.Full package $I_{S(max)} = 17A$. h.Full package V_{SD} test condition $I_S = 17A$.						



CEP30N3/CEB30N3 CEF30N3

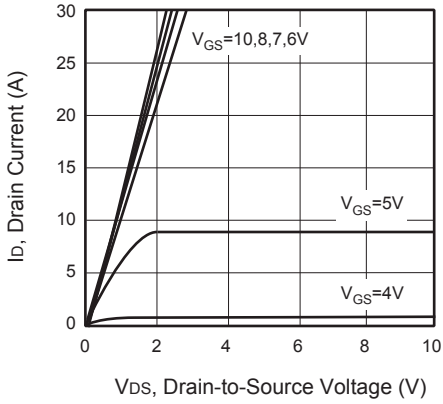

Figure 1. Output Characteristics

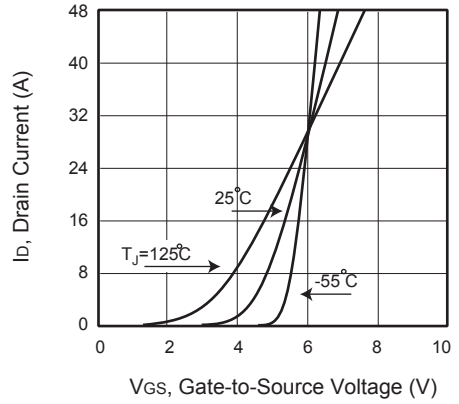

Figure 2. Transfer Characteristics

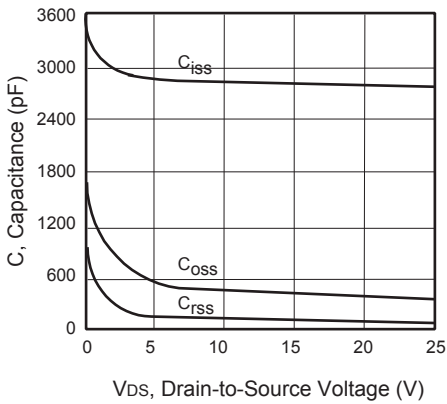

Figure 3. Capacitance

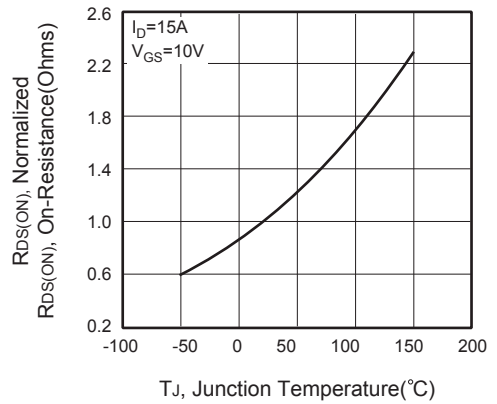

Figure 4. On-Resistance Variation with Temperature

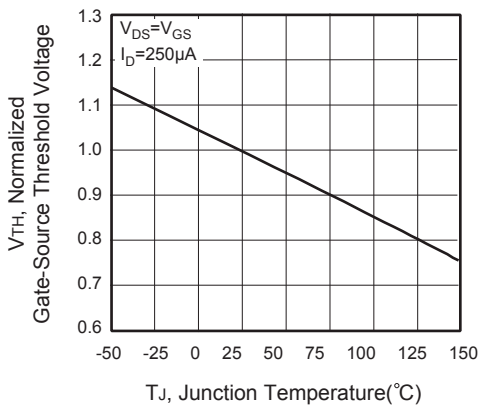

Figure 5. Gate Threshold Variation with Temperature

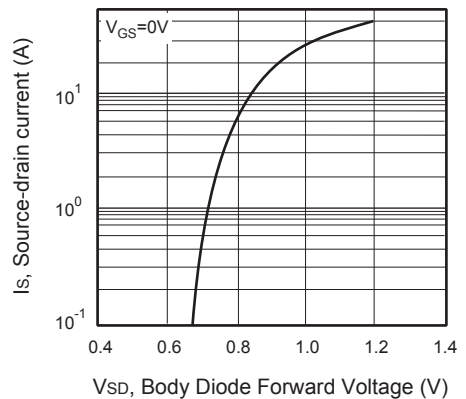

Figure 6. Body Diode Forward Voltage Variation with Source Current



CEP30N3/CEB30N3 CEF30N3

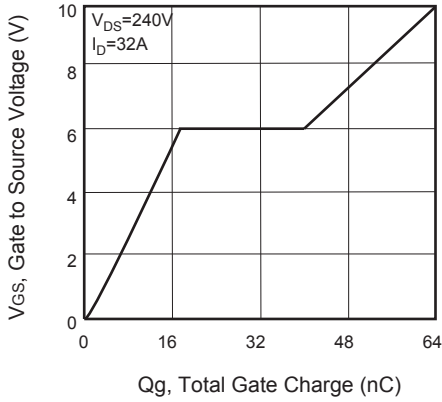

Figure 7. Gate Charge

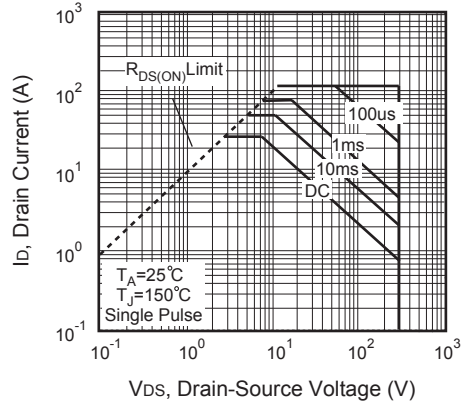

Figure 8. Maximum Safe Operating Area

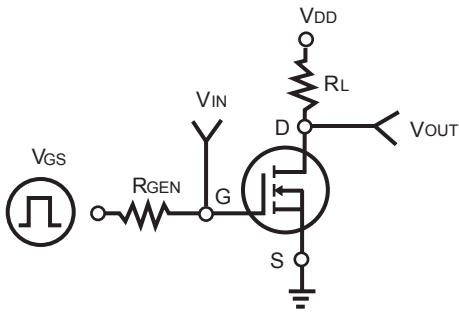

Figure 9. Switching Test Circuit

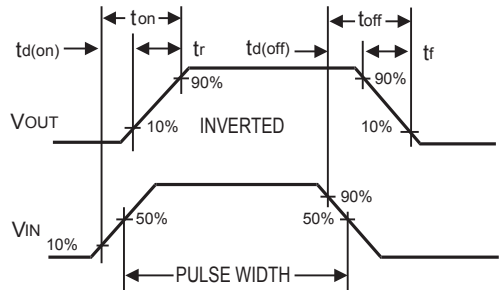

Figure 10. Switching Waveforms

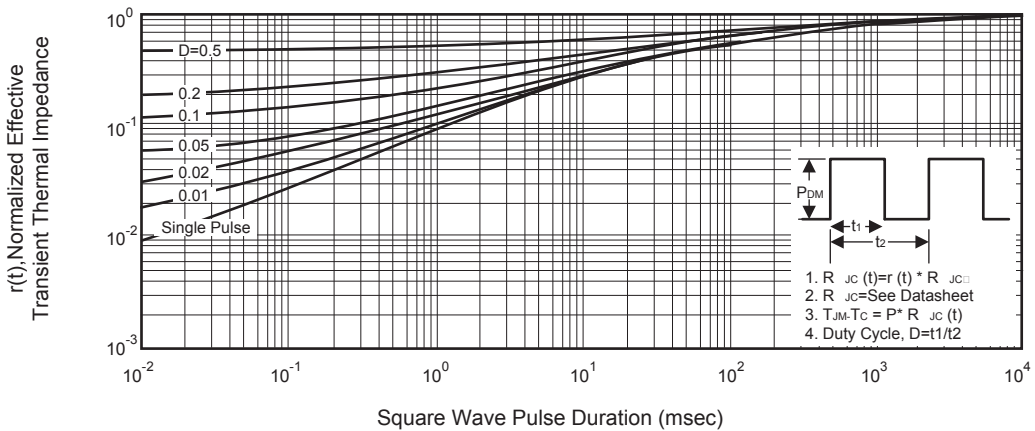

Figure 11. Normalized Thermal Transient Impedance Curve