



CEP3120/CEB3120

N-Channel Enhancement Mode Field Effect Transistor

FEATURES

- 30V, 40A, $R_{DS(ON)} = 15m\Omega @ V_{GS} = 10V$.
 $R_{DS(ON)} = 22m\Omega @ V_{GS} = 4.5V$.
- Super high dense cell design for extremely low $R_{DS(ON)}$.
- High power and current handing capability.
- Lead free product is acquired.
- TO-220 & TO-263 package.

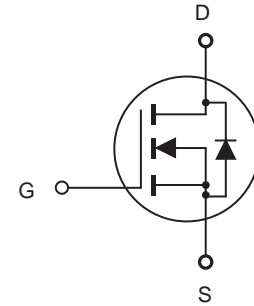

ABSOLUTE MAXIMUM RATINGS $T_C = 25^\circ C$ unless otherwise noted

Parameter	Symbol	Limit	Units
Drain-Source Voltage	V_{DS}	30	V
Gate-Source Voltage	V_{GS}	± 20	V
Drain Current-Continuous	I_D	40	A
Drain Current-Pulsed ^a	I_{DM}	160	A
Maximum Power Dissipation @ $T_C = 25^\circ C$ - Derate above $25^\circ C$	P_D	43	W
		0.29	W/ $^\circ C$
Operating and Store Temperature Range	T_J, T_{stg}	-55 to 175	$^\circ C$

Thermal Characteristics

Parameter	Symbol	Limit	Units
Thermal Resistance, Junction-to-Case	$R_{\theta JC}$	3.5	$^\circ C/W$
Thermal Resistance, Junction-to-Ambient	$R_{\theta JA}$	62.5	$^\circ C/W$



CEP3120/CEB3120

Electrical Characteristics $T_A = 25^\circ\text{C}$ unless otherwise noted

Parameter	Symbol	Test Condition	Min	Typ	Max	Units
Off Characteristics						
Drain-Source Breakdown Voltage	BV_{DSS}	$V_{GS} = 0V, I_D = 250\mu A$	30			V
Zero Gate Voltage Drain Current	I_{DSS}	$V_{DS} = 30V, V_{GS} = 0V$			1	μA
Gate Body Leakage Current, Forward	I_{GSSF}	$V_{GS} = 20V, V_{DS} = 0V$			100	nA
Gate Body Leakage Current, Reverse	I_{GSSR}	$V_{GS} = -20V, V_{DS} = 0V$			-100	nA
On Characteristics ^c						
Gate Threshold Voltage	$V_{GS(th)}$	$V_{GS} = V_{DS}, I_D = 250\mu A$	1		3	V
Static Drain-Source	$R_{DS(on)}$	$V_{GS} = 10V, I_D = 40A$		11	15	$m\Omega$
On-Resistance		$V_{GS} = 4.5V, I_D = 32A$		17	22	$m\Omega$
Dynamic Characteristics ^d						
Input Capacitance	C_{iss}	$V_{DS} = 15V, V_{GS} = 0V,$ $f = 1.0\text{ MHz}$		955		pF
Output Capacitance	C_{oss}			155		pF
Reverse Transfer Capacitance	C_{rss}			75		pF
Switching Characteristics ^d						
Turn-On Delay Time	$t_{d(on)}$	$V_{DD} = 15V, I_D = 10A,$ $V_{GS} = 10V, R_{GEN} = 0.3\Omega$		13	26	ns
Turn-On Rise Time	t_r			3.4	6.8	ns
Turn-Off Delay Time	$t_{d(off)}$			30	60	ns
Turn-Off Fall Time	t_f			6.8	13.6	ns
Total Gate Charge	Q_g	$V_{DS} = 15V, I_D = 40A,$ $V_{GS} = 10V$		13.1	17.4	nC
Gate-Source Charge	Q_{gs}			2.7		nC
Gate-Drain Charge	Q_{gd}			1		nC
Drain-Source Diode Characteristics and Maximum Ratings						
Drain-Source Diode Forward Current ^b	I_S				40	A
Drain-Source Diode Forward Voltage ^c	V_{SD}	$V_{GS} = 0V, I_S = 40A$			1.3	V
Notes : a.Repetitive Rating : Pulse width limited by maximum junction temperature. b.Surface Mounted on FR4 Board, $t \leq 10\text{ sec}$. c.Pulse Test : Pulse Width $\leq 300\mu s$, Duty Cycle $\leq 2\%$. d.Guaranteed by design, not subject to production testing.						

5



CEP3120/CEB3120

5

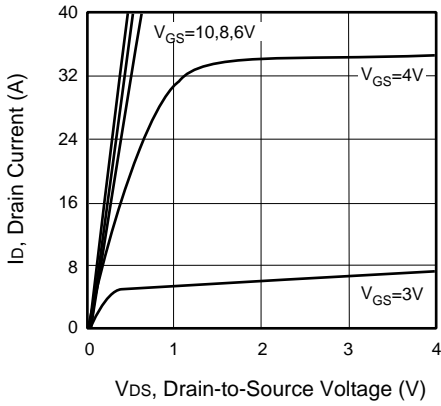

Figure 1. Output Characteristics

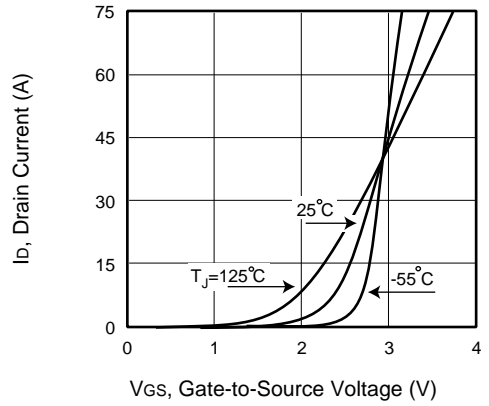

Figure 2. Transfer Characteristics

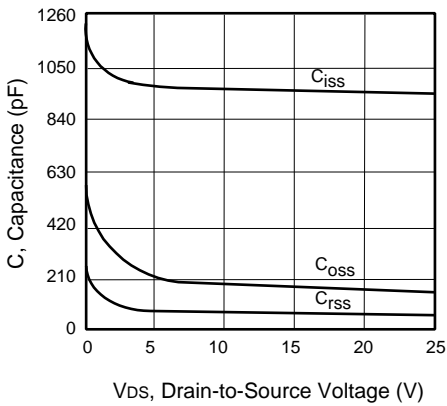

Figure 3. Capacitance

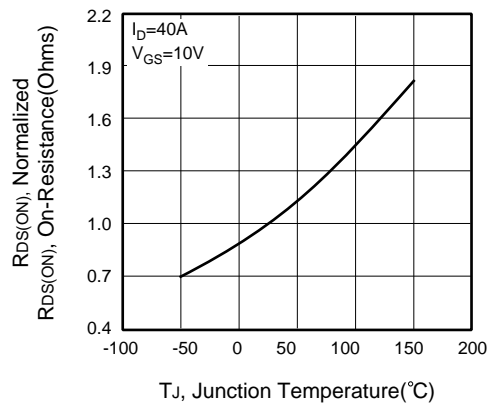

Figure 4. On-Resistance Variation with Temperature

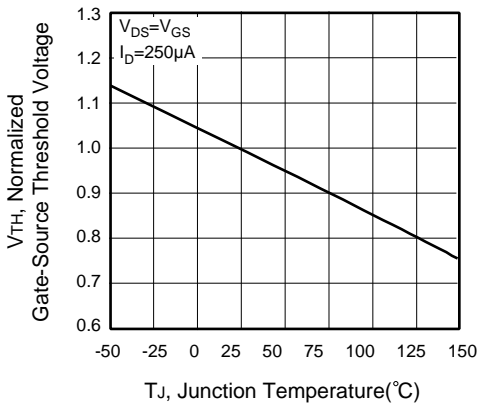

Figure 5. Gate Threshold Variation with Temperature

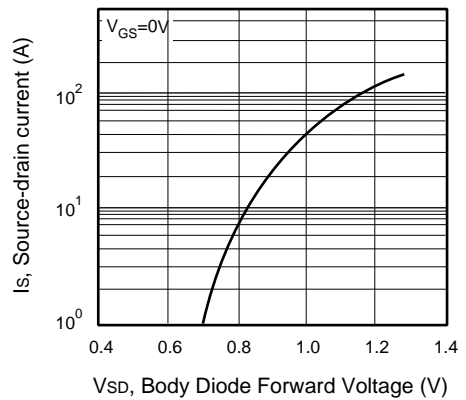

Figure 6. Body Diode Forward Voltage Variation with Source Current



CEP3120/CEB3120

6

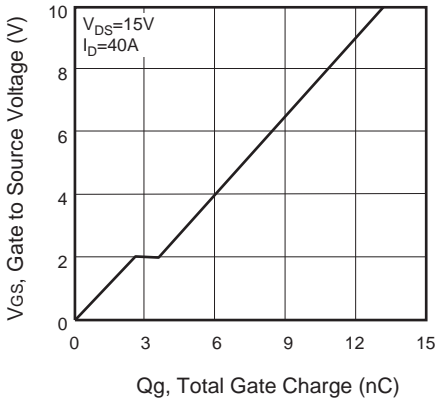

Figure 7. Gate Charge

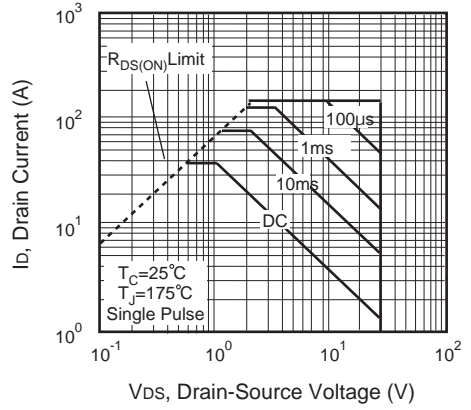

Figure 8. Maximum Safe Operating Area

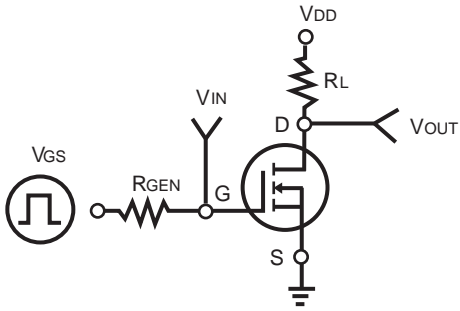

Figure 9. Switching Test Circuit

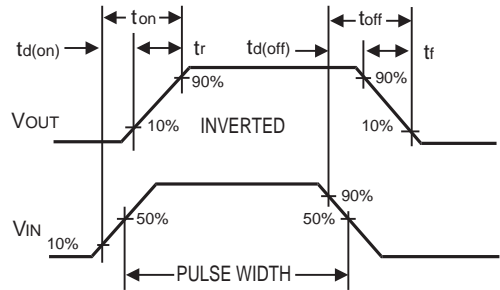

Figure 10. Switching Waveforms

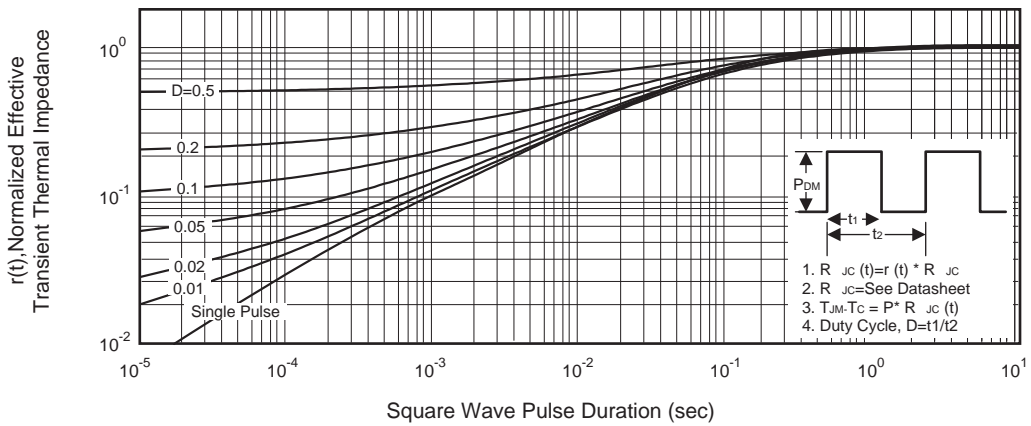

Figure 11. Normalized Thermal Transient Impedance Curve