



CEP51A3/CEB51A3

N-Channel Enhancement Mode Field Effect Transistor

FEATURES

- 30V, 48A, $R_{DS(ON)} = 16.5m\Omega$ @ $V_{GS} = 10V$.
 $R_{DS(ON)} = 28m\Omega$ @ $V_{GS} = 4.5V$.
- Super high dense cell design for extremely low $R_{DS(ON)}$.
- High power and current handing capability.
- Lead free product is acquired.
- TO-220 & TO-263 package.

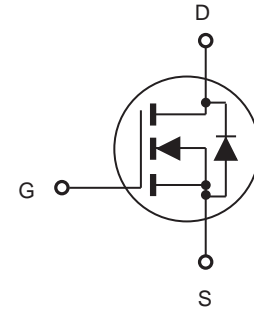

ABSOLUTE MAXIMUM RATINGS $T_C = 25^\circ C$ unless otherwise noted

Parameter	Symbol	Limit	Units
Drain-Source Voltage	V_{DS}	30	V
Gate-Source Voltage	V_{GS}	± 20	V
Drain Current-Continuous	I_D	48	A
Drain Current-Pulsed ^a	I_{DM}	160	A
Maximum Power Dissipation @ $T_C = 25^\circ C$ - Derate above $25^\circ C$	P_D	70	W
		0.48	W/ $^\circ C$
Operating and Store Temperature Range	T_J, T_{stg}	-55 to 175	$^\circ C$

Thermal Characteristics

Parameter	Symbol	Limit	Units
Thermal Resistance, Junction-to-Case	$R_{\theta JC}$	2.1	$^\circ C/W$
Thermal Resistance, Junction-to-Ambient	$R_{\theta JA}$	62.5	$^\circ C/W$



CEP51A3/CEB51A3

Electrical Characteristics $T_C = 25^\circ\text{C}$ unless otherwise noted

4

Parameter	Symbol	Test Condition	Min	Typ	Max	Units	
Off Characteristics							
Drain-Source Breakdown Voltage	BV_{DSS}	$V_{GS} = 0V, I_D = 250\mu A$	30			V	
Zero Gate Voltage Drain Current	I_{DSS}	$V_{DS} = 30V, V_{GS} = 0V$			1	μA	
Gate Body Leakage Current, Forward	I_{GSSF}	$V_{GS} = 20V, V_{DS} = 0V$			100	nA	
Gate Body Leakage Current, Reverse	I_{GSSR}	$V_{GS} = -20V, V_{DS} = 0V$			-100	nA	
On Characteristics^b							
Gate Threshold Voltage	$V_{GS(th)}$	$V_{GS} = V_{DS}, I_D = 250\mu A$	1		3	V	
Static Drain-Source On-Resistance	$R_{DS(on)}$	$V_{GS} = 10V, I_D = 20A$		13.5	16.5	$m\Omega$	
		$V_{GS} = 4.5V, I_D = 20A$		20	28	$m\Omega$	
Forward Transconductance	g_{FS}	$V_{DS} = 10V, I_D = 20A$		26		S	
Dynamic Characteristics^c							
Input Capacitance	C_{iss}	$V_{DS} = 25V, V_{GS} = 0V, f = 1.0\text{ MHz}$		1340		pF	
Output Capacitance	C_{oss}				232		pF
Reverse Transfer Capacitance	C_{rss}				82		pF
Switching Characteristics^c							
Turn-On Delay Time	$t_{d(on)}$	$V_{DD} = 15V, I_D = 20A, V_{GS} = 4.5V, R_{GEN} = 4.7\Omega$		16	40	ns	
Turn-On Rise Time	t_r			4.4	13	ns	
Turn-Off Delay Time	$t_{d(off)}$			31	62	ns	
Turn-Off Fall Time	t_f			4.5	14	ns	
Total Gate Charge	Q_g				13	23	nC
Gate-Source Charge	Q_{gs}	$V_{DS} = 24V, I_D = 40A, V_{GS} = 5V$		4		nC	
Gate-Drain Charge	Q_{gd}			4		nC	
Drain-Source Diode Characteristics and Maximum Ratings							
Drain-Source Diode Forward Current	I_S				48	A	
Drain-Source Diode Forward Voltage ^b	V_{SD}	$V_{GS} = 0V, I_S = 40A$			1.3	V	
Notes : a.Repetitive Rating : Pulse width limited by maximum junction temperature. b.Pulse Test : Pulse Width $\leq 300\mu s$, Duty Cycle $\leq 2\%$. c.Guaranteed by design, not subject to production testing.							



CEP51A3/CEB51A3

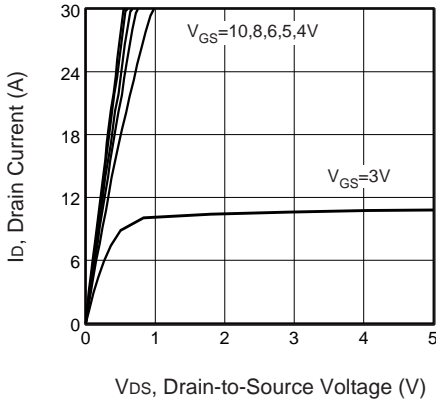

Figure 1. Output Characteristics

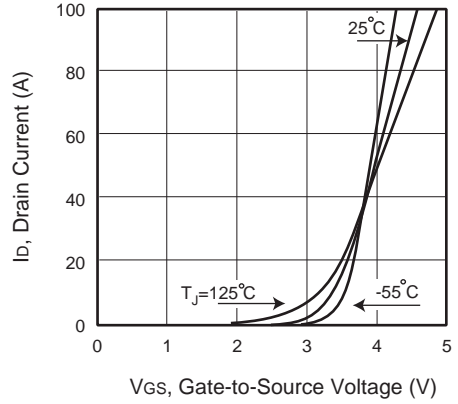

Figure 2. Transfer Characteristics

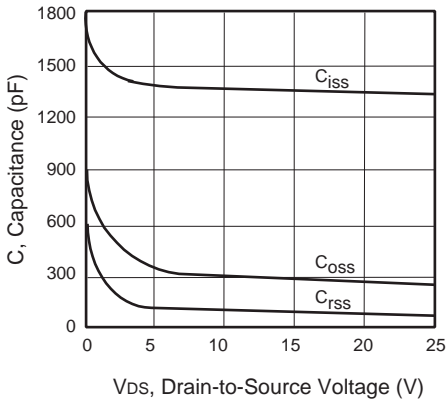

Figure 3. Capacitance

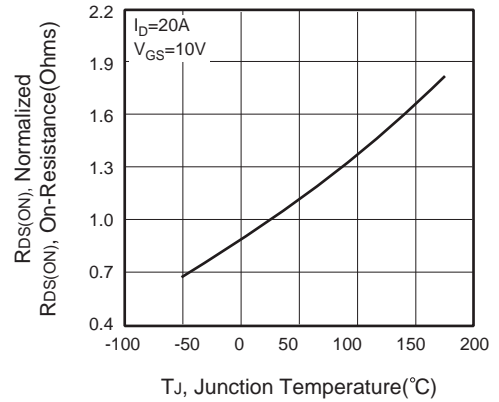

Figure 4. On-Resistance Variation with Temperature

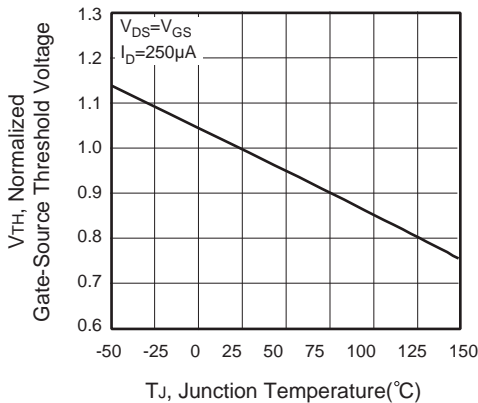

Figure 5. Gate Threshold Variation with Temperature

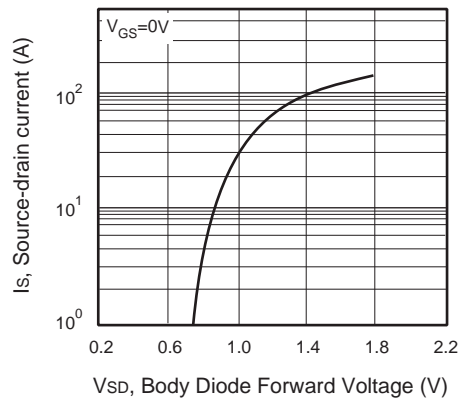

Figure 6. Body Diode Forward Voltage Variation with Source Current



CEP51A3/CEB51A3

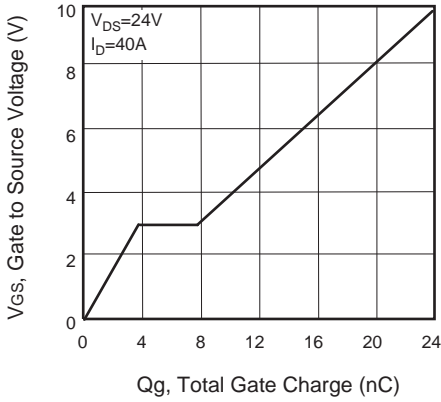

Figure 7. Gate Charge

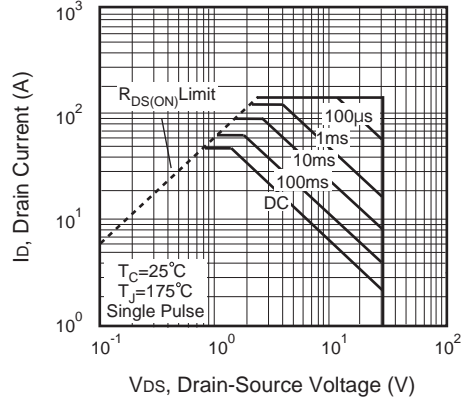

Figure 8. Maximum Safe Operating Area

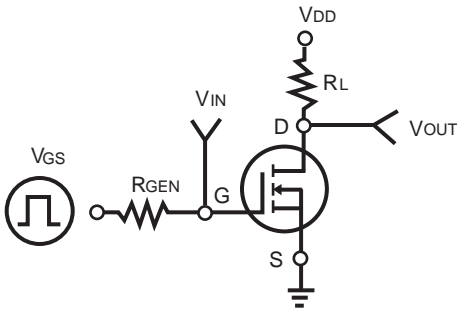

Figure 9. Switching Test Circuit

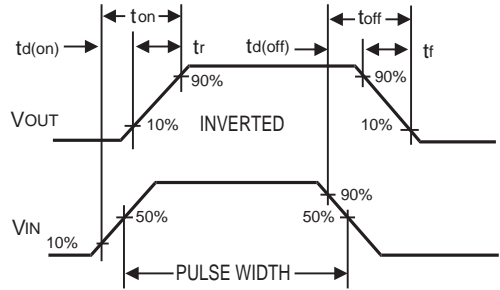

Figure 10. Switching Waveforms

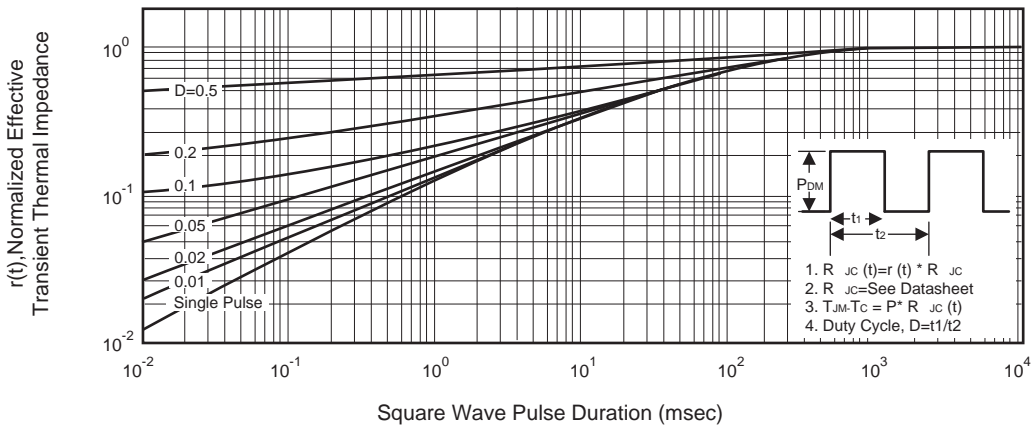

Figure 11. Normalized Thermal Transient Impedance Curve