

CEP6031L/CEB6031L

March 1998

N-Channel Logic Level Enhancement Mode Field Effect Transistor

4

FEATURES

- 30V , 60A , $R_{DS(ON)}=10m\Omega$ @ $V_{GS}=10V$.
 $R_{DS(ON)}=15m\Omega$ @ $V_{GS}=4.5V$.
- Super high dense cell design for extremely low $R_{DS(ON)}$.
- High power and current handling capability.
- TO-220 & TO-263 package.

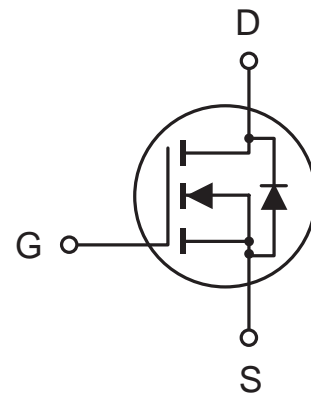

ABSOLUTE MAXIMUM RATINGS ($T_c=25^\circ C$ unless otherwise noted)

Parameter	Symbol	Limit	Unit
Drain-Source Voltage	V_{DS}	30	V
Gate-Source Voltage	V_{GS}	± 16	V
Drain Current-Continuous @ $T_J=125^\circ C$ -Pulsed	I_D	60	A
	I_{DM}	180	A
Drain-Source Diode Forward Current	I_S	60	A
Maximum Power Dissipation @ $T_c=25^\circ C$ Derate above $25^\circ C$	P_D	75	W
		0.5	W/ $^\circ C$
Operating and Storage Temperature Range	T_J, T_{STG}	-65 to 175	$^\circ C$

THERMAL CHARACTERISTICS

Thermal Resistance, Junction-to-Case	$R_{\theta JC}$	2	$^\circ C/W$
Thermal Resistance, Junction-to-Ambient	$R_{\theta JA}$	62.5	$^\circ C/W$

CEP6031L/CEB6031L

4

ELECTRICAL CHARACTERISTICS (Tc=25°C unless otherwise noted)

Parameter	Symbol	Condition	Min	Typ	Max	Unit
OFF CHARACTERISTICS						
Drain-Source Breakdown Voltage	BV _{DSS}	V _{GS} = 0V, I _D = 250μA	30			V
Zero Gate Voltage Drain Current	I _{DSS}	V _{DS} = 24V, V _{GS} = 0V			1	μA
Gate-Body Leakage	I _{GSS}	V _{GS} = ±16V, V _{DS} = 0V			±100	nA
ON CHARACTERISTICS^a						
Gate Threshold Voltage	V _{GS(th)}	V _{DS} = V _{GS} , I _D = 250μA	1	1.6	3	V
Drain-Source On-State Resistance	R _{DS(ON)}	V _{GS} = 10V, I _D = 26A		8.0	10	mΩ
		V _{GS} = 4.5V, I _D = 21A		11.5	15	mΩ
On-State Drain Current	I _{D(ON)}	V _{GS} = 10V, V _{DS} = 10V	60			A
Forward Transconductance	g _{FS}	V _{DS} = 10V, I _D = 26A		32		S
DYNAMIC CHARACTERISTICS^b						
Input Capacitance	C _{ISS}	V _{DS} = 15V, V _{GS} = 0V f = 1.0MHz		1800		pF
Output Capacitance	C _{OSS}			700		pF
Reverse Transfer Capacitance	C _{RSS}			200		pF
SWITCHING CHARACTERISTICS^b						
Turn-On Delay Time	t _{D(ON)}	V _{DD} = 15V, I _D = 60A, V _{GS} = 10V, R _{GEN} = 24Ω		6	16	ns
Rise Time	t _r			120	250	ns
Turn-Off Delay Time	t _{D(OFF)}			40	90	ns
Fall Time	t _f			105	200	ns
Total Gate Charge	Q _g	V _{DS} = 12V, I _D = 58A, V _{GS} = 10V		46	51	nC
Gate-Source Charge	Q _{gs}			6		nC
Gate-Drain Charge	Q _{gd}			14		nC

CEP6031L/CEB6031L

ELECTRICAL CHARACTERISTICS ($T_c=25^\circ\text{C}$ unless otherwise noted)

4

Parameter	Symbol	Condition	Min	Typ	Max	Unit
DRAIN-SOURCE DIODE CHARACTERISTICS ^a						
Diode Forward Voltage	V_{SD}	$V_{GS} = 0V, I_s = 26A$		0.9	1.3	V

Notes

- a. Pulse Test: Pulse Width $\leq 300 \mu s$, Duty Cycle $\leq 2\%$.
- b. Guaranteed by design, not subject to production testing.

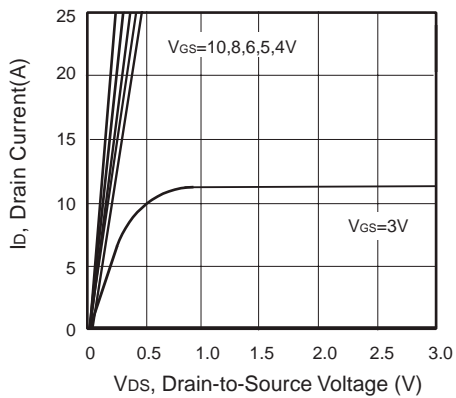

Figure 1. Output Characteristics

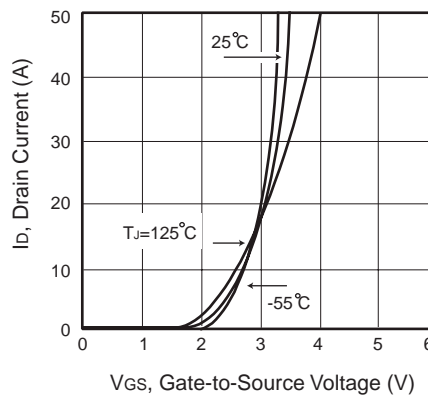

Figure 2. Transfer Characteristics

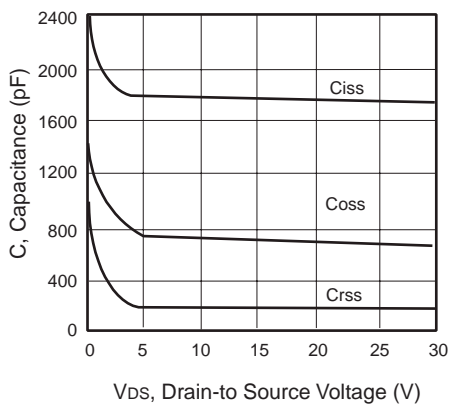

Figure 3. Capacitance

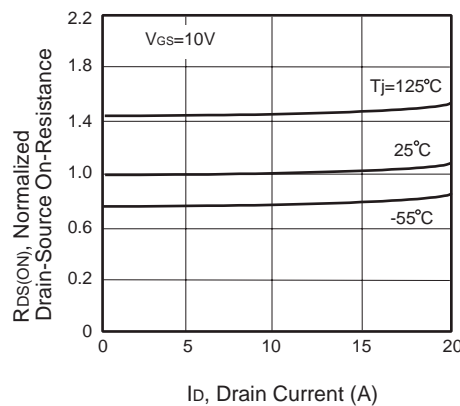

Figure 4. On-Resistance Variation with Drain Current and Temperature

CEP6031L/CEB6031L

4

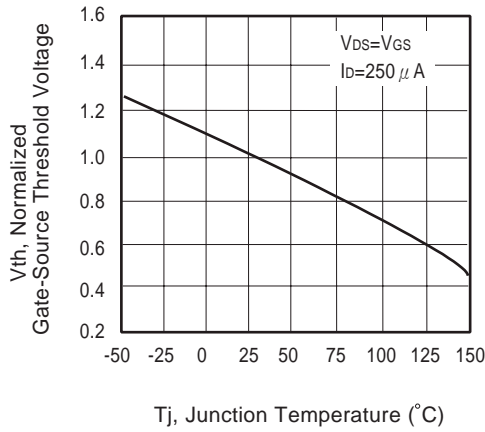

Figure 5. Gate Threshold Variation with Temperature

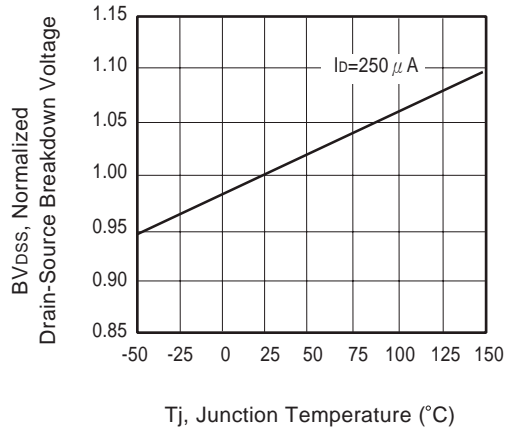

Figure 6. Breakdown Voltage Variation with Temperature

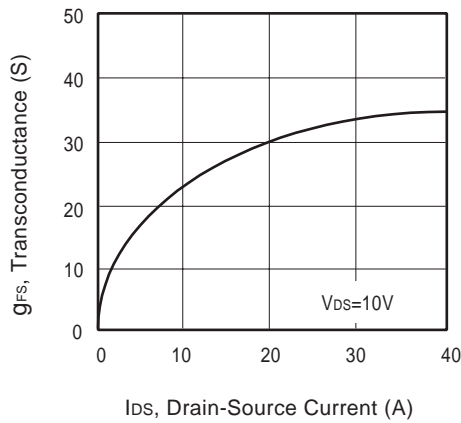

Figure 7. Transconductance Variation with Drain Current

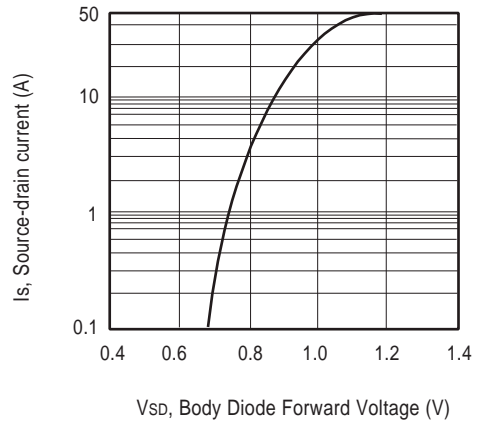

Figure 8. Body Diode Forward Voltage Variation with Source Current

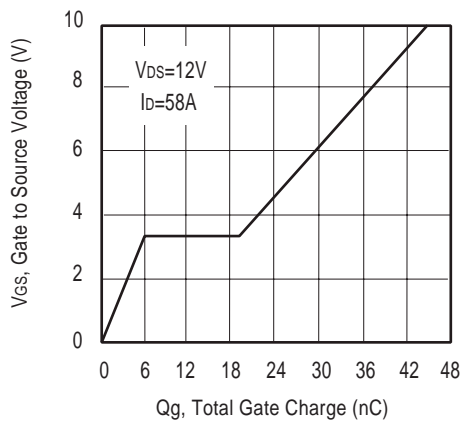

Figure 9. Gate Charge

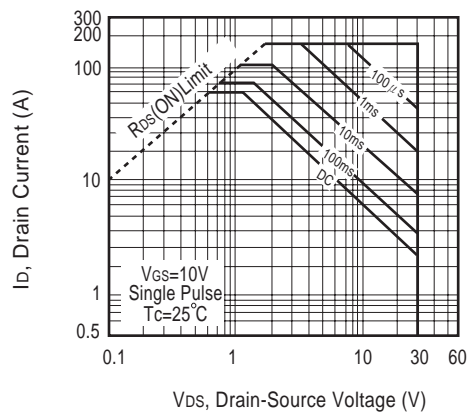

Figure 10. Maximum Safe Operating Area

CEP6031L/CEB6031L

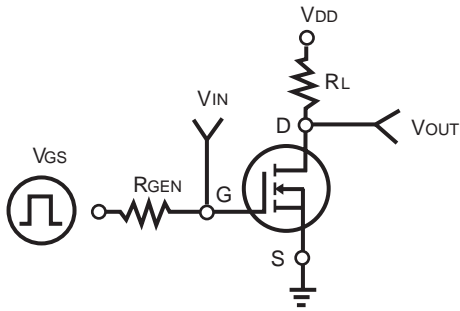

Figure 11. Switching Test Circuit

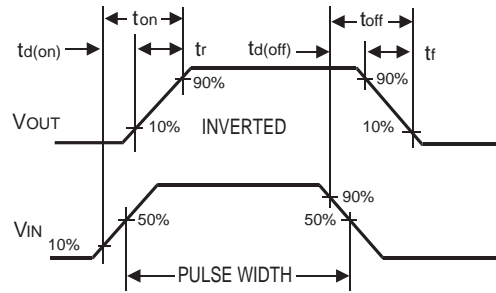

Figure 12. Switching Waveforms

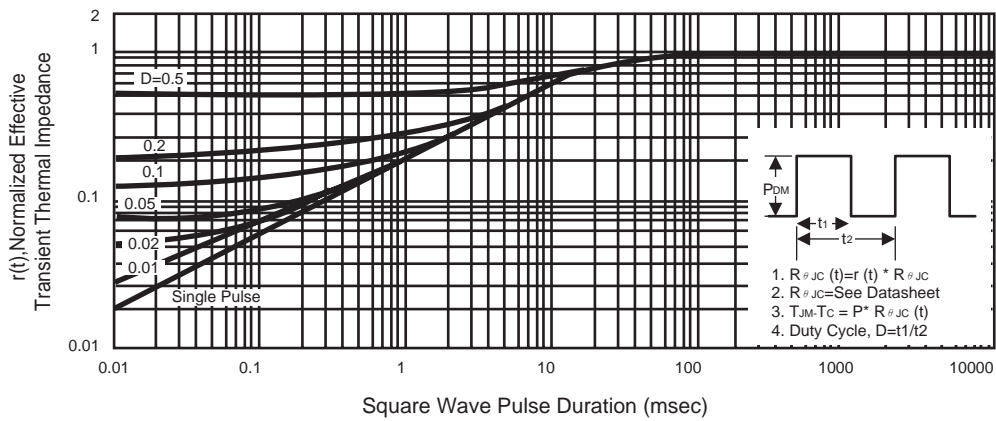

Figure 13. Normalized Thermal Transient Impedance Curve