



CEP70N06/CEB70N06

N-Channel Enhancement Mode Field Effect Transistor

FEATURES

- 60V, 70A, $R_{DS(ON)} = 13m\Omega$ @ $V_{GS} = 10V$.
- Super high dense cell design for extremely low $R_{DS(ON)}$.
- High power and current handling capability.
- Lead free product is acquired.
- TO-220 & TO-263 package.

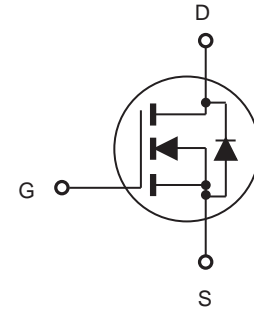

ABSOLUTE MAXIMUM RATINGS $T_C = 25^\circ C$ unless otherwise noted

Parameter	Symbol	Limit	Units
Drain-Source Voltage	V_{DS}	60	V
Gate-Source Voltage	V_{GS}	± 20	V
Drain Current-Continuous	I_D	70	A
Drain Current-Pulsed ^a	I_{DM}	280	A
Maximum Power Dissipation @ $T_C = 25^\circ C$ - Derate above $25^\circ C$	P_D	150	W
		1.0	W/ $^\circ C$
Single Pulsed Avalanche Energy ^d	E_{AS}	480	mJ
Single Pulsed Avalanche Current ^d	I_{AS}	50	A
Operating and Store Temperature Range	T_J, T_{stg}	-55 to 175	$^\circ C$

Thermal Characteristics

Parameter	Symbol	Limit	Units
Thermal Resistance, Junction-to-Case	$R_{\theta JC}$	1.0	$^\circ C/W$
Thermal Resistance, Junction-to-Ambient	$R_{\theta JA}$	62.5	$^\circ C/W$



CEP70N06/CEB70N06

Electrical Characteristics $T_C = 25^\circ\text{C}$ unless otherwise noted

4

Parameter	Symbol	Test Condition	Min	Typ	Max	Units
Off Characteristics						
Drain-Source Breakdown Voltage	BV_{DSS}	$V_{GS} = 0V, I_D = 250\mu A$	60			V
Zero Gate Voltage Drain Current	I_{DSS}	$V_{DS} = 58V, V_{GS} = 0V$			25	μA
Gate Body Leakage Current, Forward	I_{GSSF}	$V_{GS} = 20V, V_{DS} = 0V$			100	nA
Gate Body Leakage Current, Reverse	I_{GSSR}	$V_{GS} = -20V, V_{DS} = 0V$			-100	nA
On Characteristics^b						
Gate Threshold Voltage	$V_{GS(th)}$	$V_{GS} = V_{DS}, I_D = 250\mu A$	2		4	V
Static Drain-Source On-Resistance	$R_{DS(on)}$	$V_{GS} = 10V, I_D = 50A$		10	13	m Ω
Forward Transconductance	g_{FS}	$V_{DS} = 25V, I_D = 50A$		20.7		S
Dynamic Characteristics^c						
Input Capacitance	C_{iss}	$V_{DS} = 25V, V_{GS} = 0V, f = 1.0\text{ MHz}$		2384		pF
Output Capacitance	C_{oss}			567		pF
Reverse Transfer Capacitance	C_{rss}			69		pF
Switching Characteristics^c						
Turn-On Delay Time	$t_{d(on)}$	$V_{DD} = 30V, I_D = 50A, V_{GS} = 10V, R_{GEN} = 3.6\Omega$		19.3	38	ns
Turn-On Rise Time	t_r			9.7	19	ns
Turn-Off Delay Time	$t_{d(off)}$			41.8	63	ns
Turn-Off Fall Time	t_f			8.4	17	ns
Total Gate Charge	Q_g	$V_{DS} = 48V, I_D = 50A, V_{GS} = 10V$		50.7	66	nC
Gate-Source Charge	Q_{gs}			10.7		nC
Gate-Drain Charge	Q_{gd}			19.1		nC
Drain-Source Diode Characteristics and Maximum Ratings						
Drain-Source Diode Forward Current	I_S				50	A
Drain-Source Diode Forward Voltage ^b	V_{SD}	$V_{GS} = 0V, I_S = 50A$			1.3	V
Notes : a.Repetitive Rating : Pulse width limited by maximum junction temperature b.Pulse Test : Pulse Width $\leq 300\mu s$, Duty Cycle $\leq 2\%$. c.Guaranteed by design, not subject to production testing. d.L = 260 μH , $I_{AS} = 50A$, $V_{DD} = 24V$, $R_G = 25\Omega$, Starting $T_J = 25^\circ\text{C}$						



CEP70N06/CEB70N06

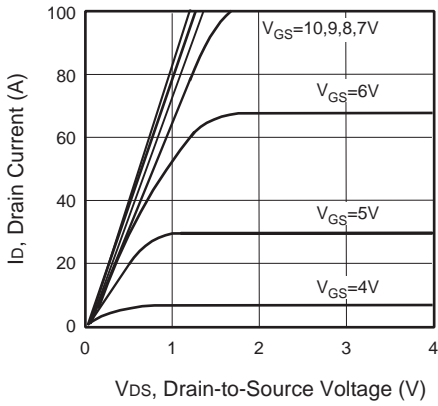

Figure 1. Output Characteristics

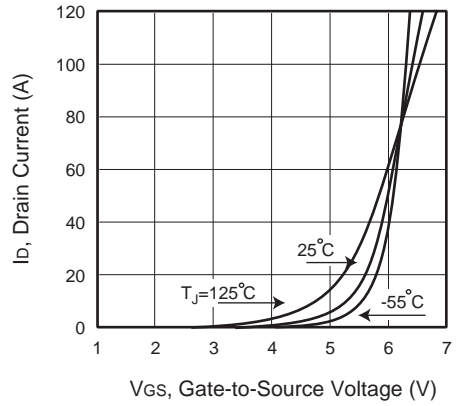

Figure 2. Transfer Characteristics

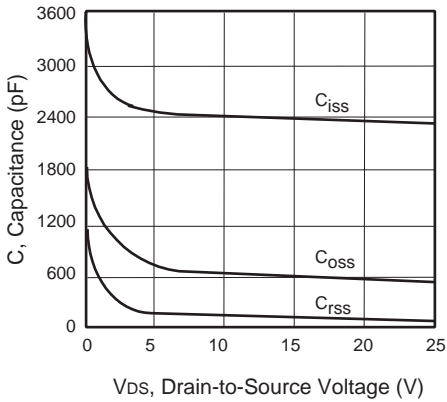

Figure 3. Capacitance

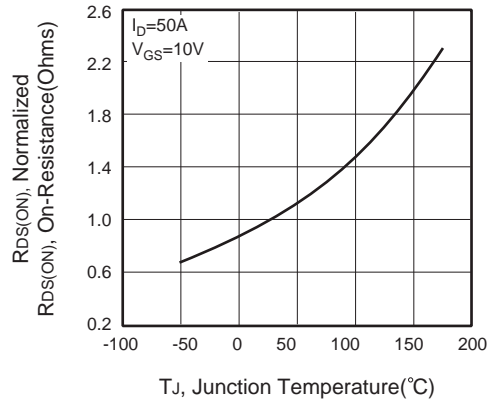

Figure 4. On-Resistance Variation with Temperature

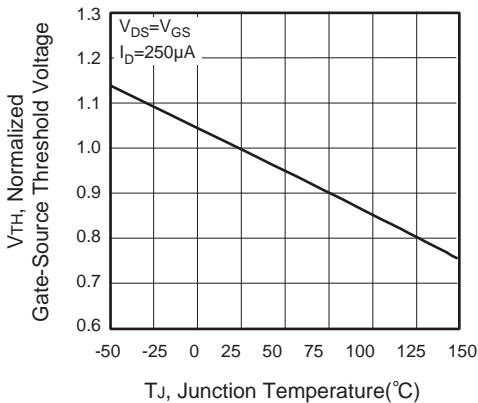

Figure 5. Gate Threshold Variation with Temperature

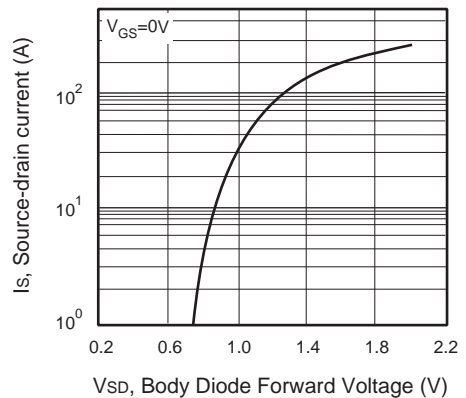

Figure 6. Body Diode Forward Voltage Variation with Source Current



CEP70N06/CEB70N06

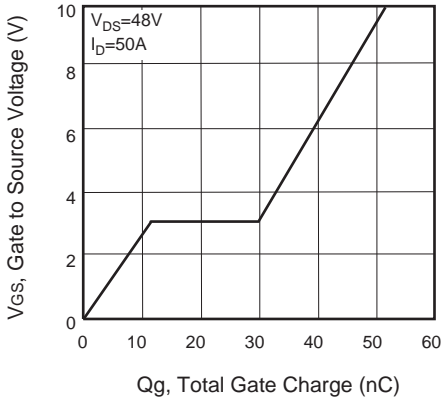

Figure 7. Gate Charge

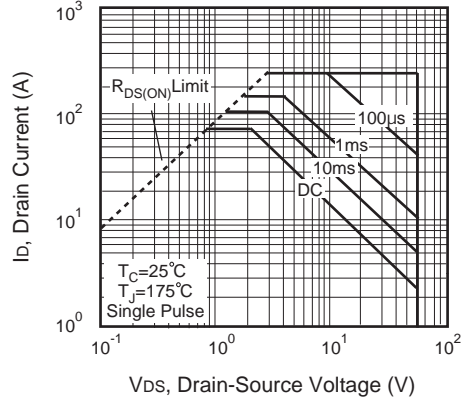

Figure 8. Maximum Safe Operating Area

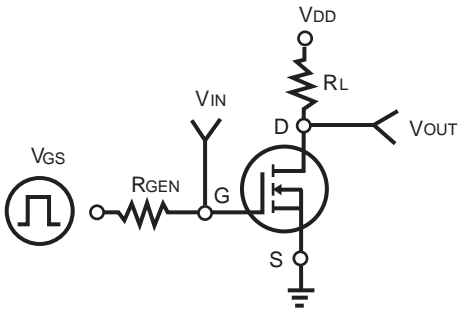

Figure 9. Switching Test Circuit

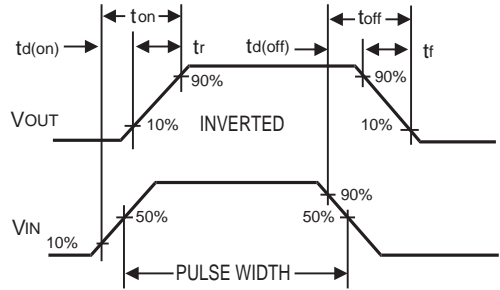

Figure 10. Switching Waveforms

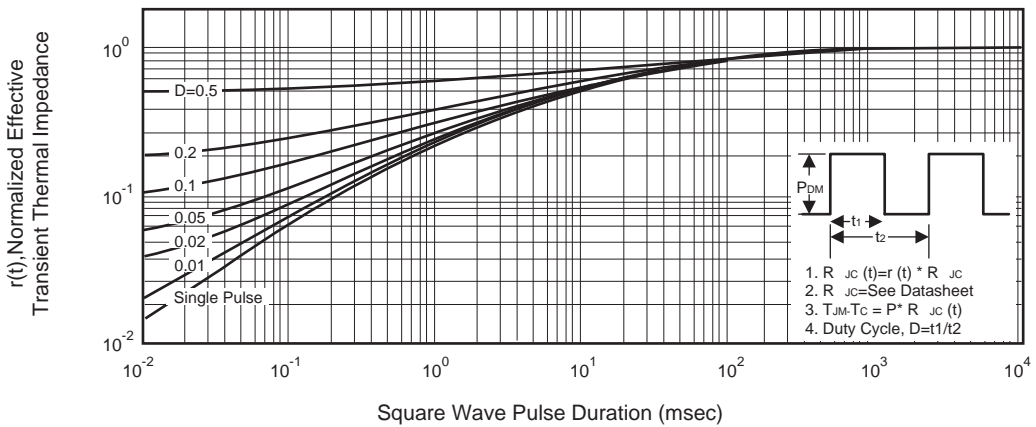

Figure 11. Normalized Thermal Transient Impedance Curve