



# CED01N65/CEU01N65

## N-Channel Enhancement Mode Field Effect Transistor

PRELIMINARY

### FEATURES

- 650V, 1.2A,  $R_{DS(ON)} = 10.5\Omega$  @  $V_{GS} = 10V$ .
- Super high dense cell design for extremely low  $R_{DS(ON)}$ .
- High power and current handling capability.
- Lead free product is acquired.
- TO-251 & TO-252 package.

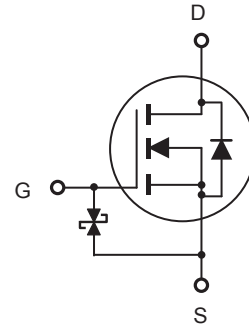

### ABSOLUTE MAXIMUM RATINGS $T_C = 25^\circ\text{C}$ unless otherwise noted

Parameter	Symbol	Limit	Units
Drain-Source Voltage	$V_{DS}$	650	V
Gate-Source Voltage	$V_{GS}$	$\pm 30$	V
Drain Current-Continuous	$I_D$	1.2	A
Drain Current-Pulsed <sup>a</sup>	$I_{DM}$	4.8	A
Maximum Power Dissipation @ $T_C = 25^\circ\text{C}$ - Derate above $25^\circ\text{C}$	$P_D$	35.7	W
		0.29	W/ $^\circ\text{C}$
Operating and Store Temperature Range	$T_J, T_{stg}$	-55 to 150	$^\circ\text{C}$

### Thermal Characteristics

Parameter	Symbol	Limit	Units
Thermal Resistance, Junction-to-Case	$R_{\theta JC}$	3.5	$^\circ\text{C/W}$
Thermal Resistance, Junction-to-Ambient	$R_{\theta JA}$	50	$^\circ\text{C/W}$

www.DataSheet4U.com

This is preliminary information on a new product in development now .  
Details are subject to change without notice .

Rev 1. 2007.Feb  
<http://www.cetsemi.com>



# CED01N65/CEU01N65

## Electrical Characteristics $T_C = 25^\circ\text{C}$ unless otherwise noted

Parameter	Symbol	Test Condition	Min	Typ	Max	Units
<b>Off Characteristics</b>						
Drain-Source Breakdown Voltage	$BV_{DSS}$	$V_{GS} = 0V, I_D = 250\mu A$	650			V
Zero Gate Voltage Drain Current	$I_{DSS}$	$V_{DS} = 650V, V_{GS} = 0V$			25	$\mu A$
Gate Body Leakage Current, Forward	$I_{GSSF}$	$V_{GS} = 30V, V_{DS} = 0V$			10	$\mu A$
Gate Body Leakage Current, Reverse	$I_{GSSR}$	$V_{GS} = -30V, V_{DS} = 0V$			-10	$\mu A$
<b>On Characteristics<sup>b</sup></b>						
Gate Threshold Voltage	$V_{GS(th)}$	$V_{GS} = V_{DS}, I_D = 250\mu A$	2.5		4.5	V
Static Drain-Source On-Resistance	$R_{DS(on)}$	$V_{GS} = 10V, I_D = 0.6A$		8.5	10.5	$\Omega$
<b>Dynamic Characteristics<sup>c</sup></b>						
Forward Transconductance	$g_{FS}$	$V_{DS} = 10V, I_D = 0.6A$		1		S
Input Capacitance	$C_{iss}$	$V_{DS} = 25V, V_{GS} = 0V, f = 1.0\text{ MHz}$		215		pF
Output Capacitance	$C_{oss}$			50		pF
Reverse Transfer Capacitance	$C_{rss}$			20		pF
<b>Switching Characteristics<sup>c</sup></b>						
Turn-On Delay Time	$t_{d(on)}$	$V_{DD} = 300V, I_D = 1.2A, V_{GS} = 10V, R_{GEN} = 4.7\Omega$		14.3	38.6	ns
Turn-On Rise Time	$t_r$			14.6	29.2	ns
Turn-Off Delay Time	$t_{d(off)}$			23	46	ns
Turn-Off Fall Time	$t_f$			17	34	ns
Total Gate Charge	$Q_g$	$V_{DS} = 480V, I_D = 1.2A, V_{GS} = 10V$		5.8	11.6	nC
Gate-Source Charge	$Q_{gs}$			1.9		nC
Gate-Drain Charge	$Q_{gd}$			2.4		nC
<b>Drain-Source Diode Characteristics and Maximum Ratings</b>						
Drain-Source Diode Forward Current	$I_S$				1.2	A
Drain-Source Diode Forward Voltage <sup>b</sup>	$V_{SD}$	$V_{GS} = 0V, I_S = 0.6A$			1.5	V
<b>Notes :</b> <input type="checkbox"/> a.Repetitive Rating : Pulse width limited by maximum junction temperature. <input type="checkbox"/> b.Device Mounted on FR4 Board, $t < 10\text{ sec.}$ <input type="checkbox"/> c.Pulse Test : Pulse Width $\leq 300\mu s$ , Duty Cycle $\leq 2\%$ . <input type="checkbox"/> d.Guaranteed by design, not subject to production testing. <input type="checkbox"/> <input type="checkbox"/>						



# CED01N65/CEU01N65

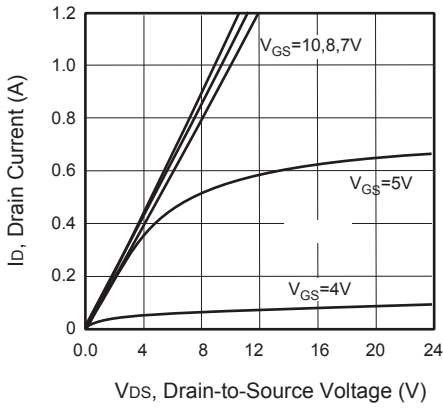

**Figure 1. Output Characteristics**

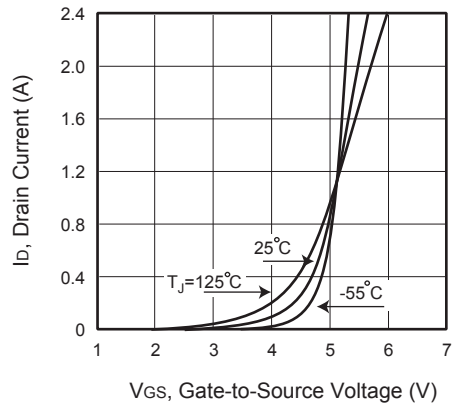

**Figure 2. Transfer Characteristics**

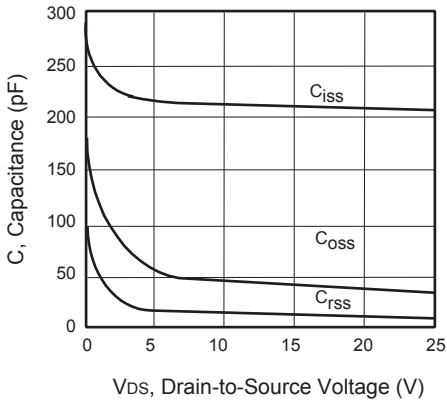

**Figure 3. Capacitance**

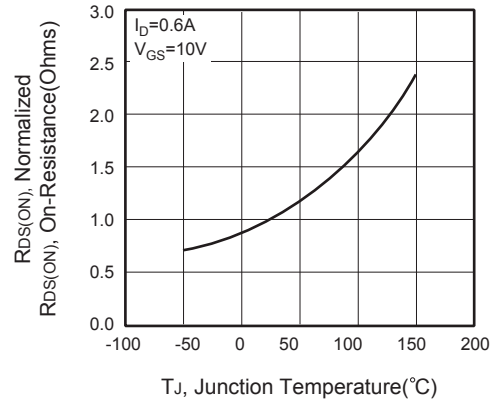

**Figure 4. On-Resistance Variation with Temperature**

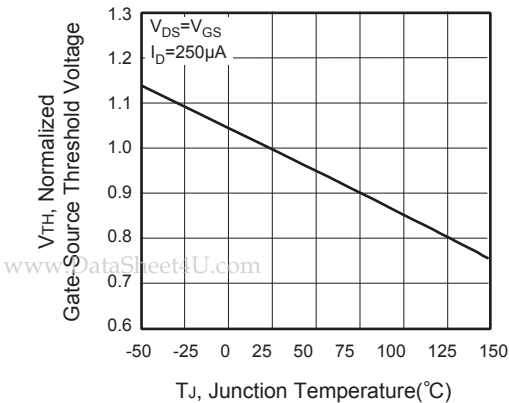

**Figure 5. Gate Threshold Variation with Temperature**

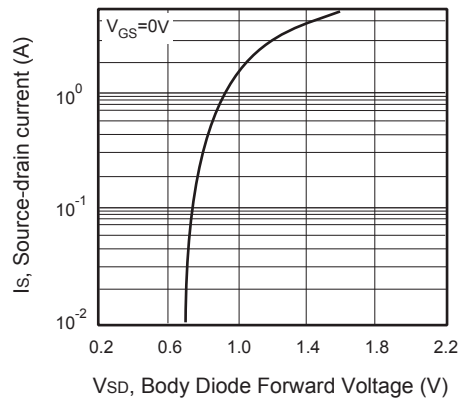

**Figure 6. Body Diode Forward Voltage Variation with Source Current**



# CED01N65/CEU01N65

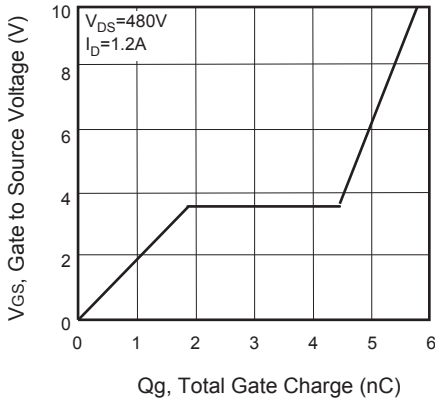

Figure 7. Gate Charge

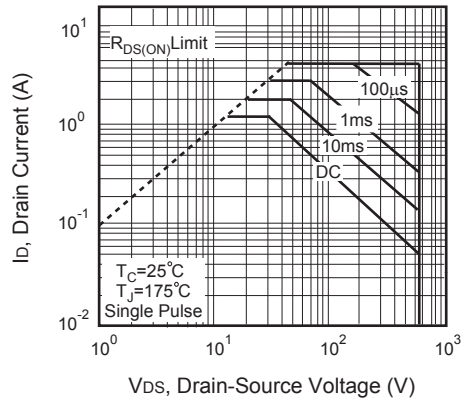

Figure 8. Maximum Safe Operating Area

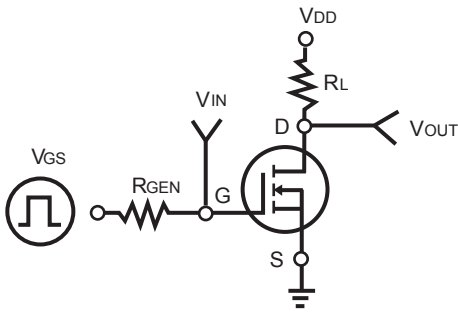

Figure 9. Switching Test Circuit

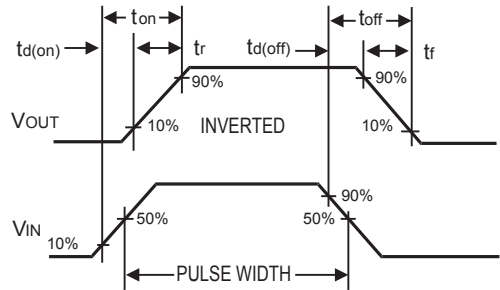

Figure 10. Switching Waveforms

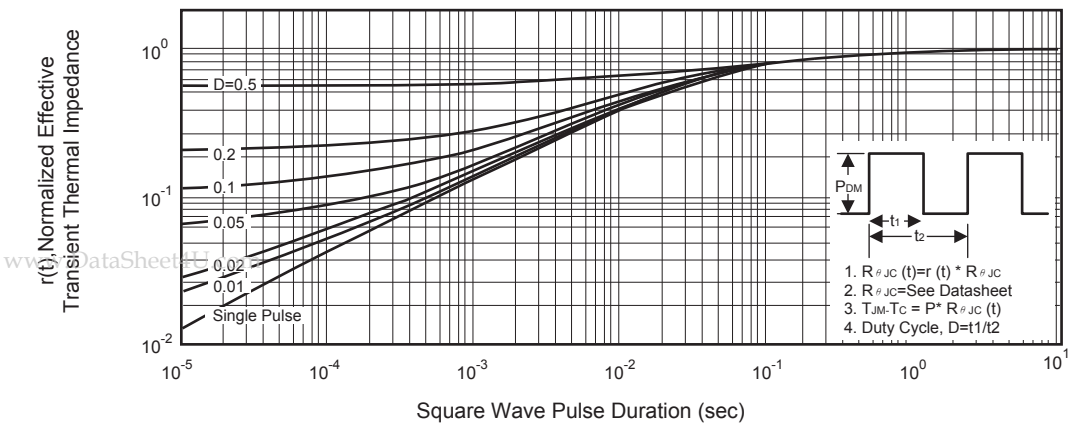

Figure 11. Normalized Thermal Transient Impedance Curve