

**SERIES:** CFM-92S | **DESCRIPTION:** DC AXIAL FAN**FEATURES**

- 92 x 92 mm frame
- multiple speed options for different cooling needs
- auto restart protection standard on all models
- 12 Vdc and 24 Vdc models available
- sleeve bearing construction



MODEL	input voltage		input current <sup>1</sup>	input power <sup>1</sup>	rated speed <sup>1</sup>	airflow <sup>2</sup>	static pressure <sup>3</sup>	noise <sup>4</sup>
	rated (Vdc)	range (Vdc)	max (A)	max (W)	typ (RPM±10%)	(CFM)	(inch H <sub>2</sub> O)	typ (dBA)
CFM-9232S-130-398	12	10.8~13.2	0.34	4.08	3,000	61.67	0.22	39.9
CFM-9238S-130-410	12	10.8~13.2	0.30	3.60	3,000	57.65	0.25	41.1
CFM-9232S-140-461	12	10.8~13.2	0.54	6.48	4,000	82.23	0.40	46.2
CFM-9238S-140-473	12	10.8~13.2	0.54	6.48	4,000	76.86	0.44	47.3
CFM-9238S-148-523	12	10.8~13.2	0.95	11.40	4,800	92.24	0.63	52.3
CFM-9232S-150-509	12	10.8~13.2	0.91	10.90	5,000	102.79	0.62	51.0
CFM-9232S-230-398	24	21.6~26.4	0.18	4.32	3,000	61.67	0.22	39.9
CFM-9238S-230-410	24	21.6~26.4	0.17	4.08	3,000	57.65	0.25	41.1
CFM-9232S-240-461	24	21.6~26.4	0.39	9.36	4,000	82.23	0.40	46.2
CFM-9238S-240-473	24	21.6~26.4	0.40	9.60	4,000	76.86	0.44	47.3
CFM-9238S-250-532	24	21.6~26.4	0.52	12.48	4,800	92.24	0.63	52.3
CFM-9232S-250-509	24	21.6~26.4	0.55	13.20	5,000	102.79	0.62	51.0

- Notes:
1. At rated voltage, after 3 minutes.
  2. At rated voltage, room temperature, 65% humidity, 0 inch H<sub>2</sub>O static pressure.
  3. At rated voltage, 0 CFM airflow.
  4. Measured in an anechoic chamber as per ISO3745/GB4214-84 at rated voltage, with background noise 20±2 dBA at 1 m from the fan intake.
  5. All specifications are measured at 25°C, 65% relative humidity unless otherwise specified.

## INPUT

parameter	conditions/description	min	typ	max	units
operating input voltage <sup>6</sup>	12 Vdc input models	10.8	12	13.2	Vdc
	24 Vdc input models	21.6	24	26.4	Vdc
starting voltage	12 Vdc input models		7.0		Vdc
	24 Vdc input models		14.0		Vdc

Note: 6. See Model section on page 1 for specific input voltage ranges.

## PERFORMANCE<sup>7</sup>

parameter	conditions/description	min	typ	max	units
rated speed	at rated voltage, 25°C, after 3 minutes	3,000		5,000	RPM
air flow	at 0 inch H <sub>2</sub> O, see performance curves	57.65		102.79	CFM
static pressure	at 0 CFM, see performance curves	0.22		0.63	inch H <sub>2</sub> O
noise	at 1 m, rated speed	39.9		52.3	dBa

Note: 7. See Model section on page 1 for specific values.

## PROTECTIONS / FEATURES

parameter	conditions/description	min	typ	max	units
auto restart	on all models				

## SAFETY & COMPLIANCE

parameter	conditions/description	min	typ	max	units
insulation resistance	at 500 Vdc between frame and positive terminal	10			MΩ
dielectric strength	at 500 Vac, 60 Hz, 1 minute between housing and positive terminal			5	mA
safety approvals	UL/cUL 507, TUV (EN 60950-1:2006+A11+A1+A12+A2)				
EMI/EMC	EN 55032:2015, EN 55024:2010+A1				
life expectancy	at 25°C, 65% RH, 90% confidence level		30,000		hours
RoHS	yes				

## ENVIRONMENTAL

parameter	conditions/description	min	typ	max	units
operating temperature		-10		70	°C
storage temperature		-40		75	°C
operating humidity	non-condensing	35		85	%
storage humidity	non-condensing	35		85	%

## PERFORMANCE CURVES

**CFM-9232S-130-398**

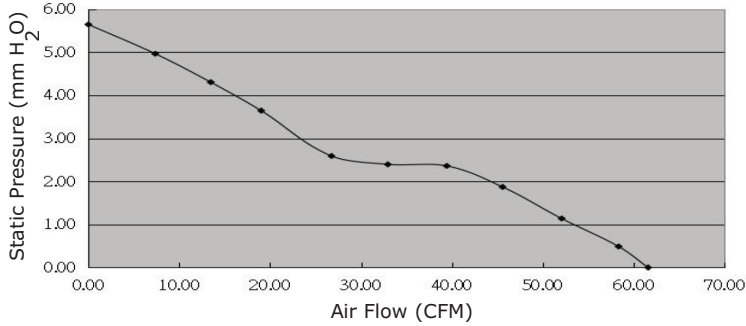

**CFM-9238S-130-410**

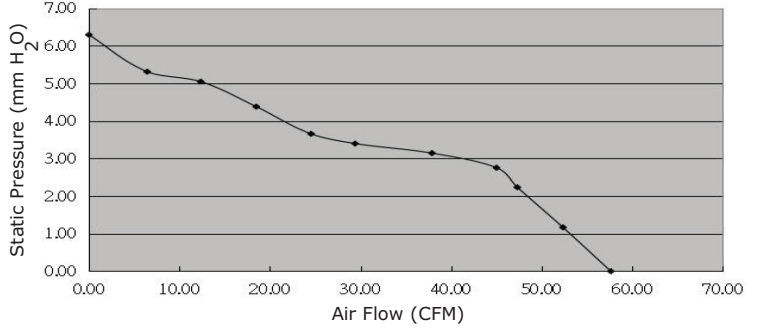

**CFM-9232S-140-461**

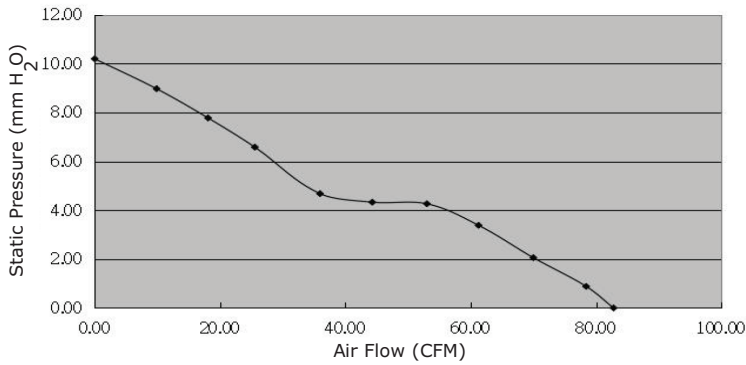

**CFM-9238S-140-473**

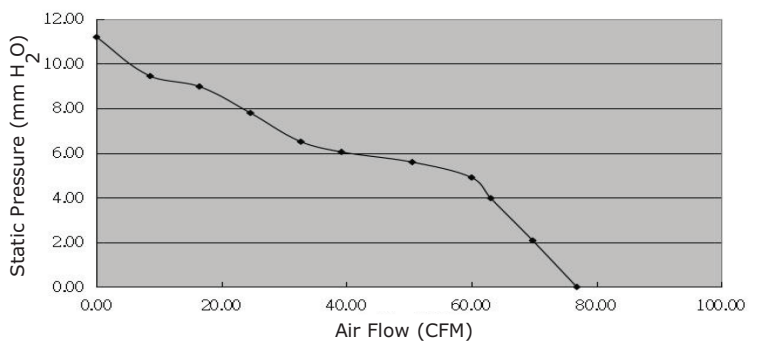

**CFM-9238S-148-523**

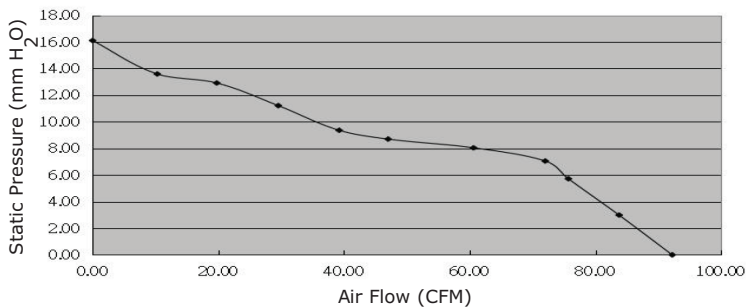

**CFM-9232S-150-509**

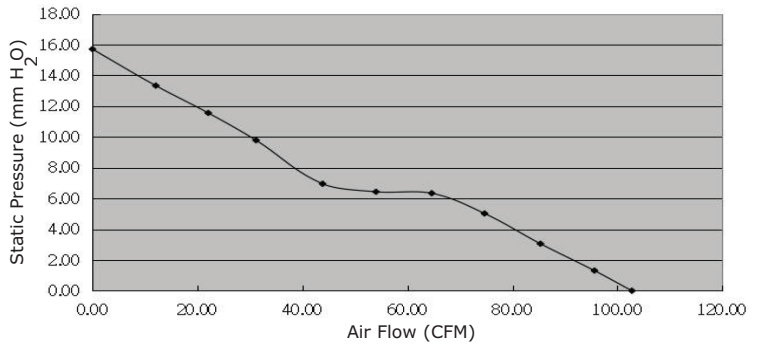

## PERFORMANCE CURVES

**CFM-9232S-230-398**

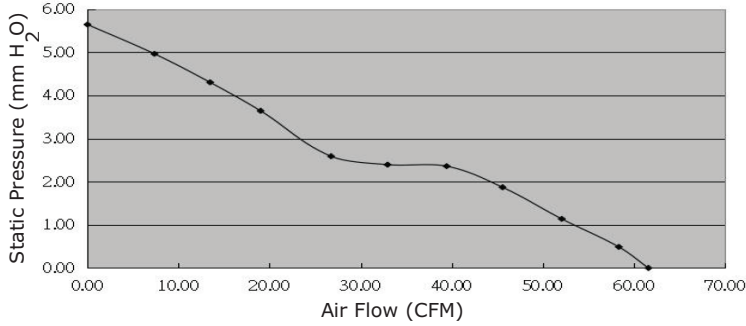

**CFM-9238S-230-410**

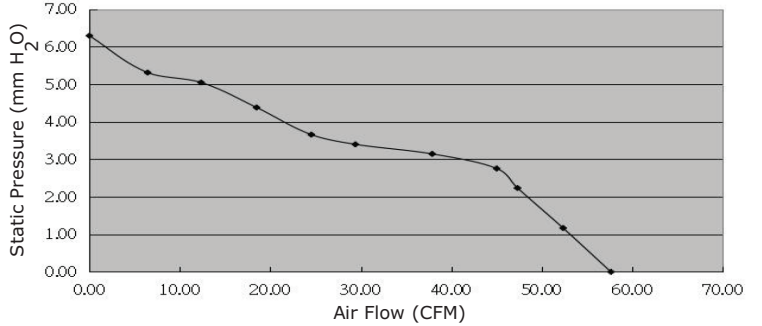

**CFM-9232S-240-461**

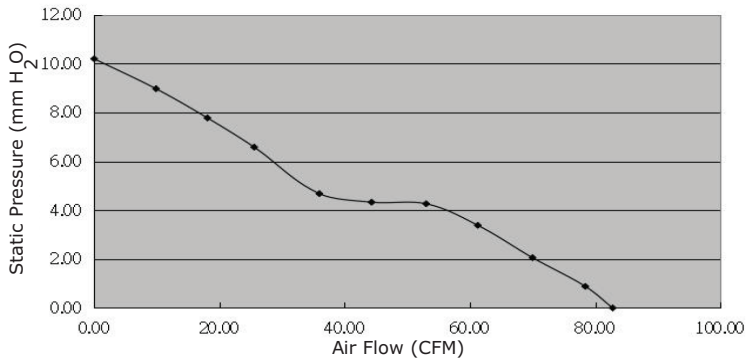

**CFM-9238S-240-473**

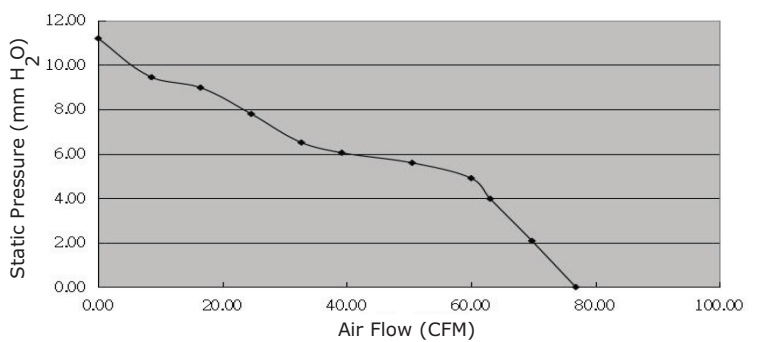

**CFM-9238S-250-532**

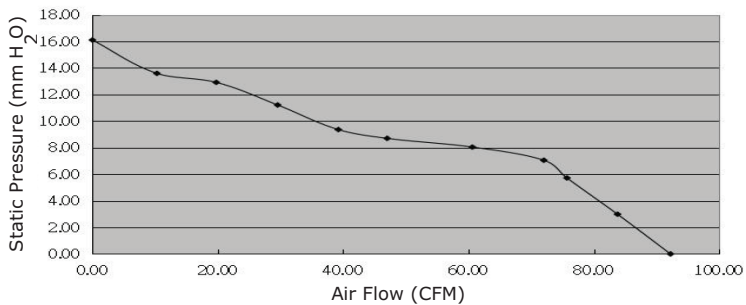

**CFM-9232S-250-509**

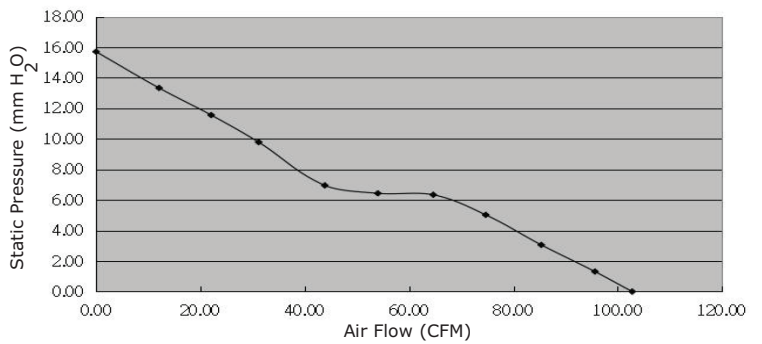

## MECHANICAL

parameter	conditions/description	min	typ	max	units
motor	4 pole DC brushless				
bearing system	sleeve bearing				
direction of rotation	counter-clockwise viewed from front of fan blade				
dimensions	CFM-9232S models: 92.2 x 92.2 x 32 CFM-9238S models: 92 x 92 x 37.5				mm mm
material	PBT (UL94V-0)				
weight	CFM-9232S models CFM-9238S models		181.2 200		g g

## MECHANICAL DRAWING

units: mm

wire: UL 1007, 24 AWG

MOUNTING SCREW (Pan Head)			
Screw Type	Size	Standard	Torque
Machine Screw	M4	JIS B1111-1974	5.5 kgf-cm
Self-tapping Screw	M5	JIS B1122 Type 2	5.5 kgf-cm

### CFM-9232S

WIRE CONNECTIONS	
Wire Color	Function
Red	+Vin
Black	-Vin

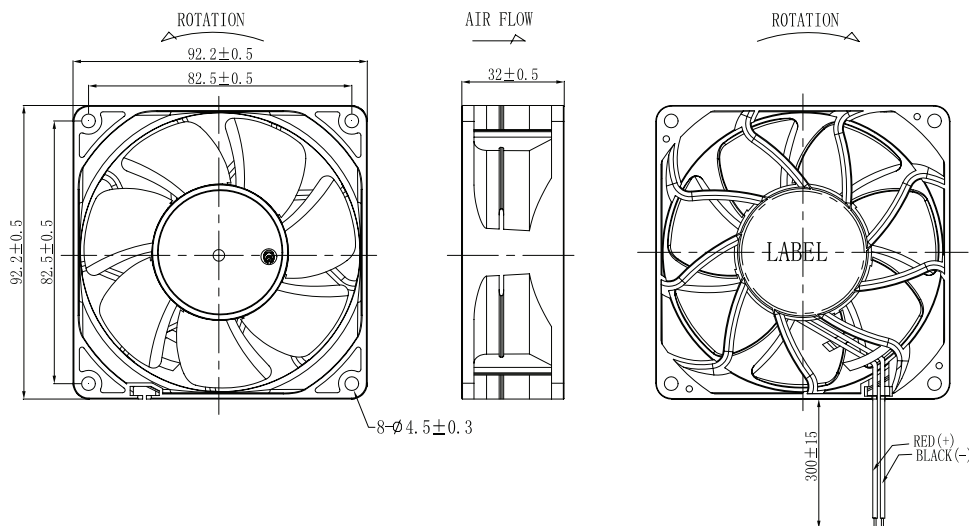

### CFM-9238S

WIRE CONNECTIONS	
Wire Color	Function
Red	+Vin
Black	-Vin

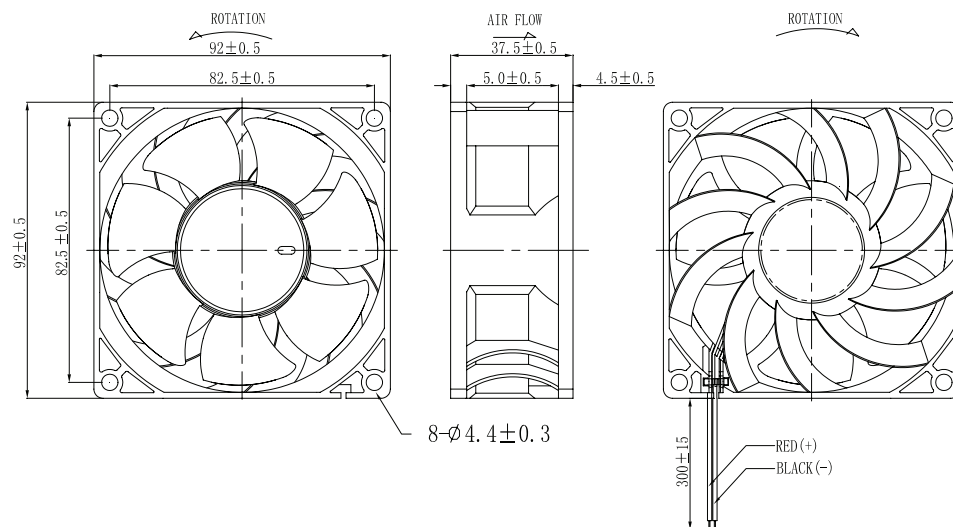

## REVISION HISTORY

---

rev.	description	date
1.0	initial release	04/14/2020

The revision history provided is for informational purposes only and is believed to be accurate.

---

# CUI DEVICES

CUI Devices offers a one (1) year limited warranty. Complete warranty information is listed on our website.

CUI Devices reserves the right to make changes to the product at any time without notice. Information provided by CUI Devices is believed to be accurate and reliable. However, no responsibility is assumed by CUI Devices for its use, nor for any infringements of patents or other rights of third parties which may result from its use.

CUI Devices products are not authorized or warranted for use as critical components in equipment that requires an extremely high level of reliability. A critical component is any component of a life support device or system whose failure to perform can be reasonably expected to cause the failure of the life support device or system, or to affect its safety or effectiveness.