



## Product Description

RFMD's CGA-1518Z is a high performance InGaP HBT MMIC Amplifier. Designed with InGaP process technology for excellent reliability. A Darlington configuration is utilized for broadband performance. The heterojunction increases breakdown voltage and minimizes leakage current between junctions. The CGA-1518Z contains two amplifiers for use in wideband push-pull CATV amplifiers requiring excellent second order performance. The second and third order non-linearities are greatly improved in the push-pull configuration.

### Optimum Technology Matching® Applied

- GaAs HBT
- GaAs MESFET
- InGaP HBT
- SiGe BiCMOS
- Si BiCMOS
- SiGe HBT
- GaAs pHEMT
- Si CMOS
- Si BJT
- GaN HEMT
- InP HBT
- RF MEMS
- LDMOS

## Amplifier Configuration

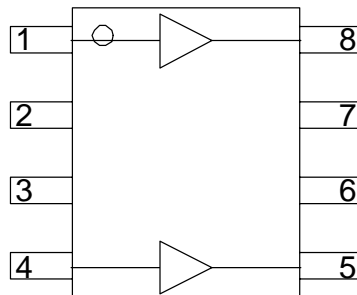

## Features

- 5V Single Supply
- Excellent Linearity Performance at +34dBmV Output Power Per Tone
- Two Amplifiers in Each SOIC-8 Package Simplify Push-Pull Configuration PC Board Layout
- Available in Lead-Free, RoHS Compliant, and Green Packaging
- SOIC-8 Package

## Applications

- CATV Head End Driver and Predriver Amplifier
- CATV Line Driver Amplifier

Parameter	Specification			Unit	Condition
	Min.	Typ.	Max.		
Small Signal Gain	14.9	15.5		dB	50MHz to 1000MHz
Gain Flatness		±0.6		dB	50Hz to 1000MHz
Output IP3		37		dBm	500MHz Tone Spacing=1MHz P <sub>OUT</sub> per Tone=+6dBm
Output Power at 1dB Gain Compression		20		dBm	500MHz
Input Return Loss		20		dB	500MHz
Output Return Loss		20		dB	500MHz
Noise Figure Balun Insertion Loss Included		4.5		dB	50MHz to 1000MHz
CSO		77		dBc	79 Ch., Flat Tilt, +34dBmV
CTB		70		dBc	79 Ch., Flat Tilt, +34dBmV
XMOD		61		dBc	79 Ch., Flat Tilt, +34dBmV
Device Operating Voltage		5.0		V	
Device Operating Current		150		mA	5V V <sub>CC</sub>
Thermal Resistance (Junction to Lead)		30		°C/W	Junction to case slug

Test Conditions: V<sub>CC</sub>=5V, I<sub>D</sub>=150mA Typ., T<sub>L</sub>=25°C, Z<sub>S</sub>=Z<sub>L</sub>=75Ω, Push Pull Application Circuit

## Absolute Maximum Ratings

Parameter	Rating	Unit
Max Device Current ( $I_D$ )	300	mA
Max Device Voltage ( $V_D$ )	6.0	V
Max RF Input Power	18	dBm
Max Junction Temp ( $T_J$ )	150	°C
Operating Temp Range ( $T_L$ )	-40 to +85	°C
Max Storage Temp	150	°C
Min Storage Temp	-40	°C

Operation of this device beyond any one of these limits may cause permanent damage. For reliable continuous operation, the device voltage and current must not exceed the maximum operating values specified in the table on page one.

Bias Conditions should also satisfy the following expression:

$$I_D V_D < (T_J - T_L) / R_{TH, j-l} \text{ and } T_L = T_{LEAD}$$



Caution! ESD sensitive device.

Exceeding any one or a combination of the Absolute Maximum Rating conditions may cause permanent damage to the device. Extended application of Absolute Maximum Rating conditions to the device may reduce device reliability. Specified typical performance or functional operation of the device under Absolute Maximum Rating conditions is not implied.

RoHS status based on EU Directive 2002/95/EC (at time of this document revision).

The information in this publication is believed to be accurate and reliable. However, no responsibility is assumed by RF Micro Devices, Inc. ("RFMD") for its use, nor for any infringement of patents, or other rights of third parties, resulting from its use. No license is granted by implication or otherwise under any patent or patent rights of RFMD. RFMD reserves the right to change component circuitry, recommended application circuitry and specifications at any time without prior notice.

Input Return Loss

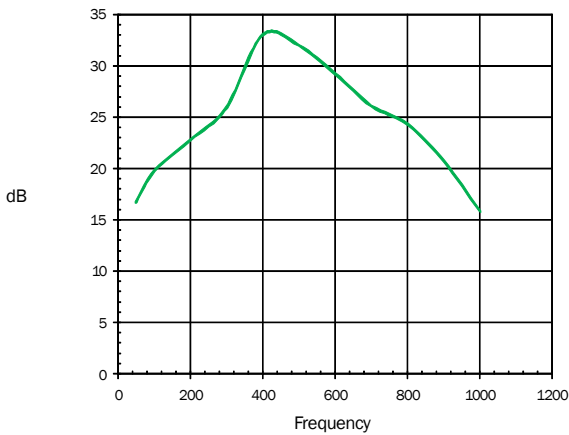

Output Return Loss

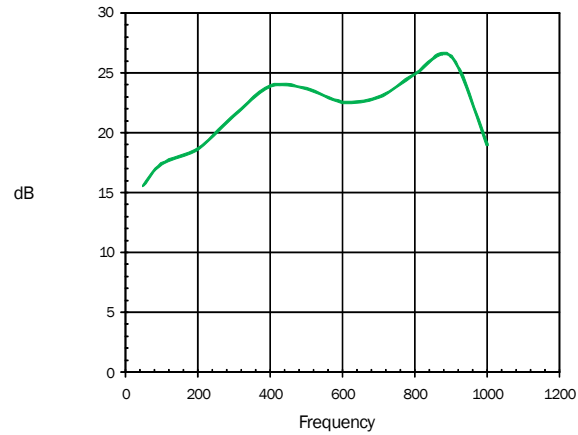

Gain

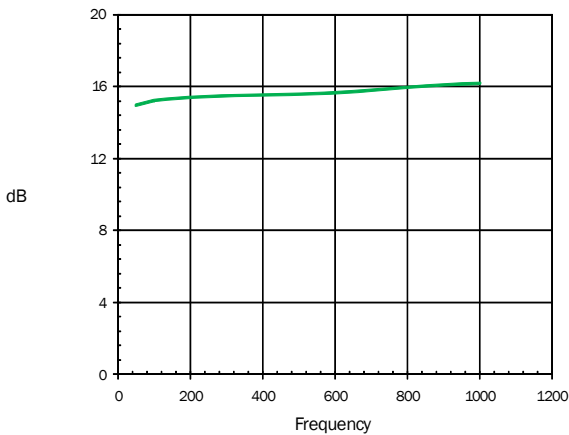

Reverse Isolation

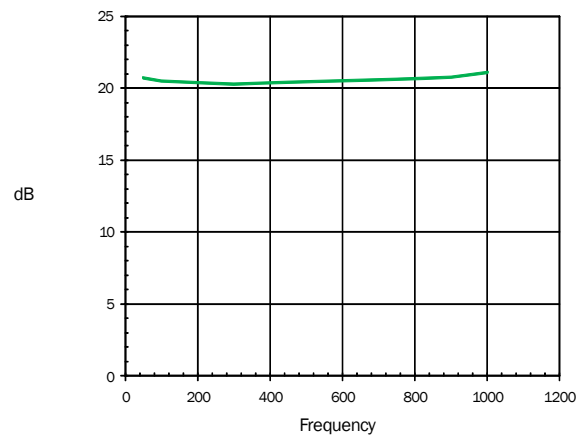

**Noise Figure**

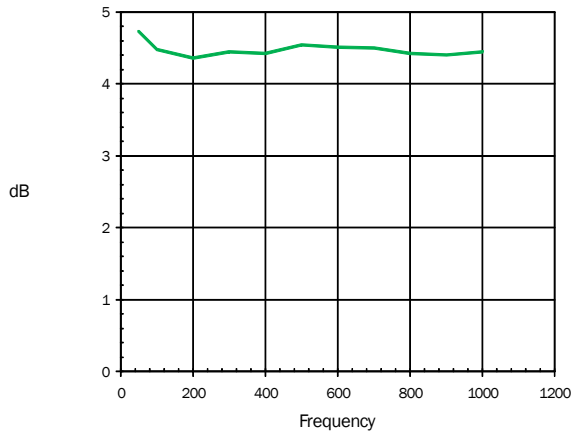

**Output P1dB**

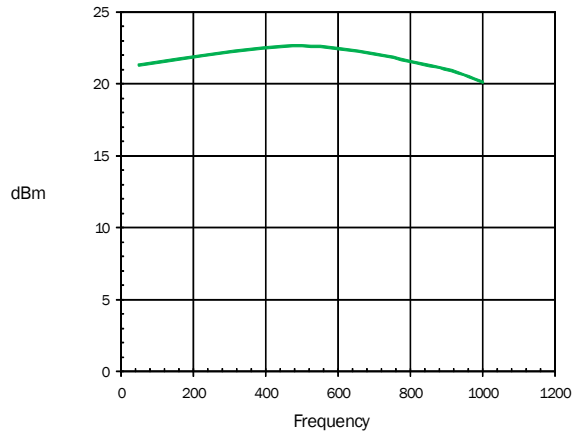

**Output IP3**

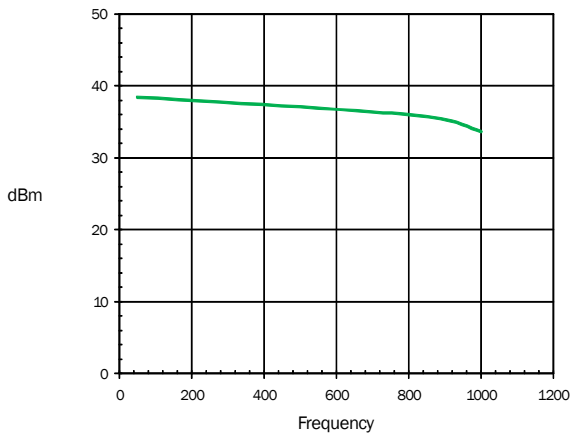

**XMOD**

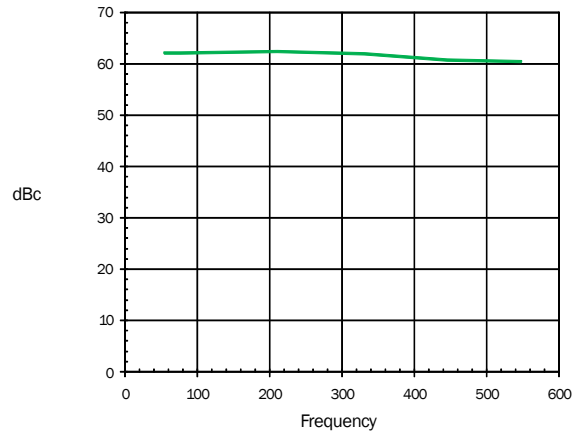

**CSO**

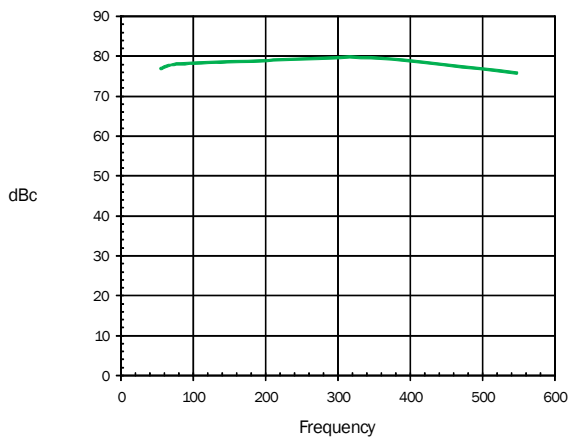

**CTB**

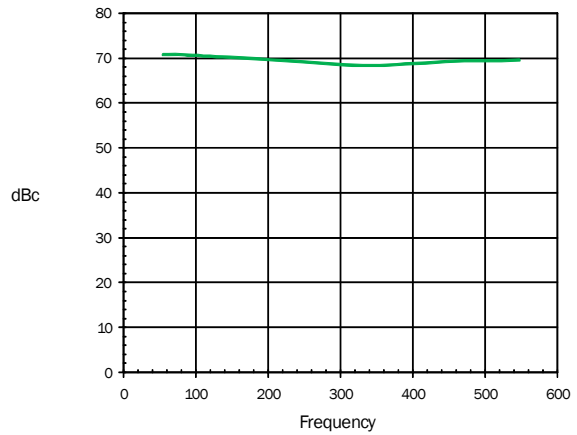

## 50 MHz to 1000 MHz Evaluation Board Schematic

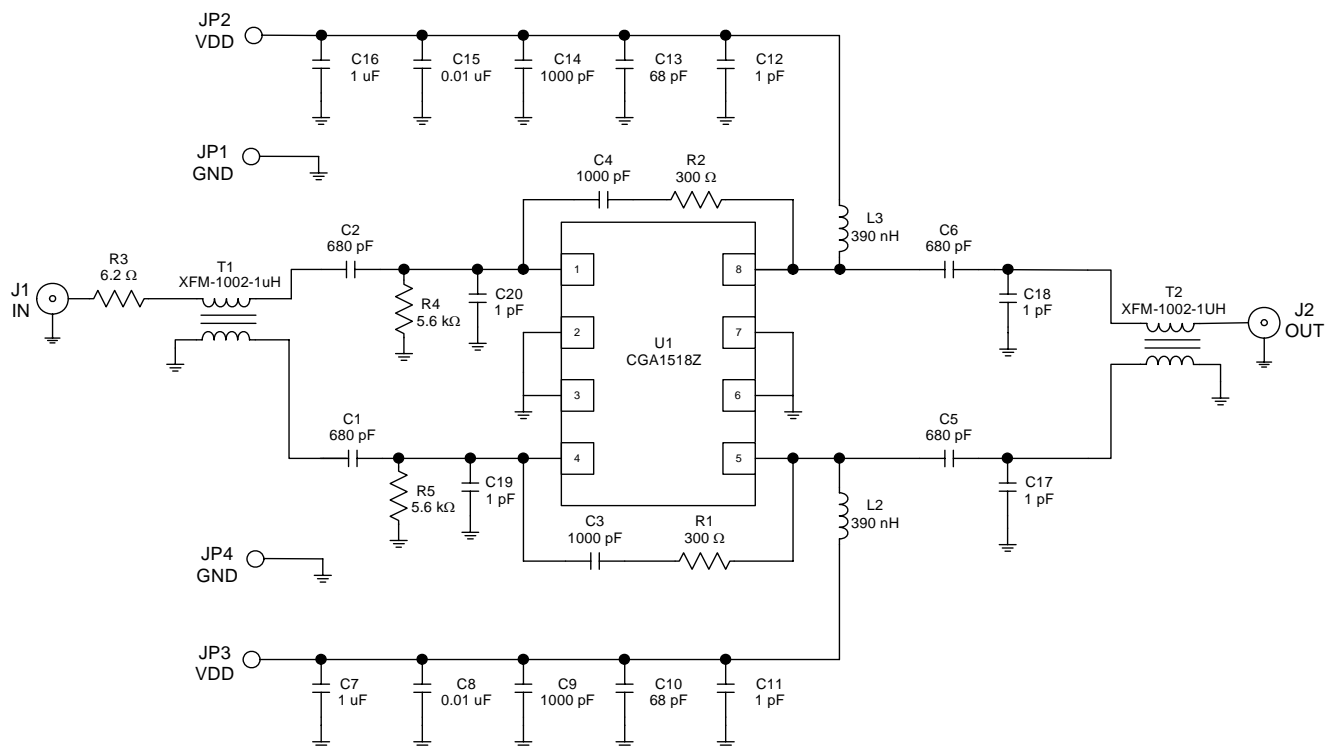

### Component Chart

Value	Qty	Location
RFMD™ CGA-1518Z	1	U1
1 pF	6	C11, C12, C17, C18, C19, C20
68 pF	2	C10, 13
680 pF	4	C1, C2, C5, C6
1000 pF	4	C3, C4, C9, C14
0.01 uF	2	C8, 15
1 uF	2	C7, C16
6.2Ω	1	R3
5.6kΩ	2	R4, R5
300Ω	2	R1, R2
390 nH	2	L2, L3
RFMD™ XFM-1002-1 uH	2	T1, T2

**50MHz to 1000MHz Evaluation Layout**

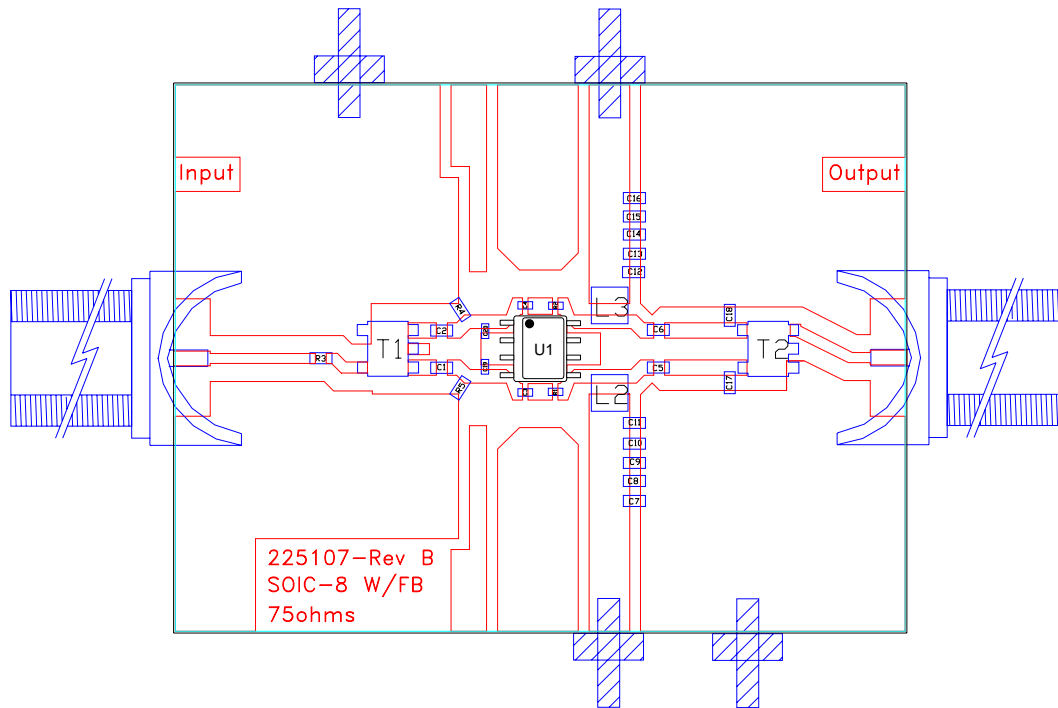

Pin	Function	Description
1	RF IN	RF input pin. External DC-blocking capacitor is required.
2, 3, 6, 7	GND	Connection to ground. Use via holes for best performance to reduce lead inductance as close to ground leads as possible.
4	RF IN	Same as pin 1.
5	RF OUT/VCC	RF output and bias pin (open collector).
8	RF OUT/VCC	Same as pin 5.
EPAD	GND	Exposed area on the bottom side of the package must be soldered to the ground plane of the board for optimum thermal and RF performance. Several vias should be located under the EPAD as shown in the recommended land pattern.

## Pin Out

### Amplifier Configuration

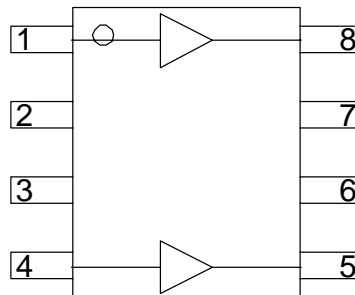

### Part Identification

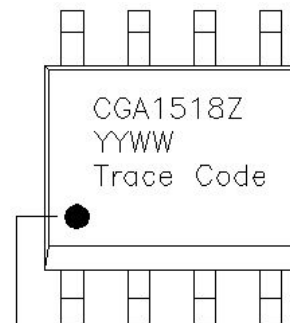

Pin 1 Indicator

### Suggested Pad Layout

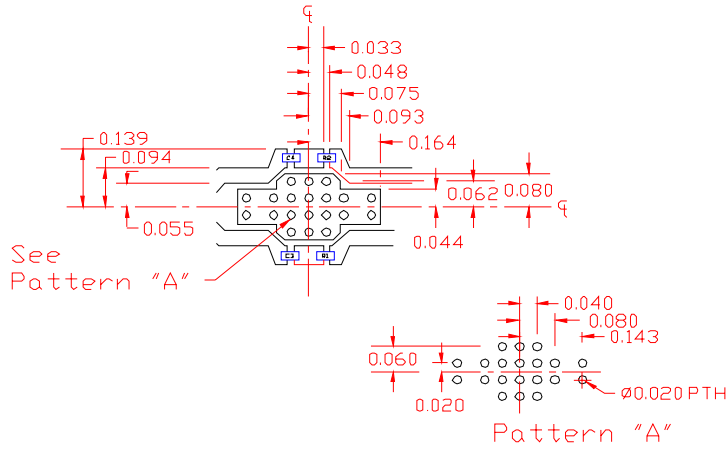

### Package Drawing and Marking

Dimensions in inches (millimeters)

Refer to drawing posted at [www.rfmd.com](http://www.rfmd.com) for tolerances.

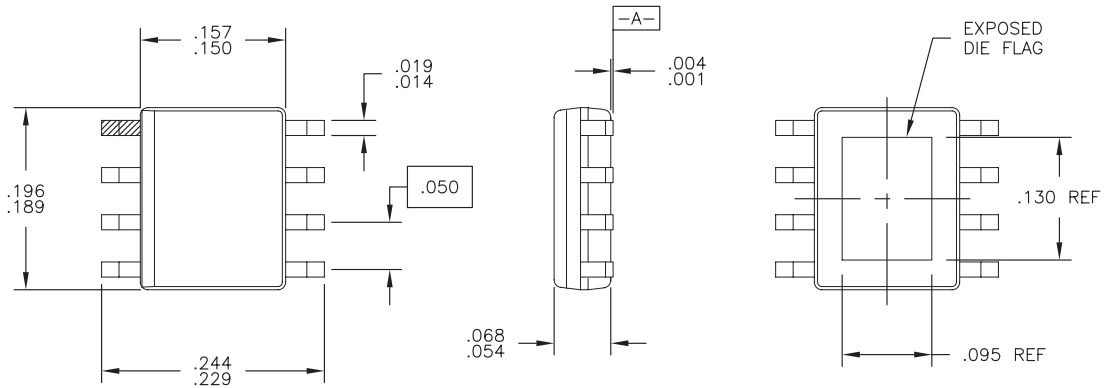

**NOTES:**

1. SHADED LEAD IS PIN 1.
2. LEAD COPLANARITY: .003 WITH RESPECT TO DATUM 'A'.
3. DIMENSIONS DO NOT INCLUDE MOLD FLASH OR PROTRUSIONS.

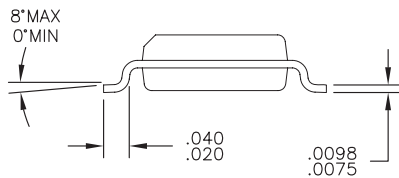

## Ordering Information

Part Number	Description	Reel Size	Devices/Reel
CGA1518ZSB	5pcs Sample Bag	NA	NA
CGA1518ZSQ	25pcs Sample Bag	NA	NA
CGA1518ZSR	Lead Free, RoHS Compliant	7	100
CGA1518ZTR7	Lead Free, RoHS Compliant	7	750
CGA1518ZTR13	Lead Free, RoHS Compliant	13	2500
CGA1518PCBA-410	50MHz to 1000MHz Evaluation Board	NA	NA