

Product Description

Sirenza Microdevices' CGB-1089Z is a high performance InGaP HBT MMIC amplifier utilizing a Darlington configuration with a 75 ohm active bias network. The active bias network provides stable current over temperature and process Beta variations. Designed to run directly from a 5V supply, the CGB-1089Z does not require a dropping resistor as compared to typical Darlington amplifiers. The CGB-1089Z product is designed for high linearity 5V gain block applications that require small size and minimal external components. It is internally matched to 75 ohms.

CGB-1089Z



50 - 1000 MHz Single Ended InGaP/GaAs HBT MMIC CATV Amplifier

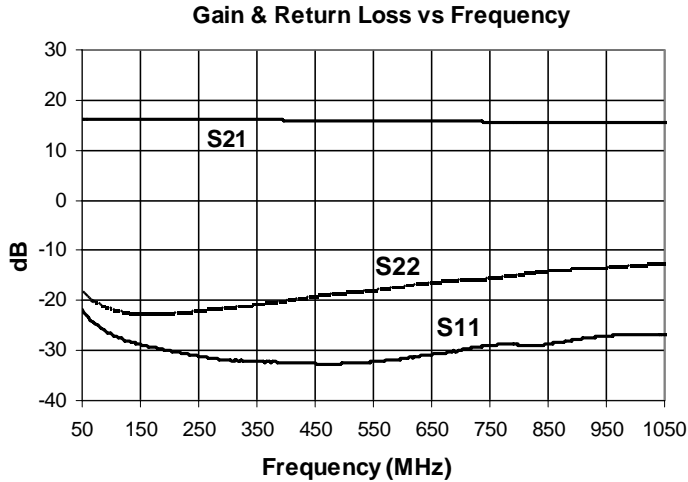

Product Features

- Flat Gain Response: 16dB +/- .4dB
- Excellent Return Loss: 21dB
- Low Distortion: -77/ -65dBc CTB/CSO
- Single Fixed 5V Supply
- Robust 1000V ESD, Class 1C

Applications

- CATV Network Amplifiers
- CATV Drop Amplifiers
- Optical Rx/Tx
- FTTH Video Solutions

www.uataShee4U.com

Symbol	Parameters	Units	Frequency	Min.	Typ.	Max.
S ₂₁	Small Signal Gain	dB	500 MHz	14.5	16	17.5
P _{1dB}	Output Power at 1dB Compression	dBm	500 MHz	16.5	18	
IP ₃	Third Order Intercept Point	dBm	500 MHz		35	
IP ₂	Second Order Intercept Point	dBm	500 MHz		50	
CSO	79Ch., Flat Tilt, 25 dBmV	dBc			-65	
CTB	79Ch., Flat Tilt, 25 dBmV	dBc			-77	
XMOD	79Ch., Flat Tilt, 25 dBmV	dBc			76	
IRL	Worst Case Input Return Loss	dB	50 -1000MHz	18	21	
ORL	Worst Case Output Return Loss	dB	50 -1000MHz	10	12.5	
S ₁₂	Reverse Isolation	dB	50 -1000MHz		19	
NF	Noise Figure	dB	500 MHz		3.5	4
V _D	Device Operating Voltage	V			5	
I _D	Device Operating Current	mA		68	80	92
R _{TH, j-l}	Thermal Resistance (junction - lead)	°C/W			48.8	

Test Conditions:

V_D = 5V

I_D = 80mA Typ.

OIP₃, OIP₂ Tone Spacing = 6MHz, Pout per tone = 0 dBm

T_L = 25°C

Z_S = Z_L = 75 Ohms

Tested with App Circuit

The information provided herein is believed to be reliable at press time. Sirenza Microdevices assumes no responsibility for inaccuracies or omissions. Sirenza Microdevices assumes no responsibility for the use of this information, and all such information shall be entirely at the user's own risk. Prices and specifications are subject to change without notice. No patent rights or licenses to any of the circuits described herein are implied or granted to any third party. Sirenza Microdevices does not authorize or warrant any Sirenza Microdevices product for use in life-support devices and/or systems. Copyright 2006 Sirenza Microdevices, Inc.. All worldwide rights reserved.

Typical RF Performance with Application Circuit (pg. 5) at Key Operating Frequencies

Symbol	Parameter	Unit	Frequency (MHz)					
			50	100	250	500	850	1000
S ₂₁	Small Signal Gain	dB	16.3	16.2	16.1	16	15.5	15.4
OIP ₃	Output Third Order Intercept Point	dBm	39.8	39.2	36.8	35	32.7	31.6
OIP ₂	Output Second Order Intercept Point	dBm	58.7	59.2	57.2	50	44	42.5
P _{1dB}	Output Power at 1dB Compression	dBm	18	18	18	18	17.5	17
S ₁₁	Input Return Loss	dB	21	28	32	32	26	24
S ₂₂	Output Return Loss	dB	19	21	22	18	13	12
S ₁₂	Reverse Isolation	dB	19	19	19	19	19	19
NF	Noise Figure	dB	3.5	3.4	3.6	3.5	3.6	3.6

Test Conditions: V_{CC} = 5V I_D = 80mA Typ. OIP₃, OIP₂ Tone Spacing = 6MHz, Pout per tone = 0 dBm
T_L = 25°C Z_S = Z_L = 75 Ohms

Absolute Maximum Ratings

Parameter	Absolute Limit
Max. Device Current (I _D)	110 mA
Max. Device Voltage (V _D)	5.5 V
Max. RF Input Power	+12 dBm
Max. Operating Dissipated Power	0.61 W
Max. Junction Temp. (T _J)	+150°C
Operating Temp. Range (T _L)	-40°C to +85°C
Max. Storage Temp.	+150°C

Operation of this device beyond any one of these limits may cause permanent damage. For reliable continuous operation, the device voltage and current must not exceed the maximum operating values specified in the table on page one.

Bias Conditions should also satisfy the following expression:

$$I_D V_D < (T_J - T_L) / R_{TH}, j-l \quad T_L = T_{LEAD}$$

Reliability & Qualification Information

Parameter	Rating
ESD Rating - Human Body Model (HBM)	Class 1C
Moisture Sensitivity Level	MSL 1

This product qualification report may be downloaded at www.sirenza.com



Appropriate precautions in handling, packaging and testing devices must be observed.

Typical Unit Performance. See page 5 for application circuit.

P1dB vs Frequency, Typ Unit vs Temp

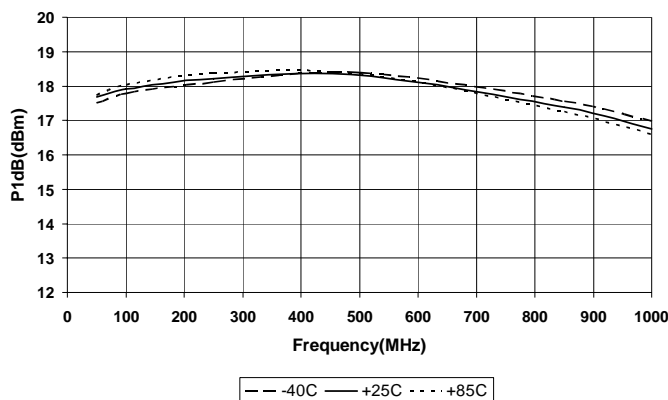

OIP3 Vs Freq. Typ. Unit Pout/Tone = 0dBm, 6MHz Spacing

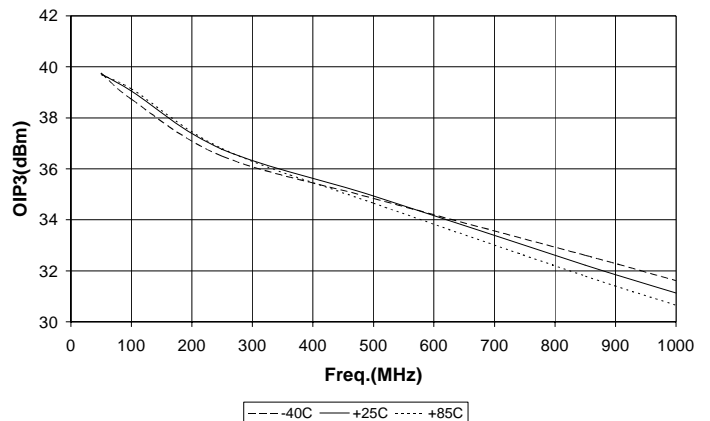

Typical Unit Performance. See page 5 for application circuit.

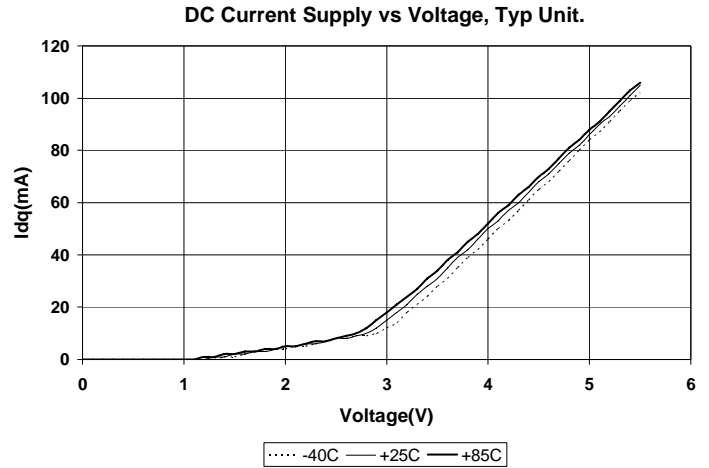
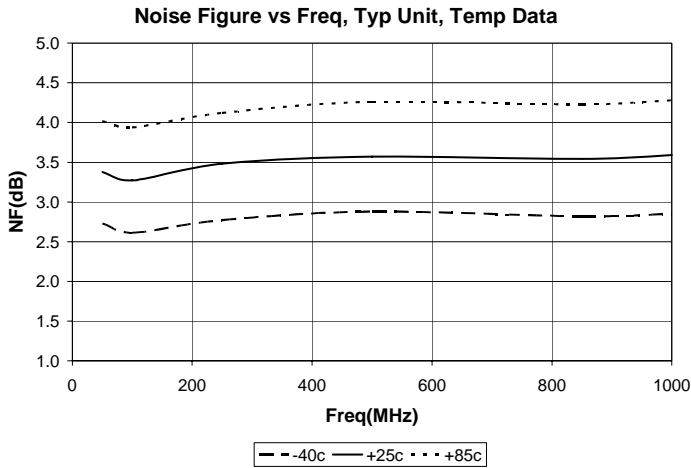

Typical Unit S-Parameters vs Temperature. See page 5 for application circuit.

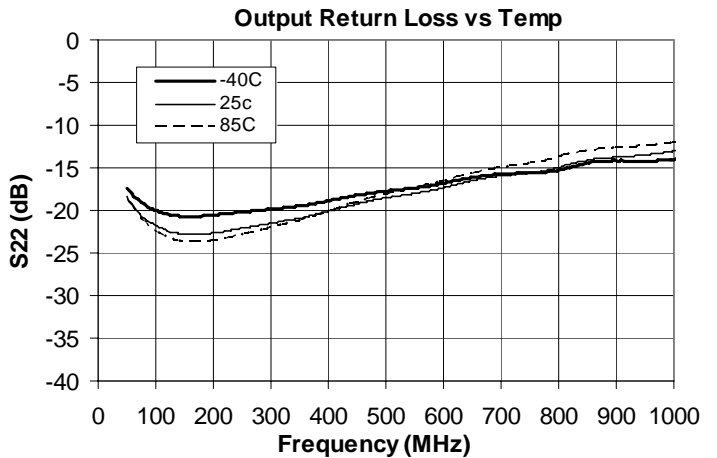
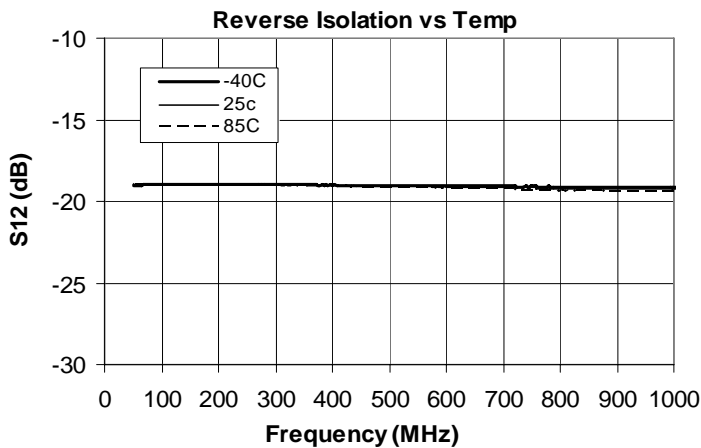
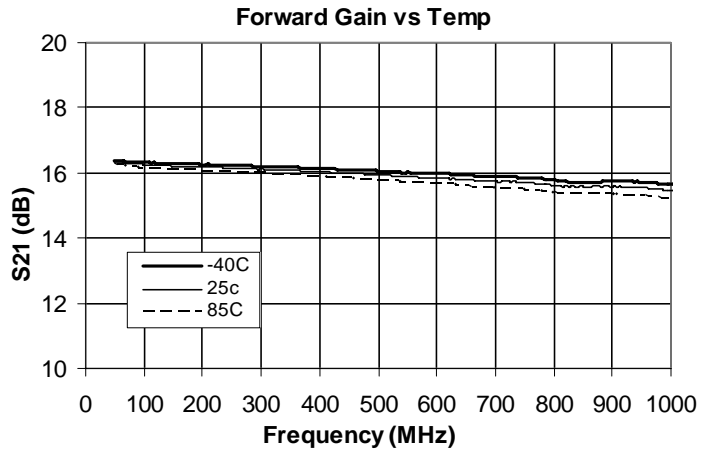
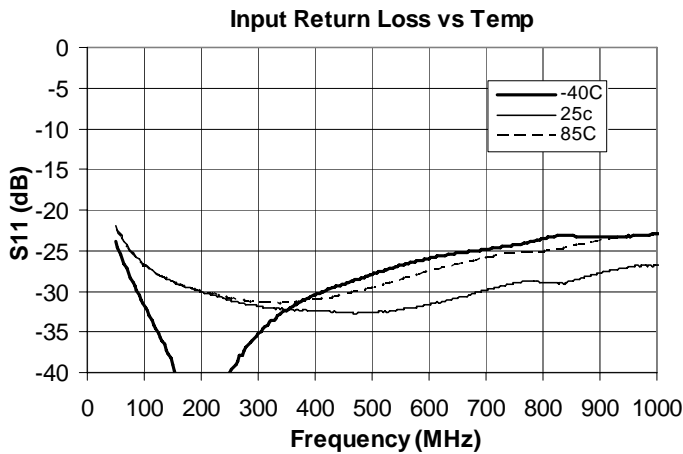

CSO/CTB/XMOD Typical Unit Performance. See page 5 for app circuit.

V_d=5V, I_d=80mA, T=+25c, 79 Channel Plan, +25dBmV Flat Tilt Output

Cross Modulation vs Frequency, Typ. Unit
+25dBmV Flat, 79Ch

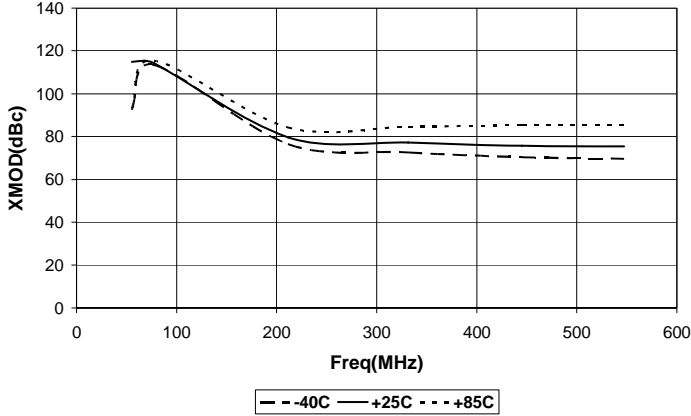

Composite Triple Beat vs Frequency
Typ Unit, +25dBmV Flat, 79Ch

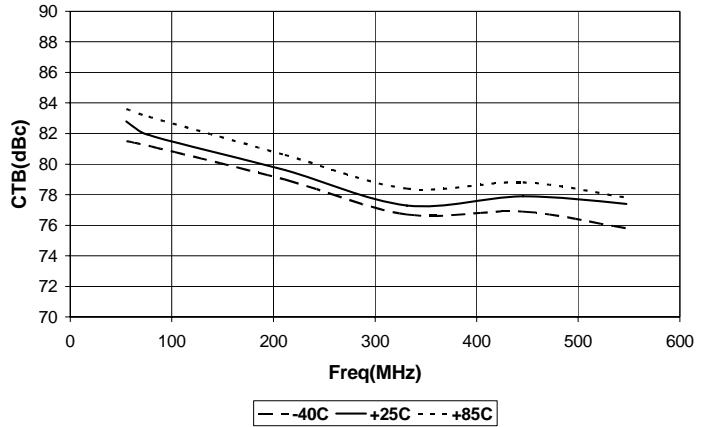

Composite Second Order(-) vs Frequency
+25dBmV Flat Output, 79Ch

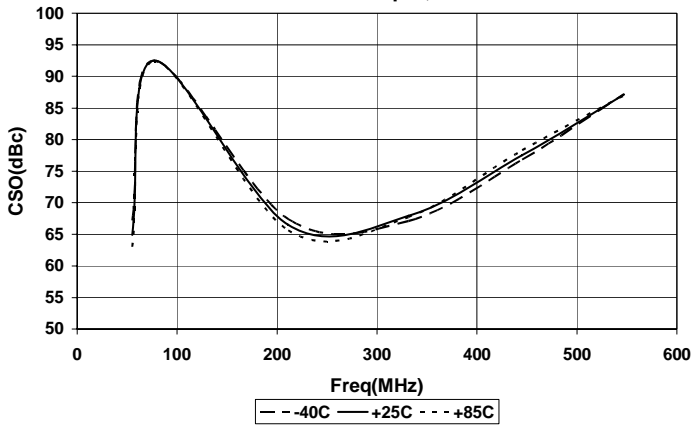

Composite Second Order(+) vs Frequency
+25dBmV Flat Output, 79Ch

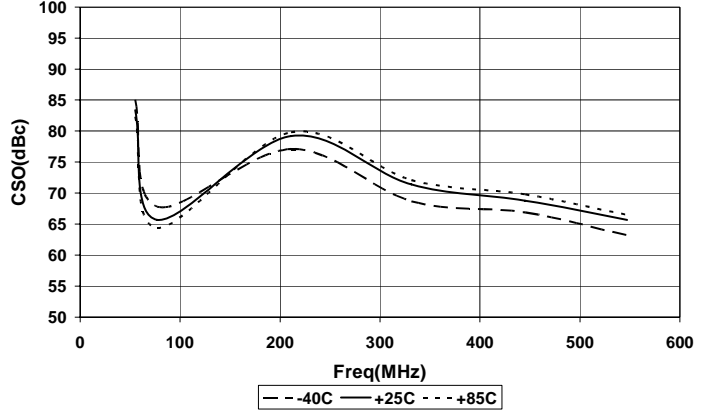

Application Schematic

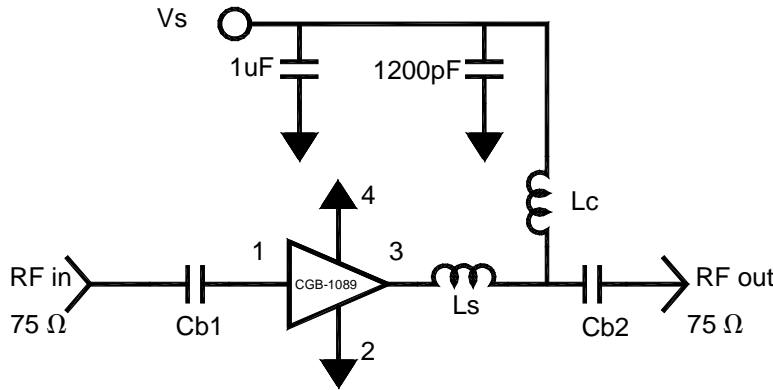

Application Circuit Element Values

Reference Designator	Frequency (MHz) 50 to 1000
C _{B1}	1200pF
C _{B2}	220pF
L _C	1.5uH LS Coilcraft
L _S	2.7nH Toko

Evaluation Board Layout

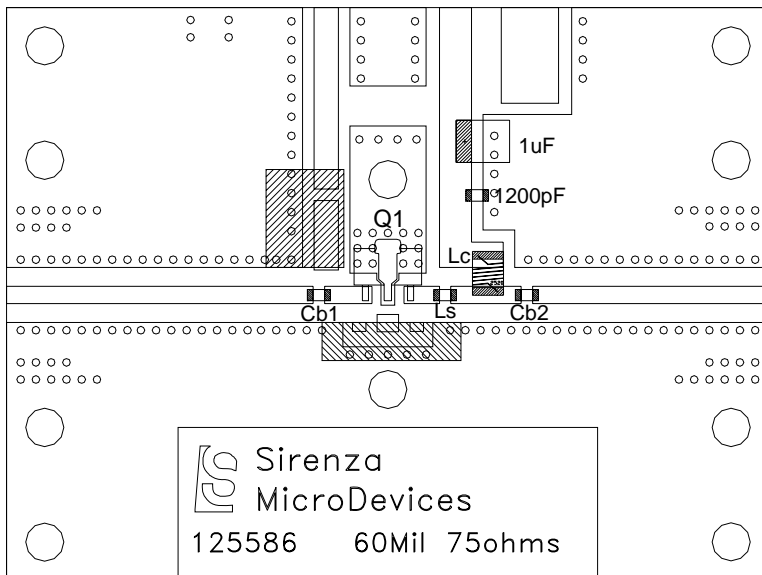

Mounting Instructions

1. Solder the copper pad on the backside of the device package to the ground plane.
2. Use a large ground pad area with many plated through-holes as shown.
3. We recommend 1 or 2 ounce copper. Measurement for this datasheet were made on a 60 mil thick GTEK board with 1 ounce copper on both sides.

Pin Description

Pin #	Function	Description
1	RF IN	RF input pin. This pin requires the use of an external DC blocking capacitor chosen for the frequency of operation.
2, 4	GND	Connection to ground. Use via holes for best performance to reduce lead inductance as close to ground leads as possible
3	RF OUT/ BIAS	RF output and bias pin. DC voltage is present on this pin, therefore a DC blocking capacitor is necessary for proper operation.

Part Number Ordering Information

Part Number	Reel Size	Devices / Reel
CGB-1089Z	7"	1000

Package Marking

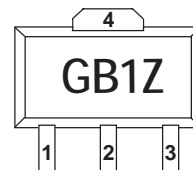

Suggested PCB Pad Layout
 Dimensions in inches [millimeters]

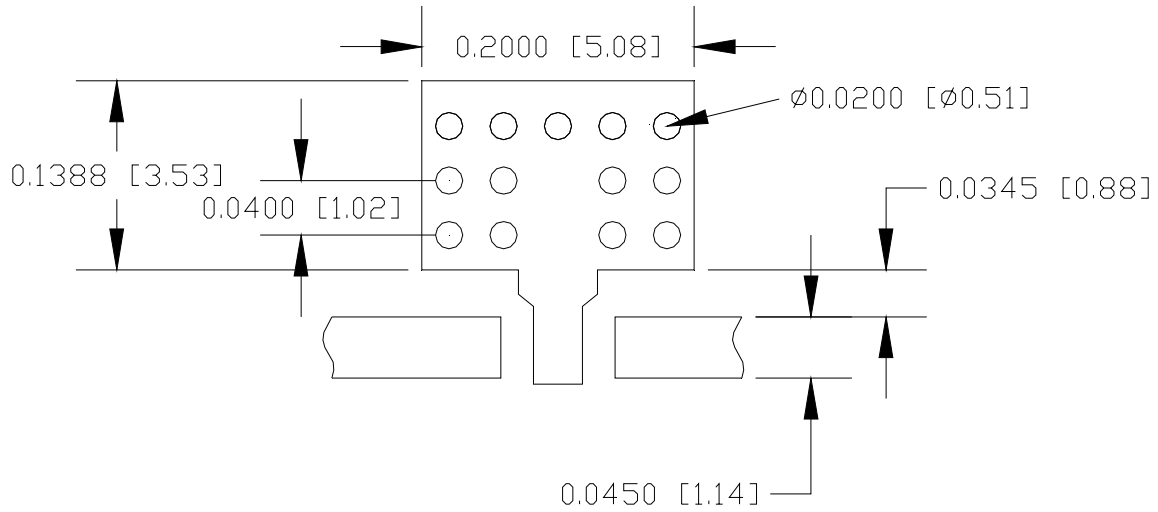

Nominal Package Dimensions

Dimensions in inches (millimeters)
 Refer to package drawing posted at www.sirenza.com for tolerances

