

DC-8.0 GHz InGaP HBT, MMIC or Packaged Matched Gain Block Amplifier



September 2006 - Rev 01-Sep-06

CGB7017-SC (-BD)
RoHS

Features

- ✕ Low Operating Voltage: 5V
- ✕ 33.8 dBm Output IP3 @ 850 MHz
- ✕ 3.3 dB Noise Figure @ 850 MHz
- ✕ 23.1 dB Gain @ 850 MHz, 19.5 dB @ 6 GHz
- ✕ 18.2 dBm P1dB @ 850 MHz
- ✕ Low Performance Variation Over Temperature
- ✕ Low Cost: Die Form or SOT-89 Package
- ✕ 100% DC On-Wafer Testing
- ✕ ESD Protection on All Die: >1000V HBM
- ✕ Low Thermal Resistance: <100°C/Watt

Description

The CGB7017-SC (-BD) is a Darlington Configured, high dynamic range, utility gain block amplifier. Designed for applications operating within the DC to 8.0 GHz frequency range, Mimix's broadband, cascadable, gain block amplifiers are ideal solutions for transmit, receive and IF applications.

These MMIC amplifiers are available in bare die form or an industry standard SOT-89 package. Mimix's InGaP HBT technology and an industry low thermal resistance offers a thermally robust and reliable gain block solution.

The InGaP HBT die have extra pads to enable thorough DC testing. This unique test capability and the inclusion of ESD protection on all die, significantly enhances the quality, reliability and ruggedness of these products.

With a single bypass capacitor, optional RF choke and two DC blocking capacitors, this gain block amplifier offers significant ease of use in a broad range of applications.

Functional Block Diagram (SOT-89)

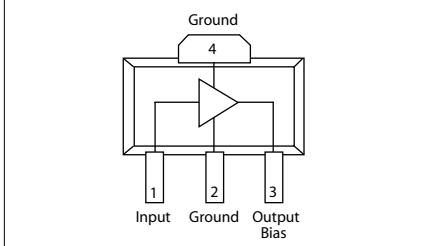

Absolute Maximum Ratings

Max Device Voltage	+6.0 V
Max Device Current	130 mA
Max Device Dissipated Power	0.65 W
RF Input Power	+17 dBm
Storage Temperature	-55°C to 150°C
Junction Temperature	150°C
Operating Temperature	-40°C to +85°C
Thermal Resistance	85° C/W
EDS (HBM)	1000 V

Operation of this device above any of these parameters may cause permanent damage.

Applications

- ✕ PA Driver Amp, IF Amp, LO Buffer Amp
- ✕ Cellular, PCS, GSM, UMTS
- ✕ Wireless Data and SATCOM
- ✕ Transmit and Receive Functions
- ✕ CATV

Electrical Characteristics

Unless otherwise specified, the following specifications are guaranteed at room temperature in a Mimix test fixture.

Parameter	Temperature (°C)	850 MHz			1950 MHz			2400 MHz			3500 MHz			6000 MHz			Units
		Min.	Typ.	Max.	Min.	Typ.	Max.	Min.	Typ.	Max.	Min.	Typ.	Max.	Min.	Typ.	Max.	
Small Signal Gain	+25	22.1	23.1	24.1	21.0	22.0	23.0	20.8	21.8	22.8		21.0			19.5		dB
	-40 to +85	22.0	23.1	24.2	20.9	22.0	23.1	20.7	21.8	22.9		21.0			19.5		dB
Output P1dB	+25	17.2	18.2		16.7	17.7		16.7	17.7			17.0			12.0		dBm
	-40 to +85	16.9	18.2		16.3	17.7		16.3	17.7			17.0			12.0		dBm
Output IP3	+25	32.3	33.8		31.4	32.9		30.2	31.7			27.6			20.3		dBm
	-40 to +85	31.8	33.8		30.9	32.9		29.7	31.7			27.6			20.3		dBm
Noise Figure	+25		3.3	4.1		3.6	4.4		3.7	4.5		3.8			4.6		dB
	-40 to +85		3.3	4.5		3.6	4.8		3.7	4.9		3.8			4.6		dB
Operating Current	+25	65	70	75	65	70	75	65	70	75		70			70		mA
	-40 to +85	59	70	79	59	70	79	59	70	79		70			70		mA
Input Return Loss	+25	11	15		11	16		11	15			11			7.5		dB
	-40 to +85	10	15		10	16		10	15			11			7.5		dB
Output Return Loss	+25	16	23		11	16		11	16			16			13		dB
	-40 to +85	15	23		10	16		10	16			16			13		dB
Pout @ -45 dBc, ACP IS-95, 9 Forward Channels	+25		12			12											dBm
	-40 to +85		12			12											dBm

Notes: 1. Test Conditions in Mimix eval board, Vs = 5 V, Id = 70 mA Typ., Rbias = 10 Ω, Zs = Zl = 50 Ω, OIP3 tone spacing = 1 MHz, Pout per tone = 6 dBm.
2. Values reflect performance in recommended application circuit.

Mimix Broadband, Inc., 10795 Rockley Rd., Houston, Texas 77099
Tel: 281.988.4600 Fax: 281.988.4615 mimixbroadband.com

Page 1 of 8

Characteristic Data and Specifications are subject to change without notice. ©2006 Mimix Broadband, Inc.
Export of this item may require appropriate export licensing from the U.S. Government. In purchasing these parts, U.S. Domestic customers accept their obligation to be compliant with U.S. Export Laws.

www.DataSheet4U.com

DC-8.0 GHz InGaP HBT, MMIC or Packaged Matched Gain Block Amplifier



September 2006 - Rev 01-Sep-06

CGB7017-SC (-BD)
RoHS

Typical S-Parameter and Noise Performance

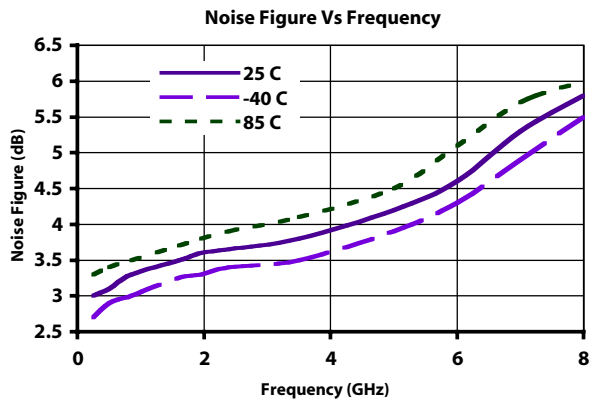
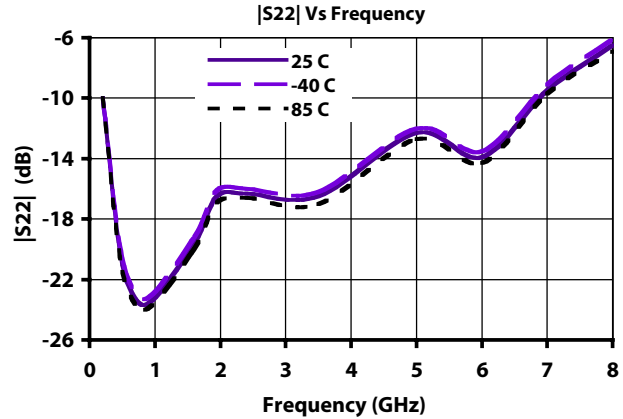
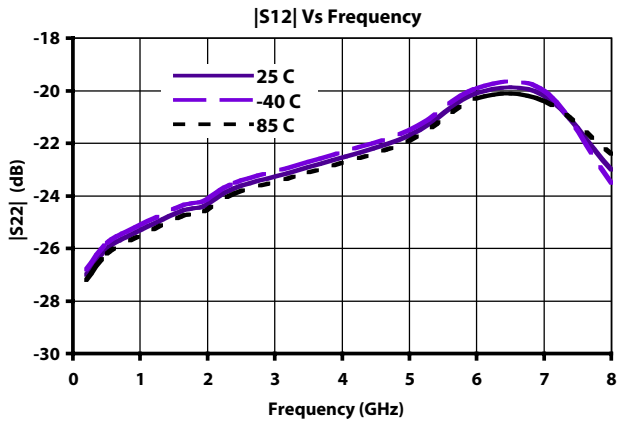
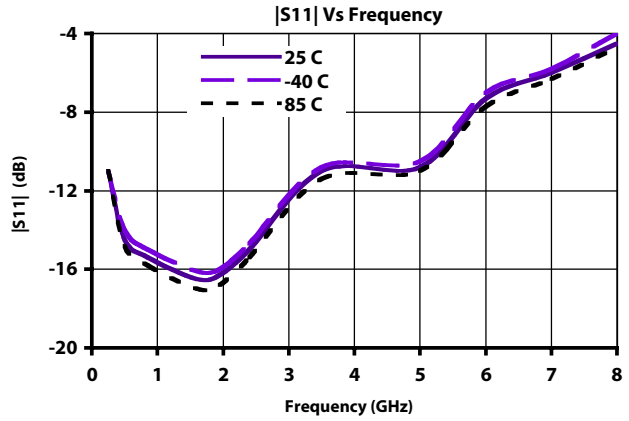
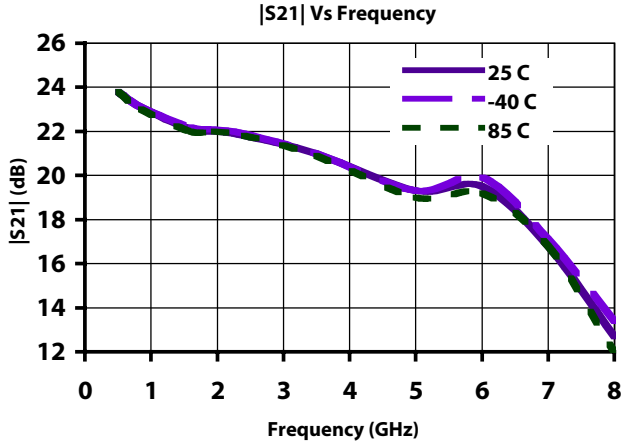

DC-8.0 GHz InGaP HBT, MMIC or Packaged Matched Gain Block Amplifier



September 2006 - Rev 01-Sep-06

CGB7017-SC (-BD)
RoHS

Typical Power and Linearity Performance

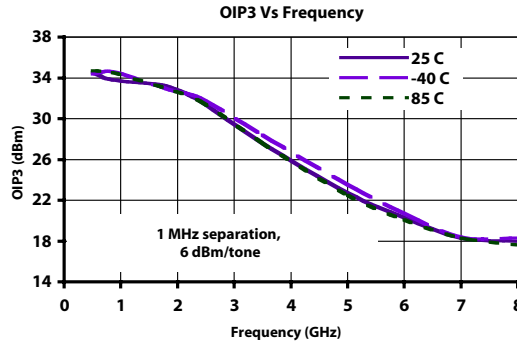
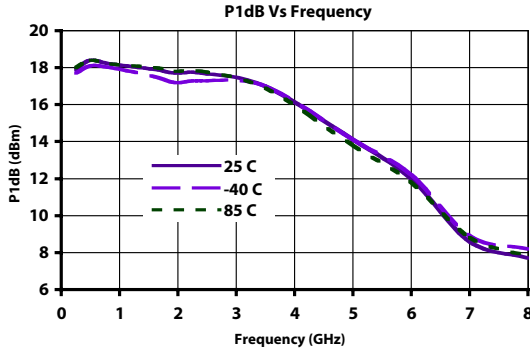

Linearity Performance - Base Station ACP - IS-95

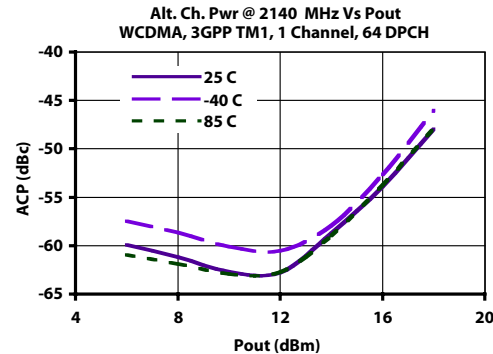
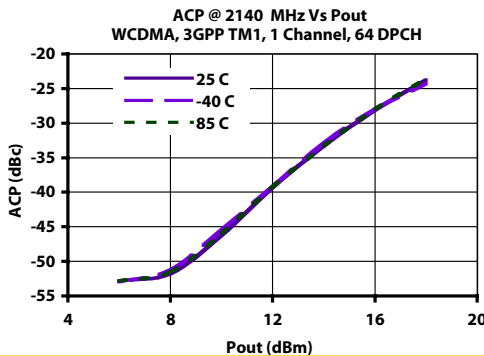
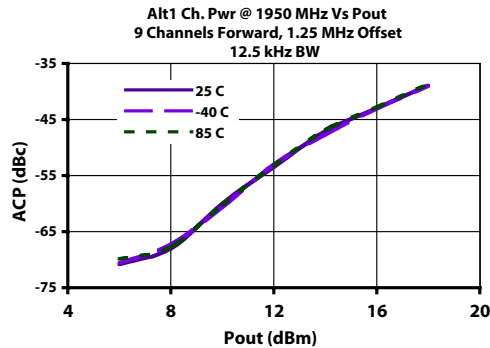
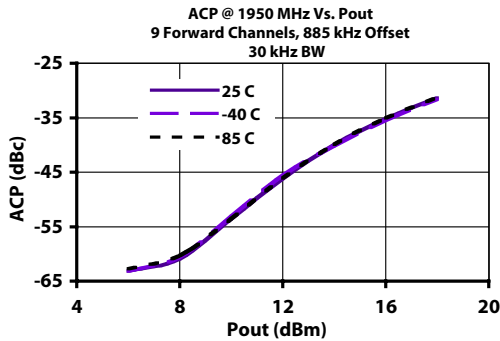
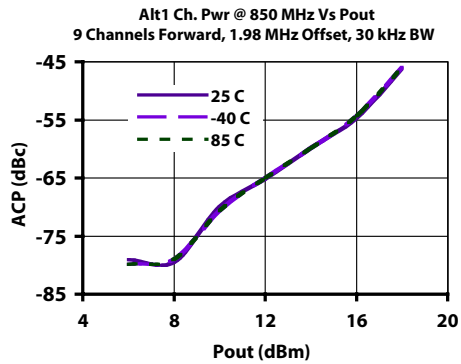
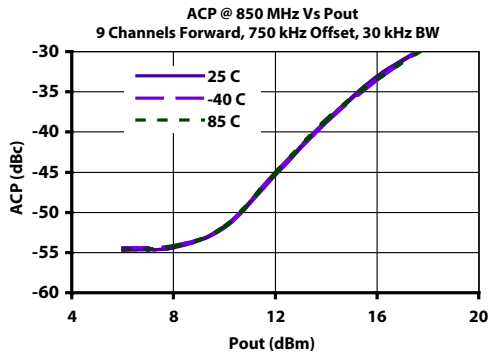

DC-8.0 GHz InGaP HBT, MMIC or Packaged Matched Gain Block Amplifier



September 2006 - Rev 01-Sep-06

CGB7017-SC (-BD)
 RoHS

Typical Scattering Parameters (Vd = +4.5V, Icc = 74 mA, T = 23°C, device in a 50 ohm system)

Frequency (MHz)	S ₁₁		S ₂₁		S ₁₂		S ₂₂	
	(Mag)	(Ang)	(Mag)	(Ang)	(Mag)	(Ang)	(Mag)	(Ang)
100	0.039	-164	15.58	175	0.054	-1	0.017	-130
200	0.043	-152	15.51	170	0.055	-2	0.026	-124
300	0.051	-144	15.45	164	0.055	-4	0.036	-120
400	0.058	-140	15.37	159	0.055	-5	0.046	-119
500	0.066	-136	15.27	154	0.055	-6	0.055	-119
600	0.075	-134	15.17	149	0.055	-7	0.065	-120
700	0.084	-134	15.06	144	0.055	-8	0.074	-122
800	0.094	-134	14.93	139	0.056	-10	0.083	-123
900	0.103	-134	14.81	134	0.056	-11	0.092	-124
1000	0.113	-134	14.68	130	0.057	-12	0.101	-126
1100	0.122	-135	14.54	125	0.057	-14	0.109	-128
1200	0.131	-136	14.40	120	0.057	-15	0.116	-130
1300	0.140	-137	14.25	115	0.058	-16	0.123	-132
1400	0.148	-139	14.08	110	0.059	-18	0.130	-134
1500	0.156	-140	13.93	106	0.059	-19	0.137	-136
1600	0.164	-142	13.77	101	0.060	-21	0.143	-138
1700	0.172	-144	13.61	96	0.060	-22	0.149	-140
1800	0.181	-145	13.44	92	0.061	-24	0.155	-142
1900	0.190	-147	13.28	87	0.062	-25	0.160	-144
2000	0.197	-149	13.12	83	0.062	-27	0.166	-146
2100	0.204	-151	12.96	78	0.063	-29	0.171	-147
2200	0.211	-153	12.80	74	0.064	-30	0.177	-149
2300	0.218	-155	12.64	69	0.065	-32	0.180	-151
2400	0.225	-157	12.49	65	0.065	-34	0.185	-153
2500	0.231	-159	12.33	60	0.066	-36	0.190	-154
2600	0.237	-162	12.19	56	0.067	-37	0.194	-156
2700	0.243	-164	12.04	52	0.068	-39	0.199	-158
2800	0.248	-167	11.89	47	0.069	-41	0.203	-160
2900	0.254	-169	11.75	43	0.070	-43	0.206	-162
3000	0.260	-171	11.61	39	0.070	-45	0.211	-163
3100	0.265	-173	11.49	35	0.072	-47	0.216	-165
3200	0.269	-176	11.38	31	0.073	-49	0.222	-167
3300	0.274	-179	11.27	26	0.074	-51	0.227	-169
3400	0.279	178	11.17	22	0.075	-53	0.231	-171
3500	0.285	175	11.07	18	0.076	-55	0.236	-173
3600	0.289	173	10.97	14	0.077	-57	0.242	-175
3700	0.293	169	10.89	10	0.078	-59	0.248	-178
3800	0.296	166	10.81	6	0.079	-61	0.254	179
3900	0.299	162	10.73	1	0.080	-64	0.259	176
4000	0.303	159	10.66	-3	0.082	-66	0.264	174
4100	0.306	155	10.58	-7	0.083	-68	0.268	171
4200	0.307	151	10.52	-11	0.084	-70	0.274	168
4300	0.308	147	10.46	-15	0.086	-73	0.279	164
4400	0.309	142	10.42	-20	0.087	-75	0.283	160
4500	0.310	138	10.36	-24	0.089	-78	0.287	157
4600	0.312	133	10.32	-28	0.090	-80	0.292	153
4700	0.313	128	10.28	-33	0.091	-83	0.297	149
4800	0.312	122	10.24	-37	0.093	-86	0.302	145
4900	0.313	117	10.22	-41	0.095	-89	0.307	140
5000	0.314	110	10.19	-46	0.096	-91	0.311	135

Continues Next Page. S-Parameter Data Files are available online at: www.mimixbroadband.com

Mimix Broadband, Inc., 10795 Rockley Rd., Houston, Texas 77099
 Tel: 281.988.4600 Fax: 281.988.4615 mimixbroadband.com

Page 4 of 8

Characteristic Data and Specifications are subject to change without notice. ©2006 Mimix Broadband, Inc.
 Export of this item may require appropriate export licensing from the U.S. Government. In purchasing these parts, U.S. Domestic customers accept their obligation to be compliant with U.S. Export Laws.

DC-8.0 GHz InGaP HBT, MMIC or Packaged Matched Gain Block Amplifier



September 2006 - Rev 01-Sep-06

CGB7017-SC (-BD)
 RoHS

Typical Scattering Parameters (Vd = +4.5V, Icc = 74 mA, T = 23°C, device in a 50 ohm system)

Frequency (MHz)	S ₁₁		S ₂₁		S ₁₂		S ₂₂	
	(Mag)	(Ang)	(Mag)	(Ang)	(Mag)	(Ang)	(Mag)	(Ang)
5100	0.315	104	10.15	-51	0.098	-94	0.314	130
5200	0.316	97	10.13	-55	0.100	-97	0.319	125
5300	0.317	91	10.11	-60	0.101	-100	0.324	120
5400	0.319	83	10.08	-65	0.103	-104	0.330	114
5500	0.323	75	10.05	-69	0.105	-107	0.335	108
5600	0.329	67	10.03	-74	0.106	-110	0.341	101
5700	0.337	59	9.99	-79	0.108	-114	0.347	95
5800	0.346	51	9.96	-84	0.109	-117	0.354	88
5900	0.355	42	9.90	-90	0.110	-121	0.361	81
6000	0.367	33	9.84	-95	0.112	-125	0.369	73
6100	0.384	24	9.76	-100	0.113	-129	0.378	66
6200	0.401	15	9.66	-106	0.113	-133	0.386	58
6300	0.420	7	9.56	-111	0.114	-137	0.397	51
6400	0.441	-2	9.43	-117	0.115	-141	0.408	43
6500	0.463	-10	9.29	-123	0.115	-145	0.421	35
6600	0.487	-19	9.13	-128	0.114	-149	0.435	27
6700	0.513	-26	8.93	-134	0.114	-153	0.448	19
6800	0.537	-34	8.73	-140	0.113	-158	0.462	12
6900	0.561	-42	8.50	-145	0.112	-162	0.477	4
7000	0.586	-49	8.27	-151	0.110	-166	0.492	-3
7100	0.609	-56	8.00	-157	0.109	-170	0.505	-11
7200	0.632	-63	7.72	-162	0.106	-174	0.518	-18
7300	0.652	-70	7.44	-168	0.104	-178	0.531	-25
7400	0.670	-76	7.17	-173	0.102	178	0.542	-31
7500	0.688	-82	6.88	-178	0.099	174	0.554	-38
7600	0.703	-88	6.59	176	0.096	170	0.565	-44
7700	0.718	-94	6.31	171	0.094	167	0.575	-49
7800	0.730	-99	6.02	166	0.091	163	0.584	-55
7900	0.741	-104	5.76	162	0.089	160	0.592	-60
8000	0.749	-109	5.50	157	0.086	157	0.599	-65
8100	0.757	-114	5.24	152	0.083	153	0.607	-70
8200	0.766	-119	5.00	148	0.081	151	0.613	-75
8300	0.772	-123	4.75	144	0.078	148	0.619	-80
8400	0.776	-128	4.53	139	0.076	145	0.625	-84
8500	0.779	-132	4.33	135	0.074	142	0.629	-88
8600	0.782	-136	4.13	131	0.072	139	0.633	-92
8700	0.783	-140	3.93	127	0.069	137	0.638	-95
8800	0.786	-144	3.75	123	0.067	134	0.642	-99
8900	0.787	-147	3.58	120	0.065	132	0.644	-103
9000	0.786	-151	3.42	116	0.064	130	0.647	-106
9100	0.785	-155	3.27	112	0.062	128	0.650	-109
9200	0.784	-158	3.13	109	0.060	126	0.652	-112
9300	0.783	-162	2.99	105	0.059	123	0.654	-115
9400	0.781	-165	2.86	102	0.057	121	0.656	-118
9500	0.777	-168	2.74	98	0.056	119	0.658	-121
9600	0.773	-171	2.62	95	0.055	117	0.660	-124
9700	0.769	-175	2.51	91	0.054	115	0.661	-127
9800	0.765	-178	2.41	88	0.053	113	0.663	-129
9900	0.762	179	2.31	85	0.052	112	0.664	-132
10000	0.756	176	2.21	81	0.051	110	0.665	-134

S-Parameter Data Files are available online at: www.mimixbroadband.com

Mimix Broadband, Inc., 10795 Rockley Rd., Houston, Texas 77099
 Tel: 281.988.4600 Fax: 281.988.4615 mimixbroadband.com

Page 5 of 8

Characteristic Data and Specifications are subject to change without notice. ©2006 Mimix Broadband, Inc.
 Export of this item may require appropriate export licensing from the U.S. Government. In purchasing these parts, U.S. Domestic customers accept their obligation to be compliant with U.S. Export Laws.

DC-8.0 GHz InGaP HBT, MMIC or Packaged Matched Gain Block Amplifier



September 2006 - Rev 01-Sep-06

CGB7017-SC (-BD)
RoHS

Application Circuit

Note: This schematic represents the topology of the application circuit recommended by Mimix.

Supply Voltage (V)	5V	7V	8V	10V
Rbias (R1 Description: 1206 1/4W 1%)	10Ω	38Ω	—	—
Rbias (R1 Description: 1210 1/2W 1%)	—	—	52Ω	81Ω

Note: Rbias provides DC bias stability over temperature.

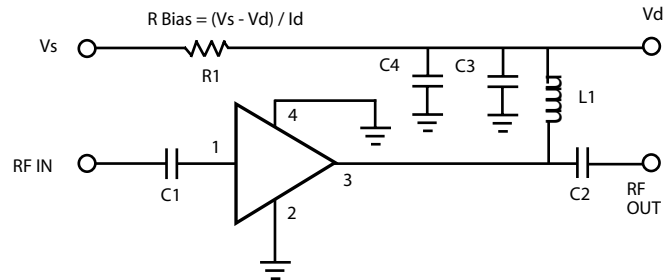

Application Circuit for Flat Gain @ 2 to 6 GHz

Note: This schematic represents the topology of the application circuit recommended by Mimix.

Supply Voltage (V)	5V	7V	8V	10V
Rbias (R1 Description: 1206 1/4W 1%)	10Ω	38Ω	—	—
Rbias (R1 Description: 1210 1/2W 1%)	—	—	52Ω	81Ω

Note: Rbias provides DC bias stability over temperature.

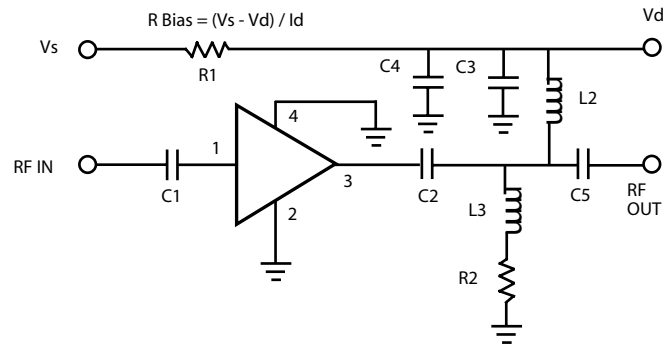

Typical Gain Performance

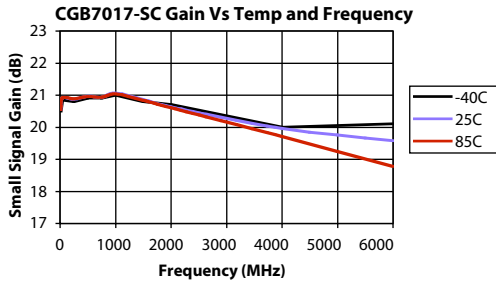

Evaluation Board - SC Package (SOT-89)

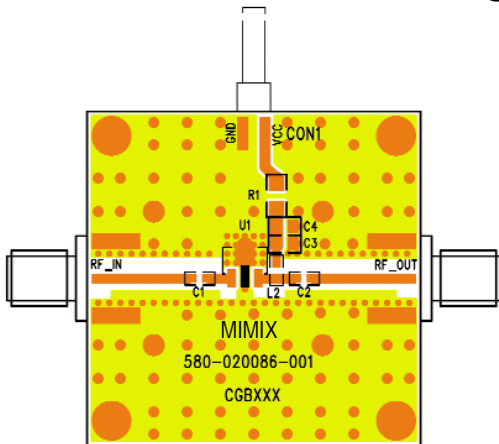

Ref Designator	Value	Description	Size
C1, C2, C3	1000 pF	MCH185A101JK	0805
C4	1.0 μF	VITR 1.0 μF 25V CER CAP 0805 X7R 10%	0805
L1	56 nH	Coilcraft 0603 CS 10%	0603
L1	470 nH	Coilcraft 0805 CS 10%	0805
L3	6.8 nH	Coilcraft 0603 CS 10%	0603
R1		R Bias = (V _s - V _d) / I _d	1206 / 1210
R2	75 Ω	1206 1/4W	1206
C4		DNP (Do Not Place)	N/A

Note: Contact factory for matching recommendations if flat gain is required from 2 to 6 GHz.

DC-8.0 GHz InGaP HBT, MMIC or Packaged Matched Gain Block Amplifier



September 2006 - Rev 01-Sep-06

CGB7017-SC (-BD)
 RoHS

Physical Dimensions - SC Package (SOT-89)

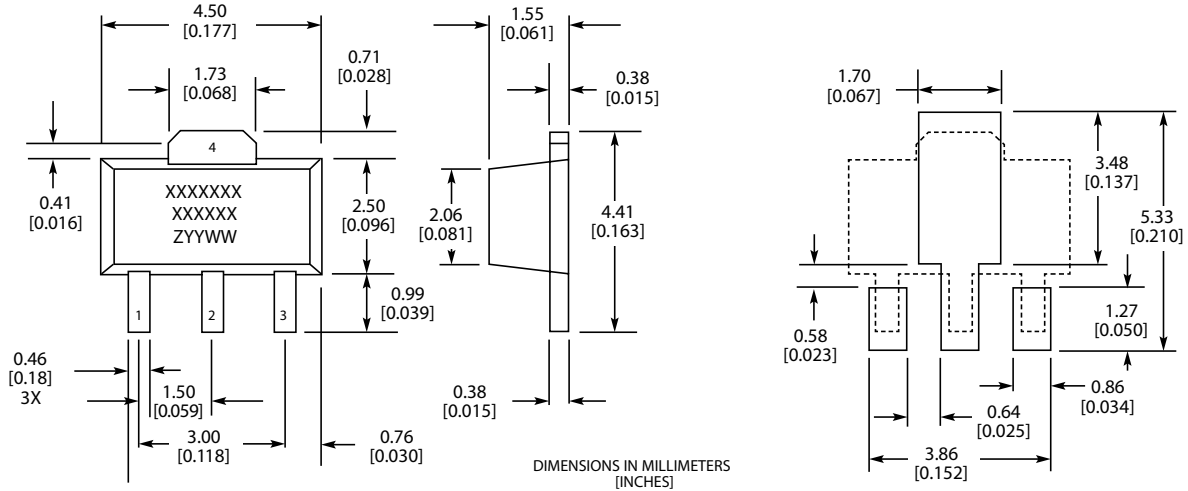

MARKINGS:
 XXXXXXXX = MIMIX MODEL NO.
 XXXXXX = WAFER LOT NO.
 ZYYWW = DATE CODE (YR/WEEK)
 FIRST LETTER COUNTRY OF ORIGIN IF OTHER THAN USA

Physical Dimensions - BD (Bare Die)

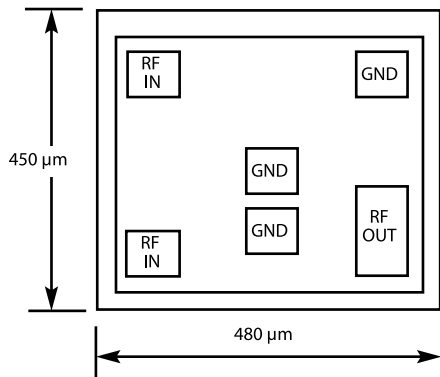

Notes:
 RF OUT bonding pad is 75 μm x 155 μm.
 All other pads are 75 μm x 75 μm.



DC-8.0 GHz InGaP HBT, MMIC or Packaged Matched Gain Block Amplifier



September 2006 - Rev 01-Sep-06

CGB7017-SC (-BD)
RoHS

Handling and Assembly Information

CAUTION! - Mimix Broadband MMIC Products contain gallium arsenide (GaAs) which can be hazardous to the human body and the environment. For safety, observe the following procedures:

- Do not ingest.
- Do not alter the form of this product into a gas, powder, or liquid through burning, crushing, or chemical processing as these by-products are dangerous to the human body if inhaled, ingested, or swallowed.
- Observe government laws and company regulations when discarding this product. This product must be discarded in accordance with methods specified by applicable hazardous waste procedures.

Life Support Policy - Mimix Broadband's products are not authorized for use as critical components in life support devices or systems without the express written approval of the President and General Counsel of Mimix Broadband. As used herein: (1) Life support devices or systems are devices or systems which, (a) are intended for surgical implant into the body, or (b) support or sustain life, and whose failure to perform when properly used in accordance with instructions for use provided in the labeling, can be reasonably expected to result in a significant injury to the user. (2) A critical component is any component of a life support device or system whose failure to perform can be reasonably expected to cause the failure of the life support device or system, or to affect its safety or effectiveness.

Package Attachment - This packaged product from Mimix Broadband is provided as a rugged surface mount package compatible with high volume solder installation. Care should be taken not to apply heavy pressure to the top or base material to avoid package damage. Vacuum tools or other suitable pick and place equipment may be used to pick and place this part. Care should be taken to ensure that there are no voids or gaps in the solder connection so that good RF, DC and ground connections are maintained. Voids or gaps can eventually lead not only to RF performance degradation, but reduced reliability and life of the product due to thermal stress.

Mimix Lead-Free RoHS Compliant Program - Mimix has an active program in place to meet customer and governmental requirements for eliminating lead (Pb) and other environmentally hazardous materials from our products. All Mimix RoHS compliant components are form, fit and functional replacements for their non-RoHS equivalents. Lead plating of our RoHS compliant parts is 100% matt tin (Sn) over copper alloy and is backwards compatible with current standard SnPb low-temperature reflow processes as well as higher temperature (260°C reflow) "Pb Free" processes.

Ordering Information

Part Number for Ordering	Description
CGB7017-BD	Bare die in GelPak
CGB7017-SC-0G00	Matte Tin plated RoHS compliant SOT-89 surface mount package in bulk quantity
CGB7017-SC-0G0T	Matte Tin plated RoHS compliant SOT-89 surface mount package in tape and reel
CGB7017-SP-0G00	Matte Tin plated RoHS compliant SOT-86 surface mount package in bulk quantity
CGB7017-SP-0G0T	Matte Tin plated RoHS compliant SOT-86 surface mount package in tape and reel
PB-CGB7017-SC-0000	Evaluation Board for SOT-89 packaged device with SMA connectors
PB-CGB7017-SP-0000	Evaluation Board for SOT-86 packaged device with SMA connectors

We also offer the plastic packages with SnPb (Tin-Lead) or NiPdAu plating. Please contact your regional sales manager for more information regarding different plating types