

CGH40120F

120 W, RF Power GaN HEMT

Cree's CGH40120F is an unmatched, gallium nitride (GaN) high electron mobility transistor (HEMT). The CGH40120F, operating from a 28 volt rail, offers a general purpose, broadband solution to a variety of RF and microwave applications. GaN HEMTs offer high efficiency, high gain and wide bandwidth capabilities making the CGH40120F ideal for linear and compressed amplifier circuits. The transistor is available in a flange package.



Package Types: 440193
PN: CGH40120F

FEATURES

- Up to 2.5 GHz Operation
- 20 dB Small Signal Gain at 1.0 GHz
- 15 dB Small Signal Gain at 2.0 GHz
- 120 W Typical P_{SAT}
- 70 % Efficiency at P_{SAT}
- 28 V Operation

APPLICATIONS

- 2-Way Private Radio
- Broadband Amplifiers
- Cellular Infrastructure
- Test Instrumentation
- Class A, AB, Linear amplifiers suitable for OFDM, W-CDMA, EDGE, CDMA waveforms



Absolute Maximum Ratings (not simultaneous) at 25°C Case Temperature

Parameter	Symbol	Rating	Units	Conditions
Drain-Source Voltage	V_{DSS}	84	Volts	25°C
Gate-to-Source Voltage	V_{GS}	-10, +2	Volts	25°C
Storage Temperature	T_{STG}	-65, +150	°C	
Operating Junction Temperature	T_J	225	°C	
Maximum Forward Gate Current	I_{GMAX}	30	mA	25°C
Maximum Drain Current ¹	I_{DMAX}	12	A	25°C
Soldering Temperature ²	T_S	245	°C	
Screw Torque	τ	80	in-oz	
Thermal Resistance, Junction to Case ³	R_{JJC}	1.39	°C/W	85°C
Case Operating Temperature ^{3,4}	T_C	-40, +150	°C	

Note:

¹ Current limit for long term, reliable operation

² Refer to the Application Note on soldering at www.cree.com/RF/Document-Library

³ Measured for the CGH40120F at $P_{DISS} = 115$ W.

⁴ See also, the Power Dissipation De-rating Curve on Page 7.

Electrical Characteristics ($T_c = 25^\circ\text{C}$)

Characteristics	Symbol	Min.	Typ.	Max.	Units	Conditions
DC Characteristics¹						
Gate Threshold Voltage	$V_{GS(th)}$	-3.8	-3.0	-2.3	V_{DC}	$V_{DS} = 10$ V, $I_D = 28.8$ mA
Gate Quiescent Voltage	$V_{GS(Q)}$	-	-2.7	-	V_{DC}	$V_{DS} = 28$ V, $I_D = 1.0$ A
Saturated Drain Current ²	I_{DS}	23.2	28.0	-	A	$V_{DS} = 6.0$ V, $V_{GS} = 2.0$ V
Drain-Source Breakdown Voltage	V_{BR}	120	-	-	V_{DC}	$V_{GS} = -8$ V, $I_D = 28.8$ mA
RF Characteristics³ ($T_c = 25^\circ\text{C}$, $F_0 = 1.3$ GHz unless otherwise noted)						
Small Signal Gain	G_{SS}	17.5	19	-	dB	$V_{DD} = 28$ V, $I_{DQ} = 1.0$ A
Power Output ⁴	P_{SAT}	100	120	-	W	$V_{DD} = 28$ V, $I_{DQ} = 1.0$ A
Drain Efficiency ⁵	η	55	70	-	%	$V_{DD} = 28$ V, $I_{DQ} = 1.0$ A, $P_{OUT} = P_{SAT}$
Output Mismatch Stress	VSWR	-	-	10 : 1	Ψ	No damage at all phase angles, $V_{DD} = 28$ V, $I_{DQ} = 1.0$ A, $P_{OUT} = 100$ W CW
Dynamic Characteristics						
Input Capacitance	C_{GS}	-	35.3	-	pF	$V_{DS} = 28$ V, $V_{gs} = -8$ V, $f = 1$ MHz
Output Capacitance	C_{DS}	-	9.1	-	pF	$V_{DS} = 28$ V, $V_{gs} = -8$ V, $f = 1$ MHz
Feedback Capacitance	C_{GD}	-	1.6	-	pF	$V_{DS} = 28$ V, $V_{gs} = -8$ V, $f = 1$ MHz

Notes:

¹ Measured on wafer prior to packaging.

² Scaled from PCM data.

³ Measured in CGH40120F-AMP

⁴ P_{SAT} is defined as $I_G = 2.8$ mA.

⁵ Drain Efficiency = P_{OUT} / P_{DC}

Typical Performance

Gain and Input Return Loss vs Frequency measured in
Broadband Amplifier Circuit CGH40120F-AMP

$V_{DD} = 28\text{ V}$, $I_{DQ} = 1.0\text{ A}$

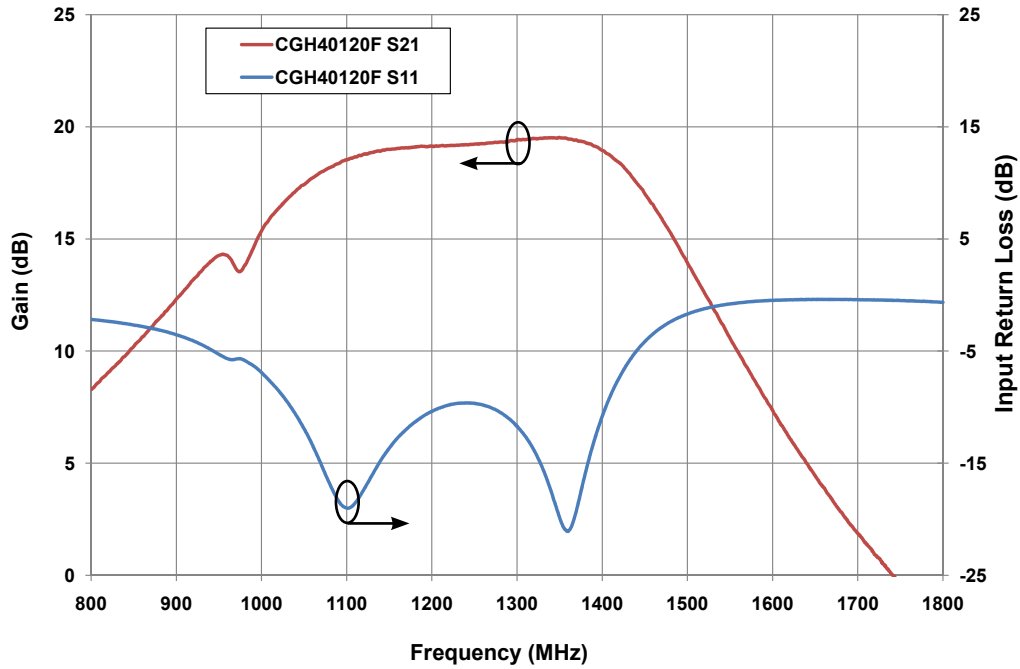

Gain, Output Power and PAE vs Frequency measured in
Broadband Amplifier Circuit CGH40120F-AMP

$V_{DD} = 28\text{ V}$, $I_{DQ} = 1.0\text{ A}$

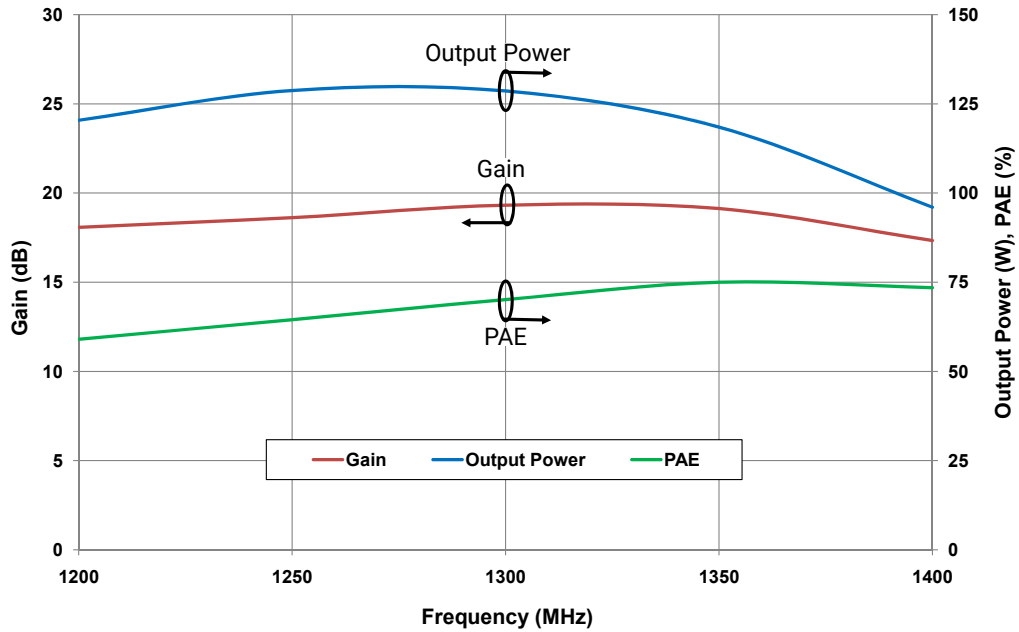

Typical 800 MHz - 1300 MHz Performance

Gain, Output Power, and Power Added Efficiency vs Frequency
 measured in 0.8-1.3 GHz Amplifier Circuit 03-000255

$V_{DD} = 28\text{ V}$, $I_{DQ} = 1.0\text{ A}$

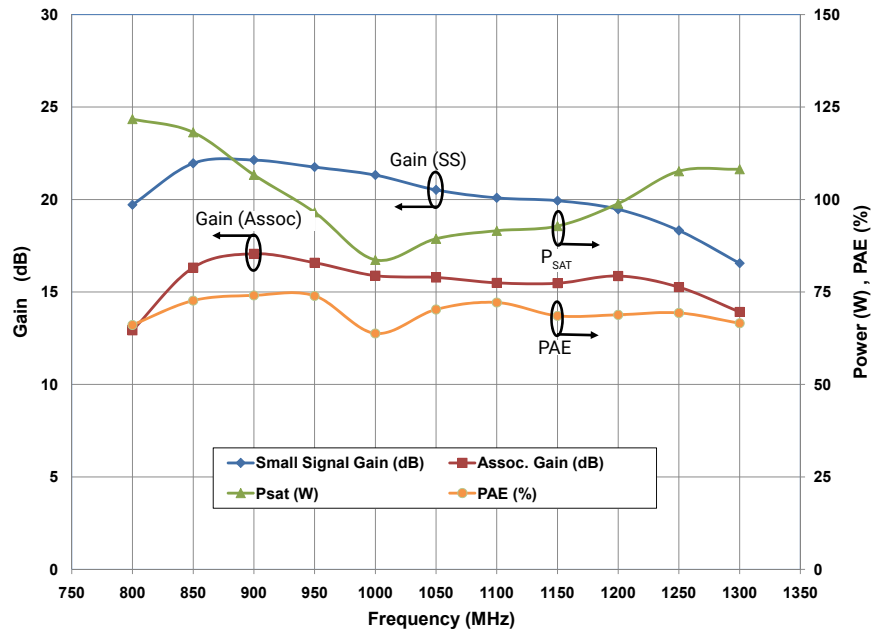

Typical Digital Video Broadcast (DVB) Performance

Output Power and Power Added Efficiency vs Frequency
 measured in DVB Amplifier Circuit 03-000256

$V_{DD} = 32\text{ V}$, $I_{DQ} = 1.0\text{ A}$

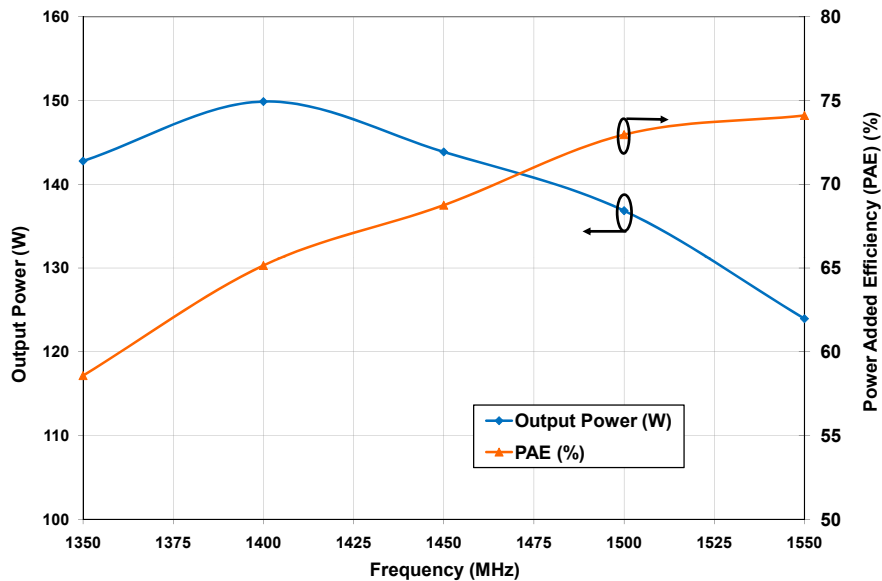

Typical Digital Video Broadcast (DVB) Performance

Small Signal Gain and Return Loss vs Frequency of the CGH40120F measured in DVB Amplifier Circuit 03-000256.

$V_{DD} = 32 \text{ V}$, $I_{DQ} = 1.0 \text{ A}$

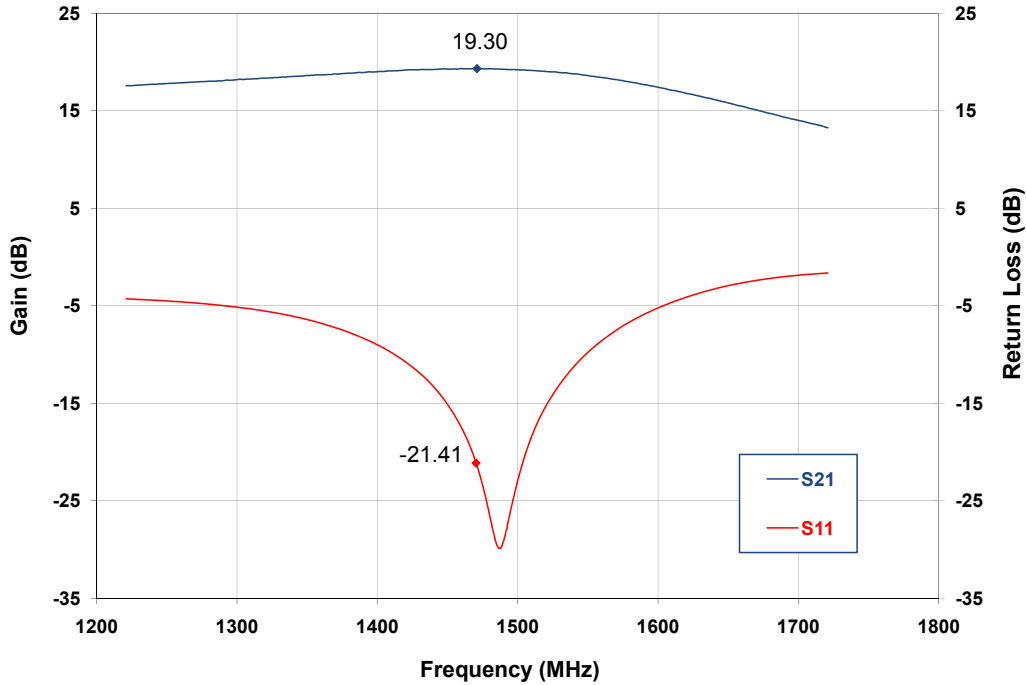

Typical Constellation Chart and Spectral Mask using 16QAM OFDM for a CGH40120F in DVB Amplifier Circuit 03-000256 at 1450 MHz.

$V_{DD} = 32 \text{ V}$, $I_{DQ} = 1.0 \text{ A}$, $P_{AVE} = 40 \text{ W}$, Drain Efficiency = 40 %, Signal PAR = 5.3 dB

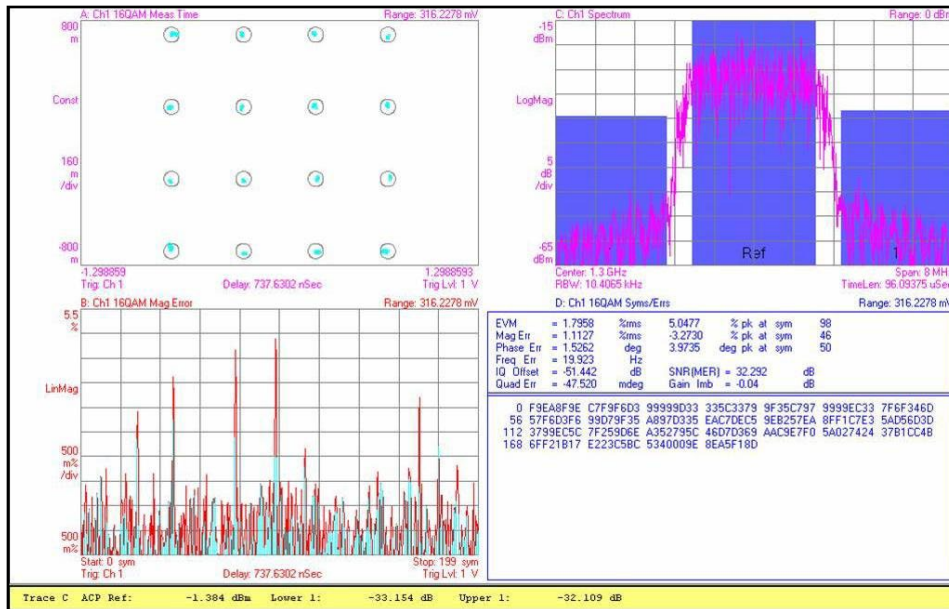

Typical Performance

Simulated Maximum Available Gain and K Factor of the CGH40120F
 $V_{DD} = 28\text{ V}, I_{DQ} = 1.0\text{ A}$

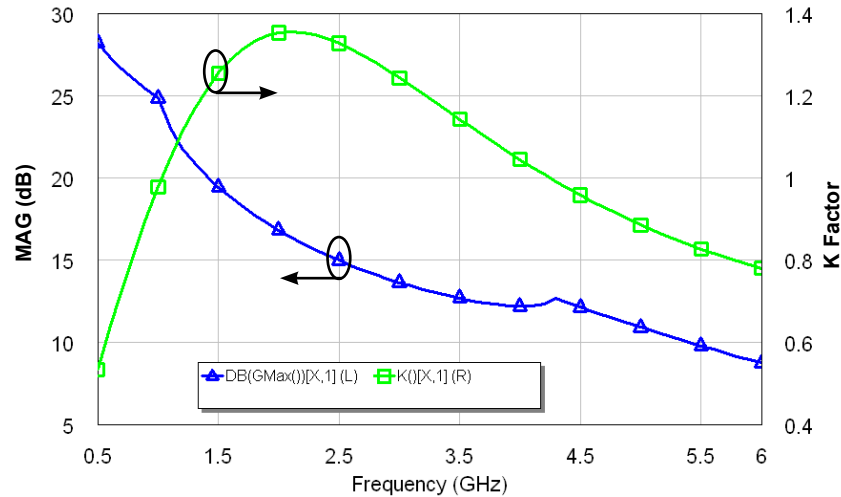

Typical Noise Performance

Simulated Minimum Noise Figure and Noise Resistance vs Frequency of the CGH40120F
 $V_{DD} = 28\text{ V}, I_{DQ} = 1\text{ A}$

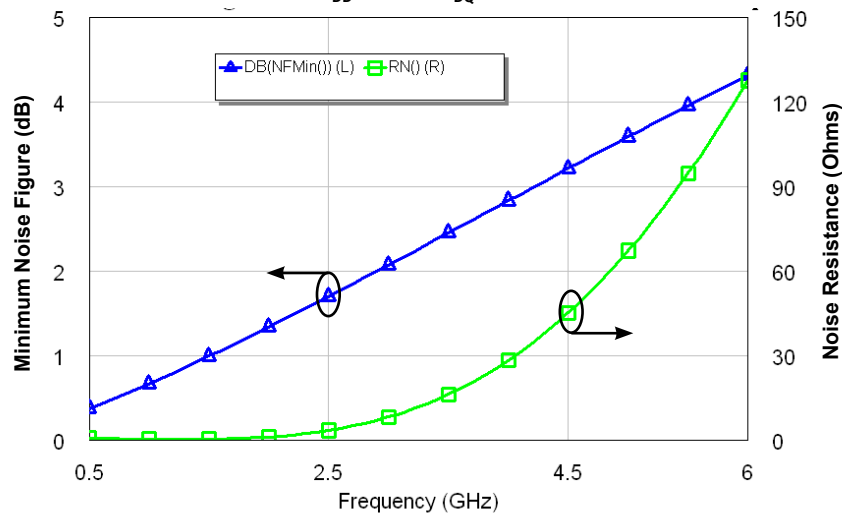

Electrostatic Discharge (ESD) Classifications

Parameter	Symbol	Class	Test Methodology
Human Body Model	HBM	1A > 250 V	JEDEC JESD22 A114-D
Charge Device Model	CDM	1 < 200 V	JEDEC JESD22 C101-C

CGH40120F CW Power Dissipation De-rating Curve

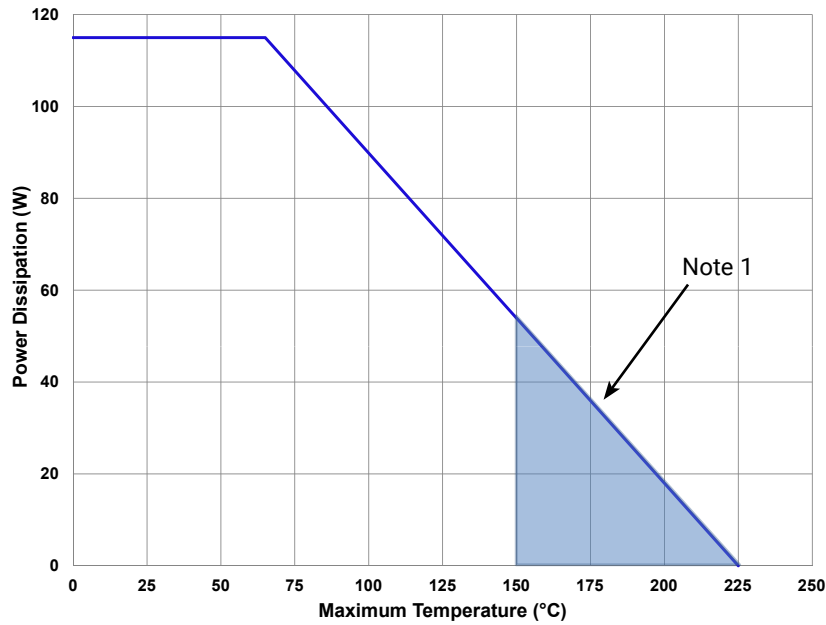

Note 1. Area exceeds Maximum Case Operating Temperature (See Page 2).

Source and Load Impedances

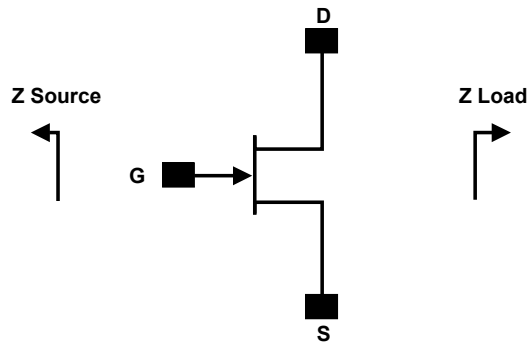

Frequency (MHz)	Z Source	Z Load
500	2 + j3.3	5.14 + j0.04
1000	0.81 + j0.18	4.68 - j0.26
1500	0.75 - j1.56	3.44 - j0.77
2000	0.84 - j3	2.34 - j0.95
2500	1.2 - j4.43	2.7 - j2.56
3000	1.09 - j5.9	3.06 - j3.82

Note 1. $V_{DD} = 28V$, $I_{DQ} = 1.0 A$ in the 440193 package.

Note 2. Optimized for power gain, P_{SAT} and PAE.

Note 3. When using this device at low frequency, series resistors should be used to maintain amplifier stability.

CGH40120F-AMP Demonstration Amplifier Circuit Bill of Materials

Designator	Description	Qty
C1, C30	CAP, 27 PF +/- 5%, 250V, 0805, ATC 600F	2
C2	CAP, 1.2 pF, +/- 0.1 pF, 0603, ATC 600S	1
C3, C4	CAP, 3.9 pF, +/- 0.1 pF, 0603, ATC 600S	2
C5, C6	CAP, 4.7 pF, +/- 0.1 pF, 0603, ATC 600S	2
C11, C31	CAP, 27pF,+/-5%, 0603, ATC 600S	2
C12, C32	CAP, 100 pF, +/- 5%, 0603, ATC 600S	2
C13, C33	CAP, 470 pF +/- 5%,100 V, 0603, Murata	2
C14, C34	CAP, CER, 33000 pF, 100V, X7R, 0805, Murata	2
C15	CAP, 10 uF, 16V, SMT, TANTALUM	1
C35	CAP, CER, 1.0 uF, 100V, +/- 10%, X7R, 1210	1
C36	CAP, 33 uF, 100V, ELECT, FK, SMD	1
C20, C21	CAP, 5.6 PF +/- 0.1 pF, 0805, ATC 600F	2
C22, C23	CAP, 0.5 PF +/- 0.05 pF, 0805, ATC 600F	2
C24, C25	CAP, 1.2 PF +/- 0.1 pF, 0805, ATC 600F	2
R1	RES, 1/16W, 0603, 511 Ohms (≤5% tolerance)	1
R2	RES, 1/16W, 0603, 5.1 Ohms (≤5% tolerance)	1
L1	IND, 6.8 nH, 0603, L-14C6N8ST	1
L2	IND, FERRITE, 220 OHM, 0805, BLM21PG221SN1	1
J1, J2	CONN, N-Type, Female, 0.500 SMA Flange	2
J3	CONN, Header, RT> PLZ, 0.1 CEN, LK, 9 POS	1
-	PCB, RO4003, Er = 3.38, h = 32 mil	1
Q1	CGH40120F	1

CGH40120F-AMP Demonstration Amplifier Circuit

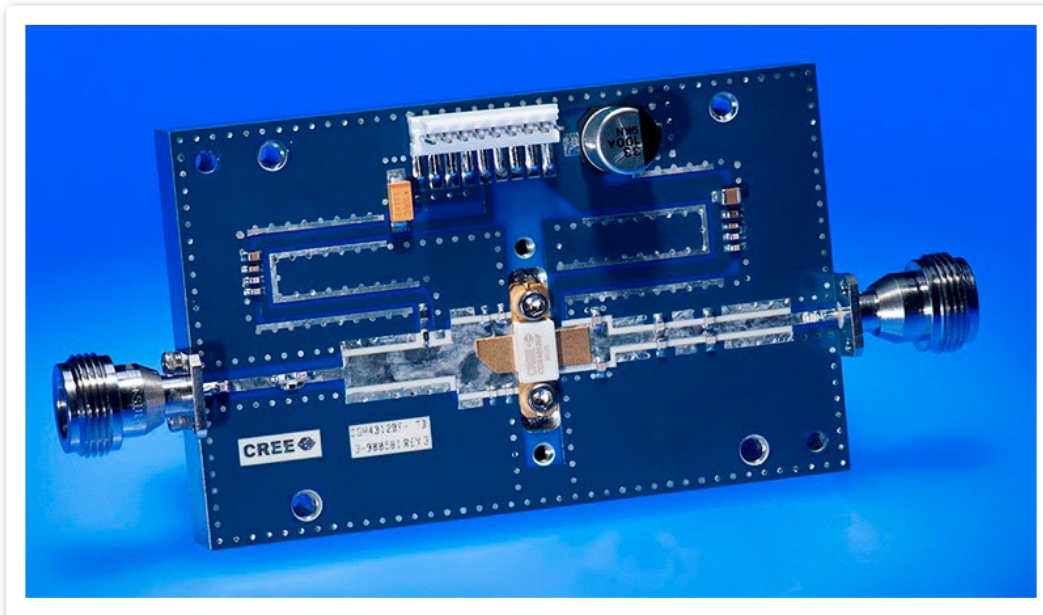

CGH40120F-AMP Demonstration Amplifier Circuit Schematic

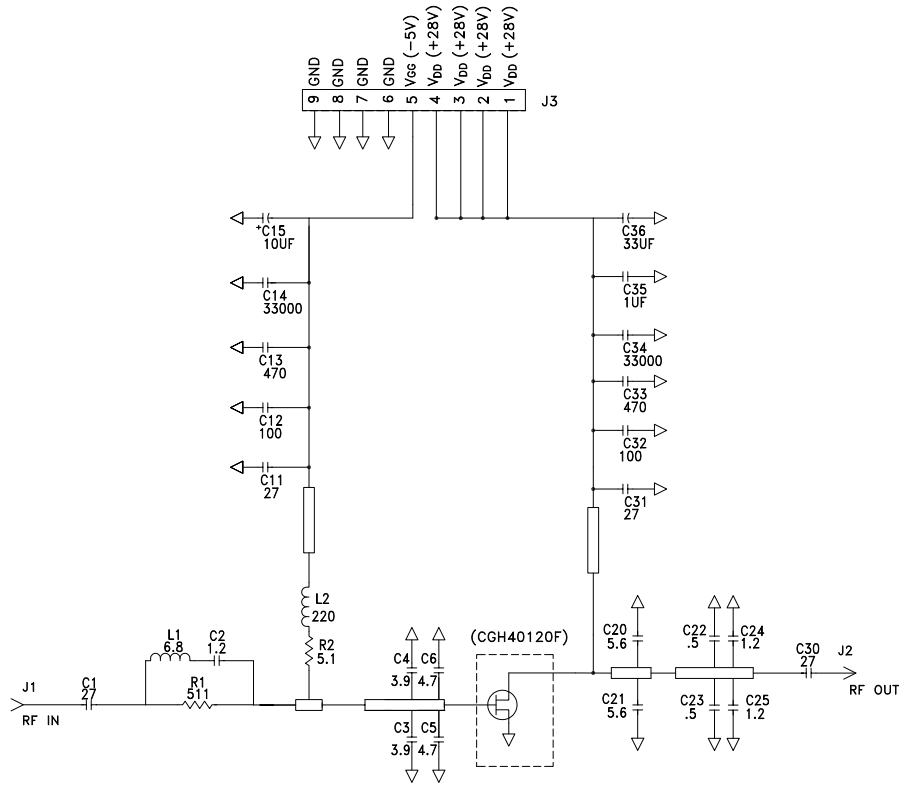

CGH40120F-AMP Demonstration Amplifier Circuit Outline

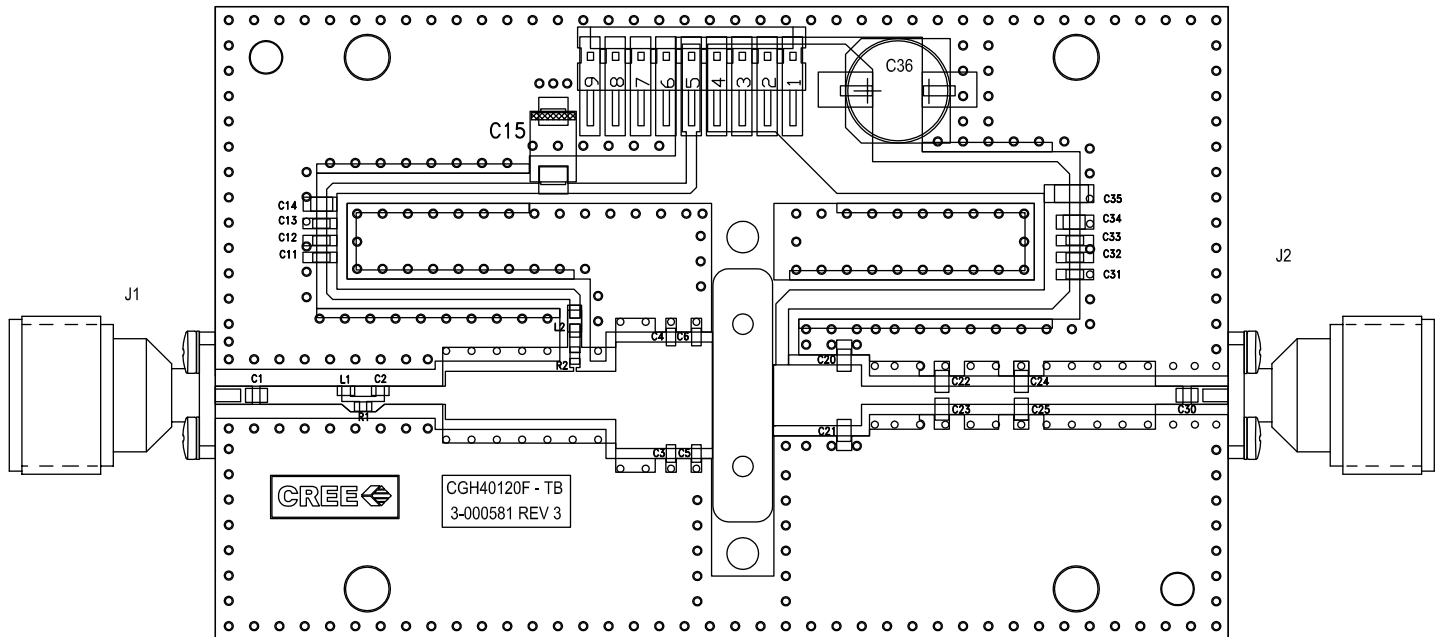

Typical Package S-Parameters for CGH40120F
 (Small Signal, $V_{DS} = 28\text{ V}$, $I_{DQ} = 1.0\text{ A}$, angle in degrees)

Frequency	Mag S11	Ang S11	Mag S21	Ang S21	Mag S12	Ang S12	Mag S22	Ang S22
500 MHz	0.961	-177.60	4.19	80.16	0.006	13.42	0.807	-179.57
600 MHz	0.961	-178.85	3.49	77.38	0.006	15.30	0.808	-179.85
700 MHz	0.961	-179.89	2.99	74.72	0.006	17.30	0.810	179.89
800 MHz	0.961	179.22	2.61	72.16	0.007	19.36	0.811	179.66
900 MHz	0.961	178.41	2.32	69.66	0.007	21.47	0.813	179.42
1.0 GHz	0.960	177.67	2.09	67.22	0.007	23.59	0.815	179.18
1.1 GHz	0.960	176.96	1.89	64.83	0.007	25.71	0.817	178.94
1.2 GHz	0.960	176.28	1.73	62.49	0.007	27.81	0.819	178.68
1.3 GHz	0.960	175.63	1.60	60.18	0.007	29.86	0.822	178.41
1.4 GHz	0.960	174.99	1.48	57.92	0.008	31.86	0.824	178.13
1.5 GHz	0.960	174.36	1.38	55.69	0.008	33.80	0.826	177.83
1.6 GHz	0.960	173.73	1.30	53.50	0.008	35.65	0.828	177.52
1.7 GHz	0.960	173.11	1.22	51.35	0.008	37.40	0.830	177.19
1.8 GHz	0.959	172.49	1.15	49.23	0.009	39.06	0.832	176.84
1.9 GHz	0.959	171.86	1.10	47.15	0.009	40.61	0.835	176.47
2.0 GHz	0.959	171.23	1.04	45.09	0.010	42.04	0.837	176.09
2.1 GHz	0.958	170.59	0.99	43.07	0.010	43.36	0.839	175.69
2.2 GHz	0.958	169.95	0.95	41.08	0.011	44.56	0.840	175.28
2.3 GHz	0.957	169.29	0.91	39.12	0.011	45.64	0.842	174.85
2.4 GHz	0.957	168.63	0.88	37.18	0.012	46.60	0.844	174.40
2.5 GHz	0.956	167.95	0.85	35.28	0.012	47.45	0.845	173.93
2.6 GHz	0.956	167.26	0.82	33.39	0.013	48.18	0.847	173.45
2.7 GHz	0.955	166.56	0.79	31.53	0.014	48.80	0.848	172.94
2.8 GHz	0.954	165.84	0.77	29.68	0.014	49.32	0.849	172.43
2.9 GHz	0.953	165.10	0.75	27.86	0.015	49.74	0.850	171.89
3.0 GHz	0.952	164.34	0.73	26.04	0.016	50.05	0.851	171.33
3.2 GHz	0.950	162.75	0.70	22.46	0.018	50.40	0.852	170.17
3.4 GHz	0.948	161.07	0.68	18.91	0.020	50.38	0.852	168.93
3.6 GHz	0.944	159.27	0.66	15.37	0.023	50.02	0.852	167.61
3.8 GHz	0.941	157.33	0.65	11.82	0.025	49.32	0.850	166.19
4.0 GHz	0.936	155.23	0.64	8.23	0.029	48.30	0.848	164.68
4.2 GHz	0.931	152.94	0.64	4.57	0.033	46.94	0.844	163.06
4.4 GHz	0.925	150.43	0.64	0.80	0.037	45.24	0.840	161.32
4.6 GHz	0.917	147.66	0.65	-3.12	0.042	43.18	0.834	159.44
4.8 GHz	0.908	144.59	0.66	-7.23	0.048	40.72	0.826	157.41
5.0 GHz	0.896	141.14	0.68	-11.60	0.055	37.83	0.817	155.20
5.2 GHz	0.883	137.25	0.71	-16.29	0.064	34.45	0.805	152.81
5.4 GHz	0.866	132.84	0.74	-21.37	0.074	30.53	0.791	150.19
5.6 GHz	0.845	127.78	0.78	-26.94	0.086	25.97	0.774	147.33
5.8 GHz	0.820	121.95	0.83	-33.09	0.101	20.69	0.755	144.21
6.0 GHz	0.789	115.17	0.88	-39.95	0.118	14.58	0.731	140.79

To download the s-parameters in s2p format, go to the [CGH40120F Product Page](#) and click on the documentation tab.

Product Dimensions CGH40120F (Package Type – 440193)

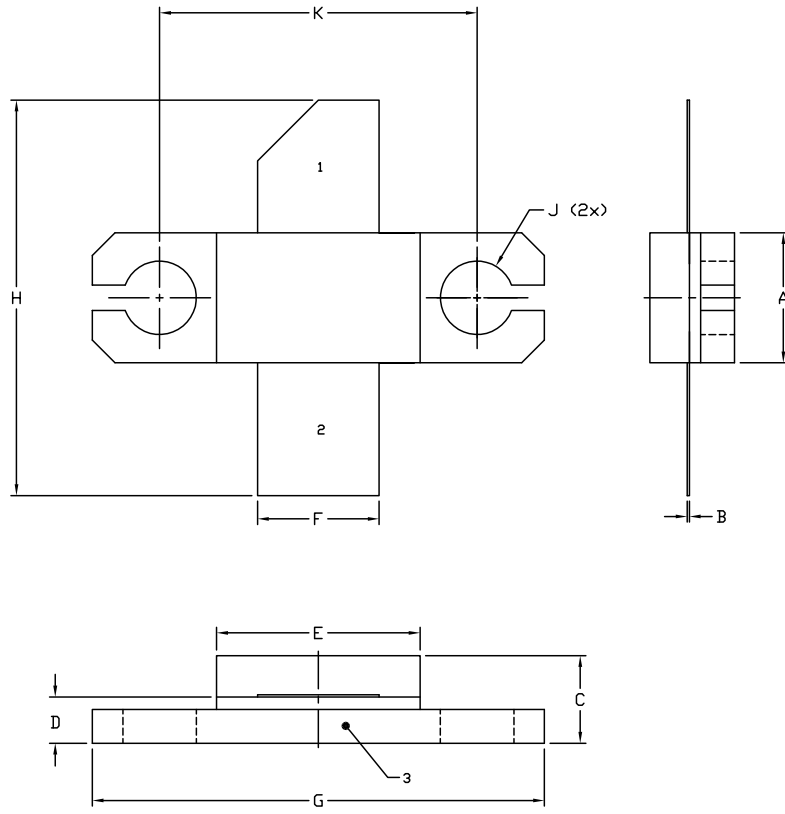

- NOTES:
1. DIMENSIONING AND TOLERANCING PER ANSI Y14.5M, 1982.
 2. CONTROLLING DIMENSION: INCH.
 3. ADHESIVE FROM LID MAY EXTEND A MAXIMUM OF 0.020" BEYOND EDGE OF LID.
 4. LID MAY BE MISALIGNED TO THE BODY OF THE PACKAGE BY A MAXIMUM OF 0.008" IN ANY DIRECTION.
 5. ALL PLATED SURFACES ARE Ni/AU.

DIM	INCHES		MILLIMETERS	
	MIN	MAX	MIN	MAX
A	0.225	0.235	5.72	5.97
B	0.004	0.006	0.10	0.15
C	0.145	0.165	3.68	4.19
D	0.077	0.087	1.96	2.21
E	0.355	0.365	9.02	9.27
F	0.210	0.220	5.33	5.59
G	0.795	0.805	20.19	20.45
H	0.670	0.730	17.02	18.54
J	Ø .130		3.30	
k	0.562		14.28	

- PIN 1. GATE
 PIN 2. DRAIN
 PIN 3. SOURCE

Product Ordering Information

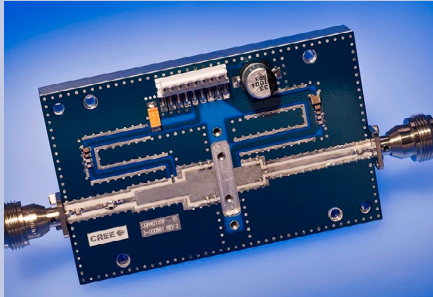
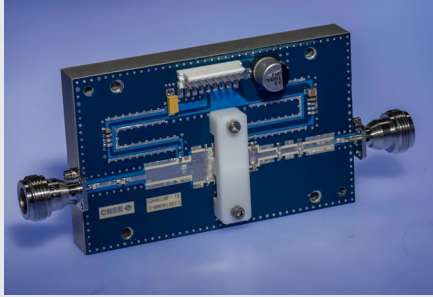
Order Number	Description	Unit of Measure	Image
CGH40120F	GaN HEMT	Each	
CGH40120F-TB	Test board without GaN HEMT	Each	
CGH40120F-AMP	Test board with GaN HEMT installed	Each	



Disclaimer

Specifications are subject to change without notice. Cree, Inc. believes the information contained within this data sheet to be accurate and reliable. However, no responsibility is assumed by Cree for any infringement of patents or other rights of third parties which may result from its use. No license is granted by implication or otherwise under any patent or patent rights of Cree. Cree makes no warranty, representation or guarantee regarding the suitability of its products for any particular purpose. "Typical" parameters are the average values expected by Cree in large quantities and are provided for information purposes only. These values can and do vary in different applications and actual performance can vary over time. All operating parameters should be validated by customer's technical experts for each application. Cree products are not designed, intended or authorized for use as components in applications intended for surgical implant into the body or to support or sustain life, in applications in which the failure of the Cree product could result in personal injury or death or in applications for planning, construction, maintenance or direct operation of a nuclear facility.

For more information, please contact:

Cree, Inc.
4600 Silicon Drive
Durham, North Carolina, USA 27703
www.cree.com/RF

Sarah Miller
Marketing
Cree, RF Components
1.919.407.5302

Ryan Baker
Marketing & Sales
Cree, RF Components
1.919.407.7816

Tom Dekker
Sales Director
Cree, RF Components
1.919.407.5639