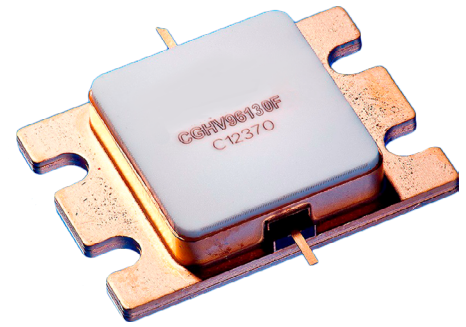


# CGHV96130F

130 W, 8.4 - 9.6 GHz, 50-ohm, Input/Output Matched GaN Amplifier



## Description

The CGHV96130F is a gallium nitride (GaN) amplifier. This GaN amplifier offers excellent power added efficiency in comparison to other technologies. GaN has superior properties compared to silicon or gallium arsenide, including higher breakdown voltage, higher saturated electron drift velocity and higher thermal conductivity. GaN HEMTs also offer greater power density and wider bandwidths compared to GaAs transistors. This amplifier is available in a metal/ceramic flanged package for optimal electrical and thermal performance.

Package Type: 440217  
PN: CGHV96130F

## Typical Performance Over 8.4 - 9.6 GHz ( $T_c = 25^\circ\text{C}$ )

Parameter	8.4 GHz	8.6 GHz	8.8 GHz	9.0 GHz	9.2 GHz	9.4 GHz	9.6 GHz	Units
Linear Gain	13.6	13.1	13.3	13.5	13.8	13.0	11.8	dB
Output Power	184	173	173	168	163	165	153	W
Power Gain	8.7	8.4	8.4	8.3	8.0	8.2	7.8	dB
Power Added Efficiency	36	33	33	33	34	38	39	%

Note:

Measured in CGHV96130F-AMP (838179) under 100  $\mu\text{s}$  pulse width, 10% duty,  $P_{IN}$  44.0 dBm (25.1 W)

### Features

- 8.4 - 9.6 GHz Operation
- 166 W  $P_{OUT}$  typical
- 7.5 dB Power Gain
- 42% Typical PAE
- 50 Ohm Internally Matched
- <0.3 dB Power Droop

### Applications

- Marine Radar
- Weather Monitoring
- Air Traffic Control
- Maritime Vessel Traffic Control
- Port Security

Large Signal Models Available for ADS and MWO



### Absolute Maximum Ratings (not simultaneous)

Parameter	Symbol	Rating	Units	Conditions
Drain-source Voltage	$V_{DSS}$	120	V	25°C
Gate-Source Voltage	$V_{GS}$	-10, +2		
Power Dissipation	$P_{DISS}$	222.0	W	Pulse
Storage Temperature	$T_{STG}$	-65, +150	°C	
Operating Junction Temperature	$T_J$	225		
DC Drain Current	$I_{DMAX}$	5.6	A	
Maximum Forward Gate Current	$I_{GMAX}$	28.8	mA	25°C
Soldering Temperature <sup>1</sup>	$T_S$	245	°C	
Screw Torque	$\tau$	40	in-oz	
Thermal Resistance, Junction to Case	$R_{\theta JC}$	0.73	°C/W	Pulse Width = 100 $\mu$ s, Duty Cycle = 10%, 85°C, $P_{DISS} = 173$ W
Case Operating Temperature <sup>2</sup>	$T_C$	-40, +150	°C	
Pulse Width	PW	100	$\mu$ sec	
Duty Cycle	DC	10	%	

Notes:

<sup>1</sup> Refer to the Application Note on soldering<sup>2</sup> See also, the Power Dissipation De-rating Curve on Page 9

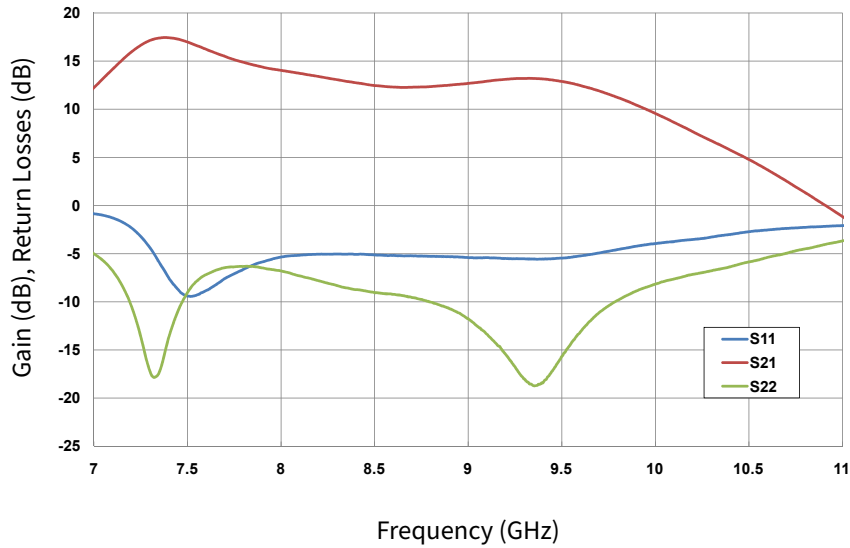
### Electrical Characteristics (Frequency = 9.4 GHz unless otherwise stated; $T_C = 25^\circ\text{C}$ )

Characteristics	Symbol	Min.	Typ.	Max.	Units	Conditions
<b>DC Characteristics<sup>1</sup></b>						
Gate Threshold Voltage	$V_{GS(th)}$	-3.8	-3.0	-2.3	V	$V_{DS} = 10$ V, $I_D = 28.8$ mA
Gate Quiescent Voltage	$V_{GS(Q)}$	–	-2.7	–		$V_{DS} = 40$ V, $I_D = 1000$ mA
Saturated Drain Current <sup>2</sup>	$I_{DS}$	21.0	26.0	–	A	$V_{DS} = 6.0$ V, $V_{GS} = 2.0$ V
Drain-Source Breakdown Voltage	$V_{BD}$	100	–	–	$V_{DC}$	$V_{GS} = -8$ V, $I_D = 28.8$ mA
<b>RF Characteristics<sup>3</sup></b>						
Small Signal Gain	S21	10.5	12.2	–	dB	$V_{DD} = 40$ V, $I_{DQ} = 1000$ mA, $P_{IN} = -20$ dBm
Input Return Loss at 8.4 - 9.4 GHz	S11	–	-5.4	–		
Input Return Loss at 9.4 - 9.6 GHz		–	-5.6	–		
Output Return Loss	S22	–	-8.8	–		
Power Output <sup>3,4</sup>	$P_{OUT}$	130	166	–	W	$V_{DD} = 40$ V, $I_{DQ} = 1000$ mA, $P_{IN} = 44$ dBm
Power Added Efficiency <sup>3,4</sup>	PAE	30	42	–	%	
Power Gain <sup>3,4</sup>	$P_G$	7.0	7.5	–	dB	
Output Mismatch Stress	VSWR	–	–	5:1	$\Psi$	No damage at all phase angles, $V_{DD} = 40$ V, $I_{DQ} = 1000$ mA

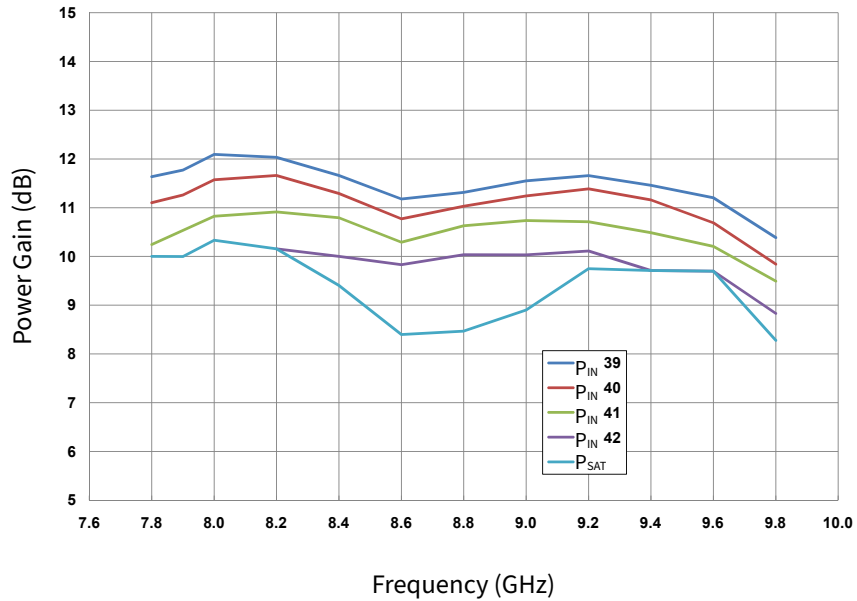
Notes:

<sup>1</sup> Measured on wafer prior to packaging<sup>2</sup> Scaled from PCM data<sup>3</sup> Measured in CGHV96100F2-TB (838179) under 100  $\mu$ s pulse width, 10% duty<sup>4</sup> Fixture loss de-embedded using the following offsets: Frequency = 9.4 GHz. Input = 0.5 dB and Output = 0.5 dB

**CGHV96130F Typical Performance**

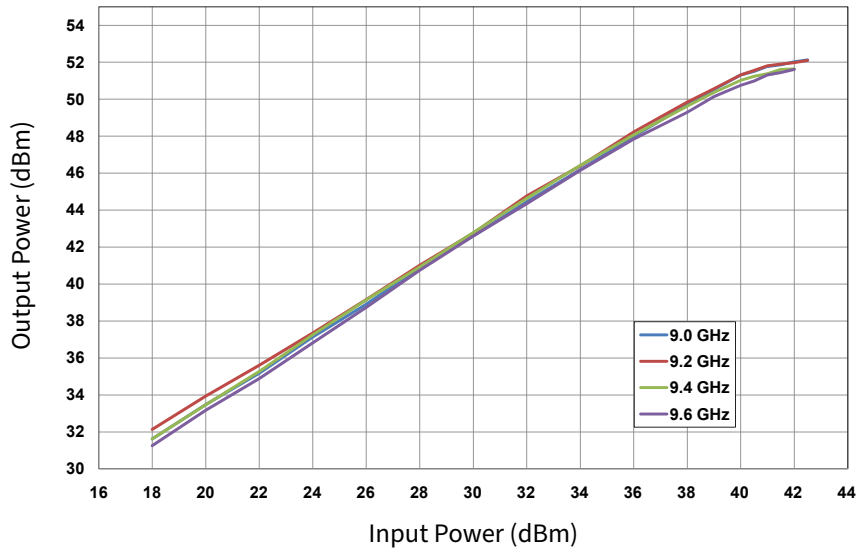


**Figure 1.** Small Signal Gain and Return Loss vs Frequency of CGHV96130F measured in CGHV96130F-AMP  
 $V_{DS} = 40\text{ V}$ ,  $I_{DQ} = 1000\text{mA}$

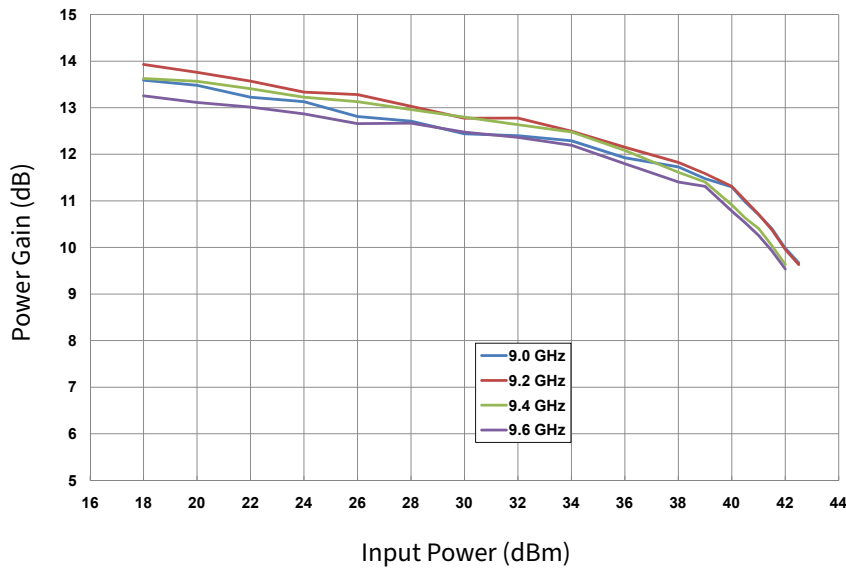


**Figure 2.** Power Gain vs. Frequency and Input Power  
 $V_{DD} = 40\text{ V}$ , Pulse Width = 100  $\mu\text{sec}$ , Duty Cycle = 10%

**CGHV96130F Typical Performance**

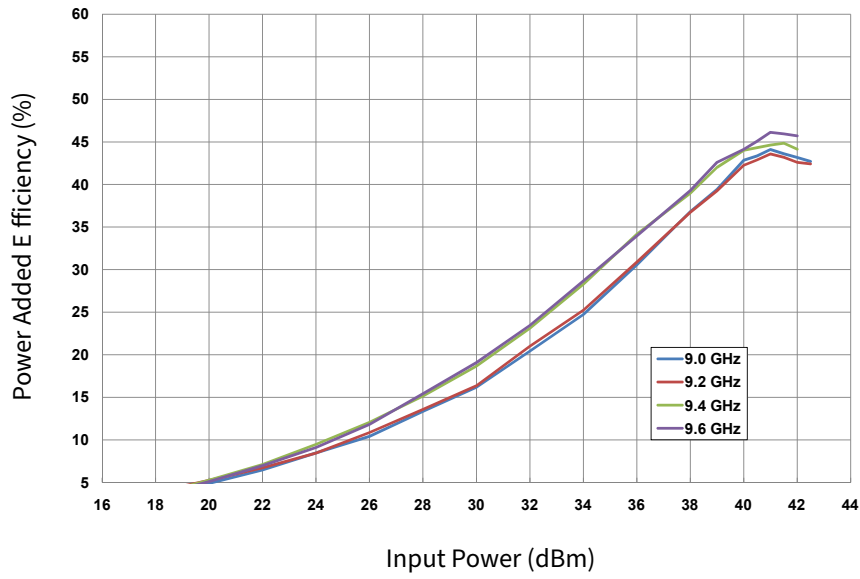


**Figure 3.** Output Power vs. Input Power  
 $V_{DD} = 40\text{ V}$ , Pulse Width = 100  $\mu\text{sec}$ , Duty Cycle = 10%

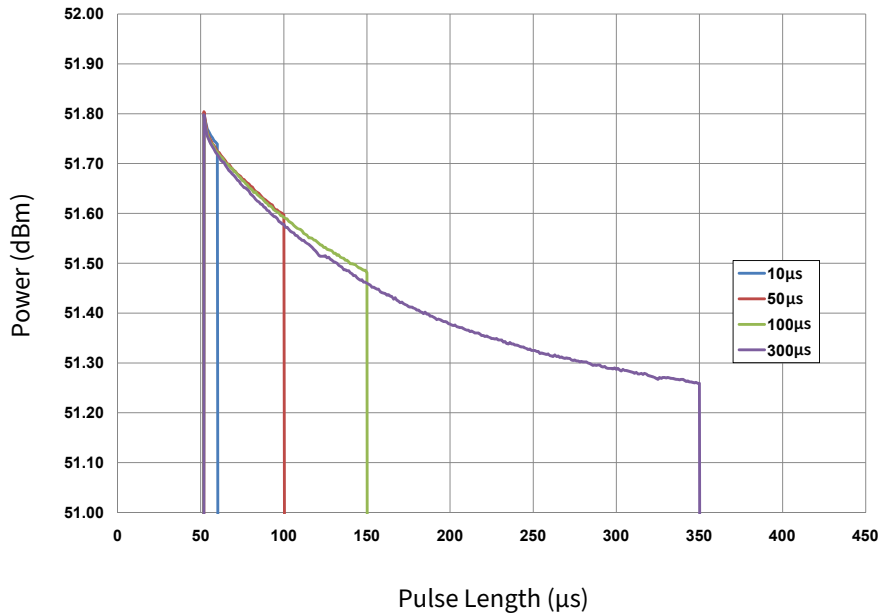


**Figure 4.** Power Gain vs. Frequency and Input Power  
 $V_{DD} = 40\text{ V}$ , Pulse Width = 100  $\mu\text{sec}$ , Duty Cycle = 10%

**CGHV96130F Typical Performance**

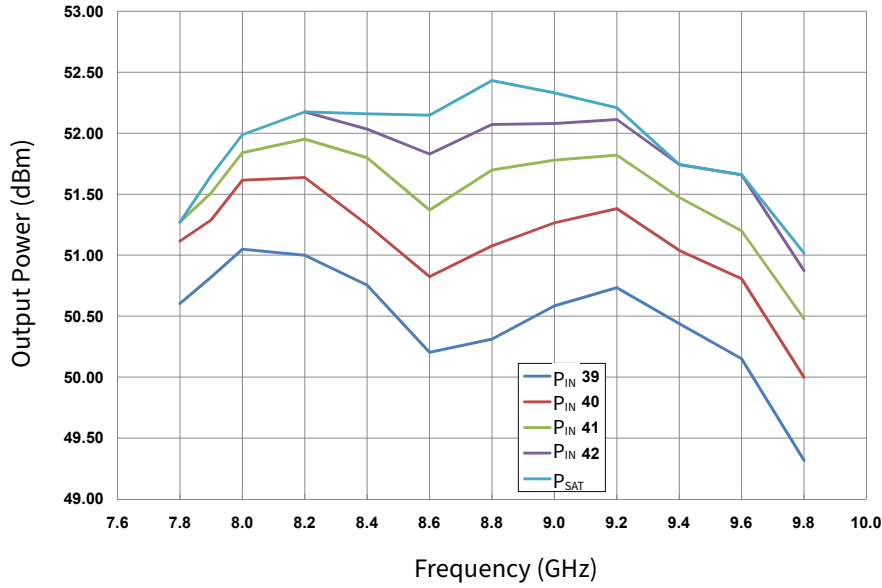


**Figure 5.** Power Added Efficiency vs. Input Power  
 $V_{DD} = 40\text{ V}$ , Pulse Width = 100  $\mu\text{sec}$ , Duty Cycle = 10%

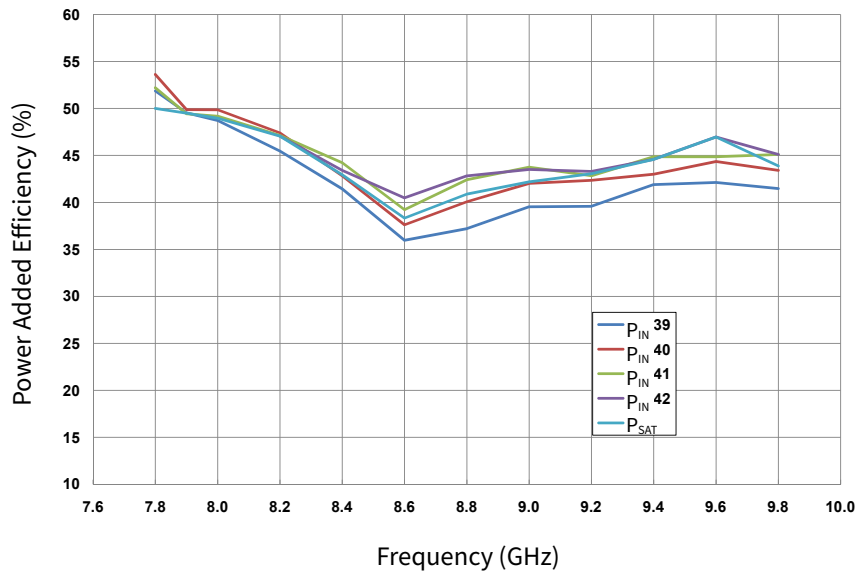


**Figure 6.** Output Power vs. Time  
 $V_{DD} = 40\text{ V}$ ,  $P_{IN} = 41\text{ dBm}$ , Duty Cycle = 10%

**CGHV96130F Typical Performance**



**Figure 7.** Output Power vs. Input Power & Frequency  
 $V_{DD} = 40\text{ V}$ , Pulse Width = 100  $\mu\text{sec}$ , Duty Cycle = 10%

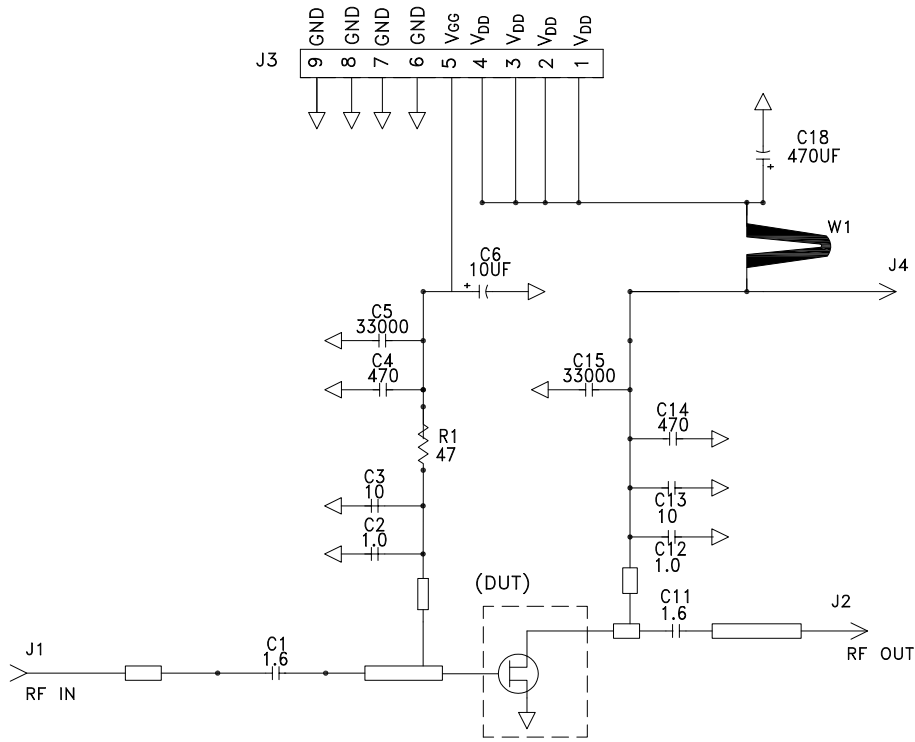


**Figure 8.** Power Added Efficiency vs. Input Power & Frequency  
 $V_{DD} = 40\text{ V}$ , Pulse Width = 100  $\mu\text{sec}$ , Duty Cycle = 10%

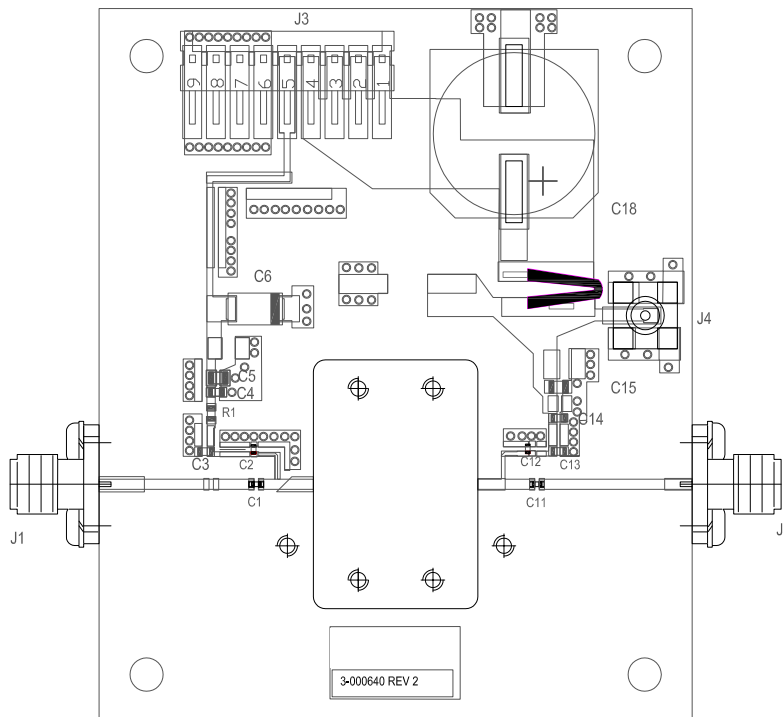
**CGHV96130F-AMP Demonstration Amplifier Circuit Bill of Materials**

<b>Designator</b>	<b>Description</b>	<b>Qty</b>
R1	RES, 47 OHM +/-1%, 1/16 W, 0603, SMD	1
C1, C11	CAP, 1.6pF, +/- 0.1pF, 200V, 0402, ATC 600L	2
C2, C12	CAP, 1.0pF, +/- 0.1pF, 200V, 0402 ATC 600L	2
C3, C13	CAP, 10pF +/-5%, 0603, ATC	2
C4, C14	CAP, 470pF +/-5%, 100 V, 0603	2
C5, C15	CAP, 33,000pF, 0805, 100 V, X7R	2
C6	CAP, 10μF, 16 V, TANTALUM	1
C18	CAP, 470μF +/-20%, ELECTROLYTIC	1
J1,J2	CONNECTOR, SMA, PANEL MOUNT JACK, FLANGE, 4-HOLE, BLUNT POST, 20MIL	2
J3	CONNECTOR, HEADER, RT>PLZ .1CEN LK 9POS	1
J4	CONNECTOR, SMB, STRAIGHT JACK	1
	PCB, TEST FIXTURE, TACONICS RF35P, 20 MIL THK, 440210 PKG	1
	2-56 SOC HD SCREW 1/4 SS	4
	#2 SPLIT LOCKWASHER SS	4
Q1	CGHV96130F	1

**CGHV96130F-AMP Demonstration Amplifier Circuit Schematic**

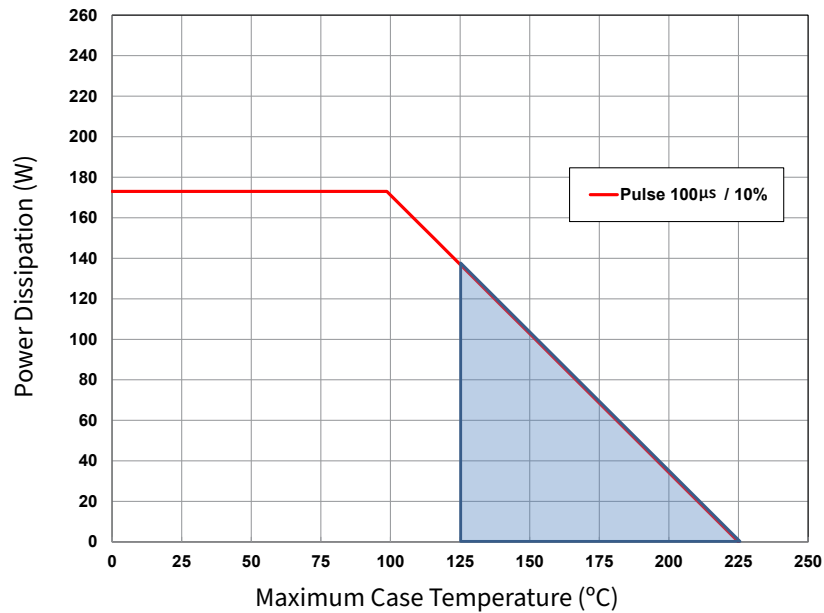


**CGHV96130F-AMP Demonstration Amplifier Circuit Outline**



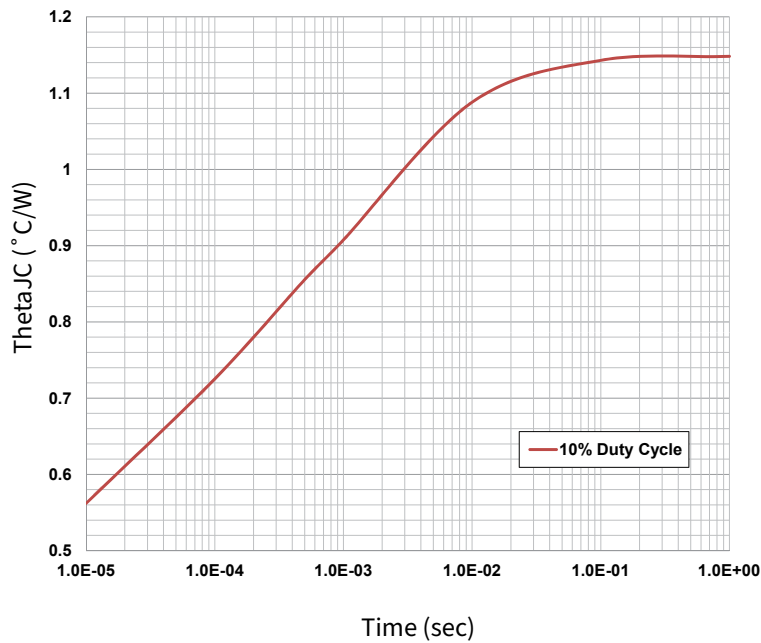


### CGHV96130F Power Dissipation De-rating Curve



Note:  
<sup>1</sup> Shaded area exceeds Maximum Case Operating Temperature (See Page 2)

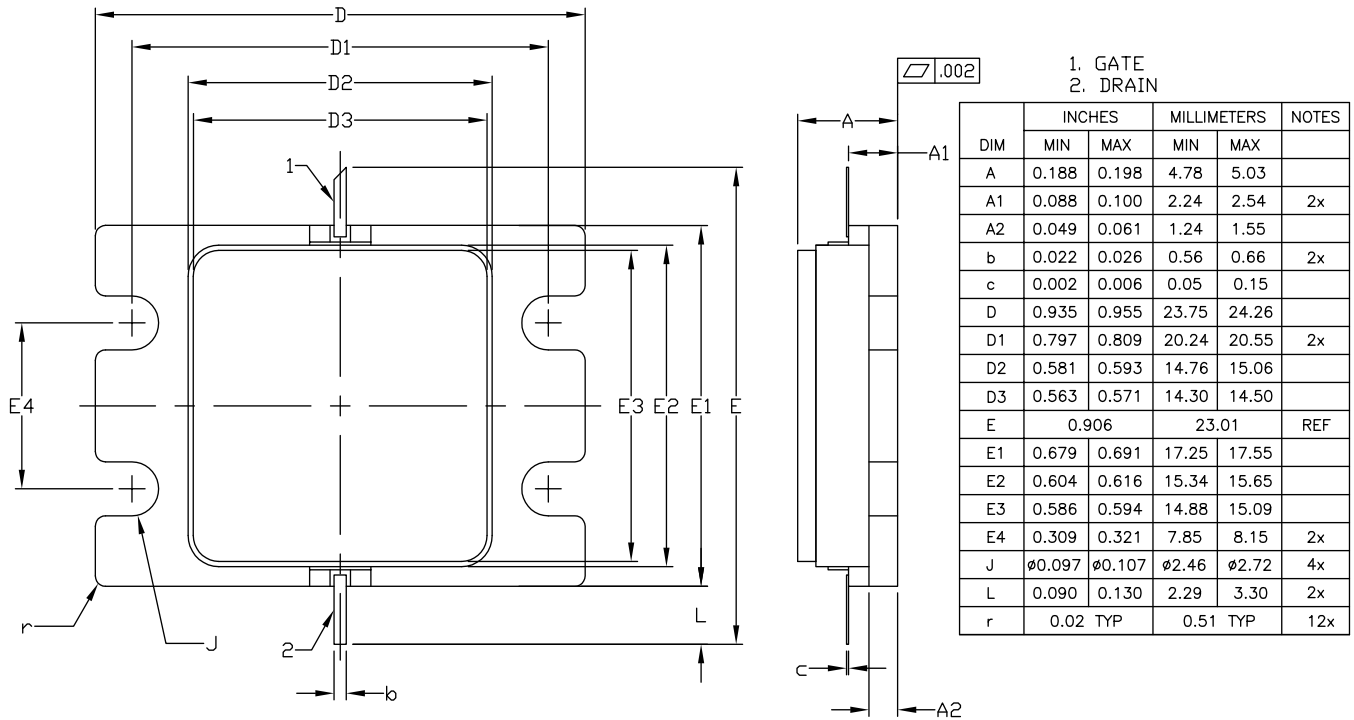
### CGHV96130F Transient Curve



### Electrostatic Discharge (ESD) Classifications

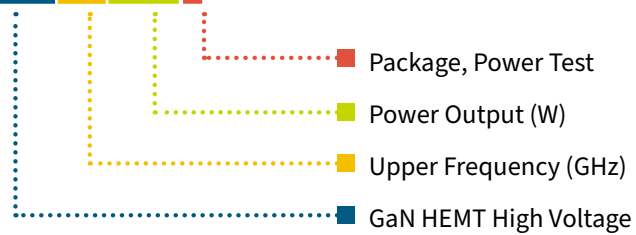
Parameter	Symbol	Class	Classification Level	Test Methodology
Human Body Model	HBM	TBD	ANSI/ESDA/JEDEC JS-001 Table 3	JEDEC JESD22 A114-D
Charge Device Model	CDM	TBD	ANSI/ESDA/JEDEC JS-002 Table 3	JEDEC JESD22 C101-C

**Product Dimensions CGHV96130F (Package Type — 440217)**



## Part Number System

### CGHV96130F



**Table 1.**

Parameter	Value	Units
Upper Frequency <sup>1</sup>	9.6	GHz
Power Output	130	W
Package	Flange	—

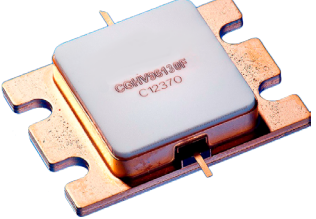
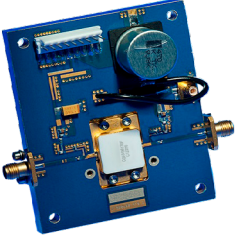
Note:

<sup>1</sup> Alpha characters used in frequency code indicate a value greater than 9.9 GHz. See Table 2 for value.

**Table 2.**

Character Code	Code Value
A	0
B	1
C	2
D	3
E	4
F	5
G	6
H	7
J	8
K	9
Examples	1A = 10.0 GHz 2H = 27.0 GHz

**Product Ordering Information**

Order Number	Description	Unit of Measure	Image
CGHV96130F	GaN HEMT	Each	
CGHV96130F-AMP	Test board with GaN HEMT	Each	

## Notes & Disclaimer

---

MACOM Technology Solutions Inc. ("MACOM"). All rights reserved.

These materials are provided in connection with MACOM's products as a service to its customers and may be used for informational purposes only. Except as provided in its Terms and Conditions of Sale or any separate agreement, MACOM assumes no liability or responsibility whatsoever, including for (i) errors or omissions in these materials; (ii) failure to update these materials; or (iii) conflicts or incompatibilities arising from future changes to specifications and product descriptions, which MACOM may make at any time, without notice. These materials grant no license, express or implied, to any intellectual property rights.

THESE MATERIALS ARE PROVIDED "AS IS" WITH NO WARRANTY OR LIABILITY, EXPRESS OR IMPLIED, RELATING TO SALE AND/OR USE OF MACOM PRODUCTS INCLUDING FITNESS FOR A PARTICULAR PURPOSE, MERCHANTABILITY, INFRINGEMENT OF INTELLECTUAL PROPERTY RIGHT, ACCURACY OR COMPLETENESS, OR SPECIAL, INDIRECT, INCIDENTAL, OR CONSEQUENTIAL DAMAGES WHICH MAY RESULT FROM USE OF THESE MATERIALS.

MACOM products are not intended for use in medical, lifesaving or life sustaining applications. MACOM customers using or selling MACOM products for use in such applications do so at their own risk and agree to fully indemnify MACOM for any damages resulting from such improper use or sale.