

# CGJ3E2C0G1H040C080AA

TDK Item Description : CGJ3E2C0G1H040CT\*\*\*



## Application & Main Feature

High Reliability Grade ( General (Up to 50V) )

## Series

CGJ3(1608) [EIA CC0603]

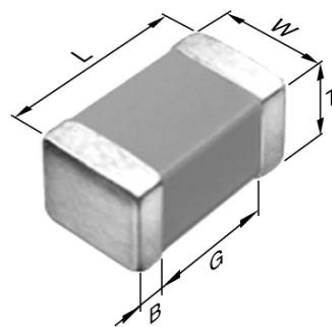

## Dimensions

L 1.60mm +/-0.1mm  
W 0.80mm +/-0.1mm  
T 0.80mm +/-0.1mm  
B 0.20mm Min.  
G 0.30mm Min.

## Temperature Characteristic

C0G (-55 to 125 degC 0+/-30ppm/degC)

## Rated Voltage

1H (50Vdc)

## Capacitance

4pF

## Capacitance Tolerance

C (+/-0.25pF)

## Q Factor

480 Min.

## Insulation Resistance

10Gohm Min.

## AEC-Q200

Yes

### |Z|, ESR vs. Freq. Characteristics

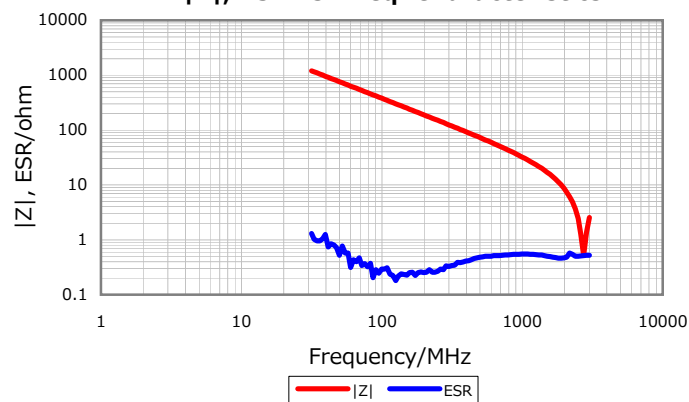

### DC Bias Characteristic

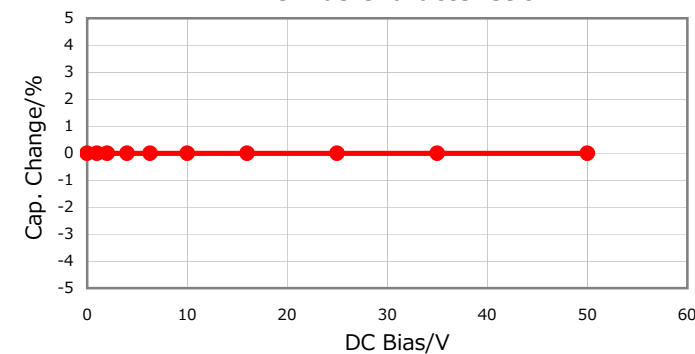

### Cap. vs. Freq. Characteristic

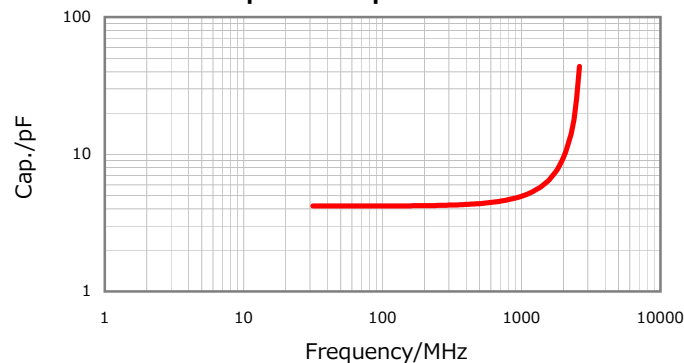

### Temperature Characteristics

