

# LITHIUM ION BATTERIES (INDIVIDUAL DATA SHEETS)

## CGR17670HC: Cylindrical Model

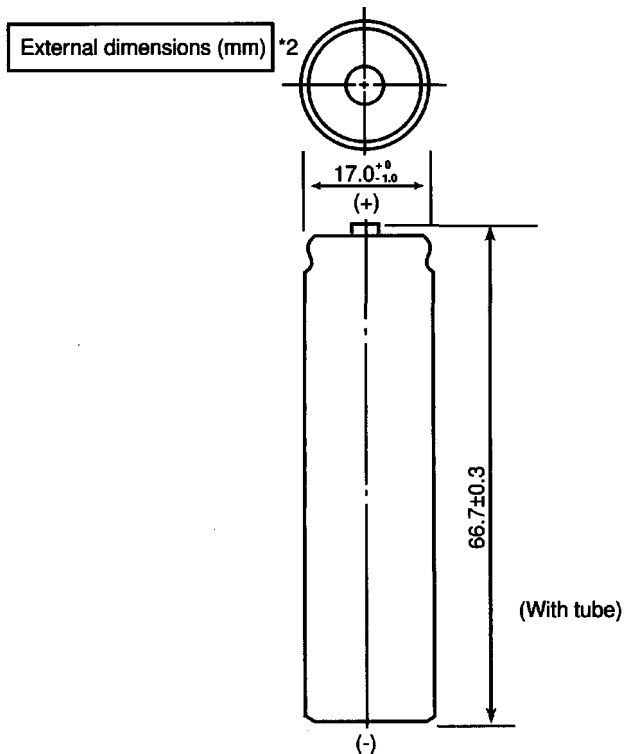

## Specifications

Nominal Voltage	3.7 V	
Standard Capacity * <sup>1</sup>	1250mAh	
Dimensions * <sup>2</sup>	Diameter	17.0 mm
	Height	66.7 ± 0.3 mm
	Weight	Approx. 35 g

\*1 After a fresh battery has been charged at constant voltage/constant current (4.2 V, 840 mA (max), 2 hours, 20°C), this is the average of the capacity (ending voltage of 3 V at 20°C) that is discharged at a standard current (240 mA).

\*2 Dimensions of a fresh battery

## Discharge Characteristics

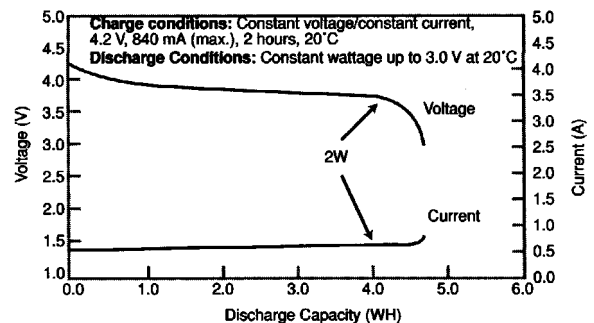
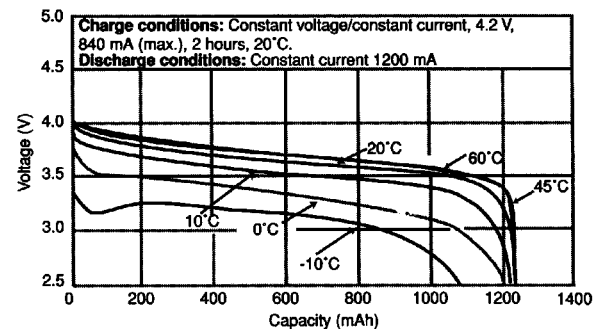
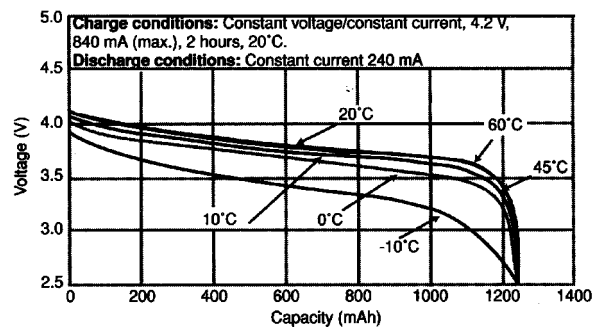
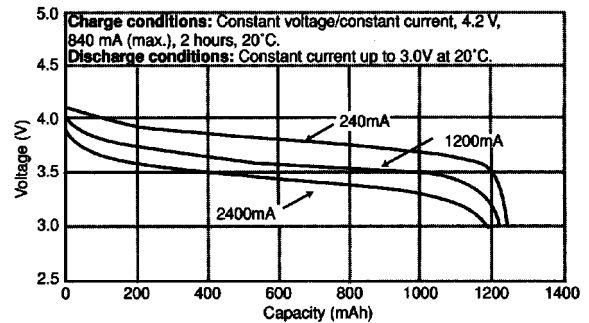

Discharge Characteristics

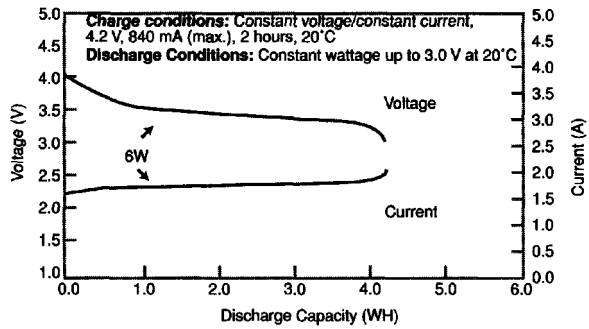
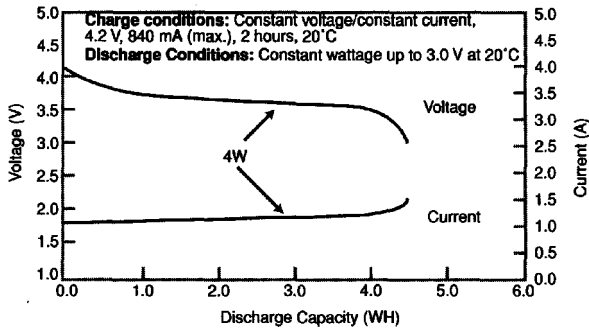

Storage Characteristics

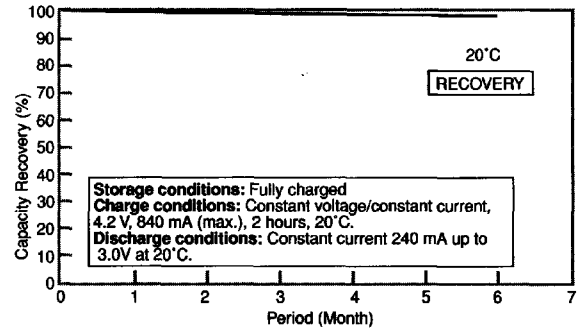
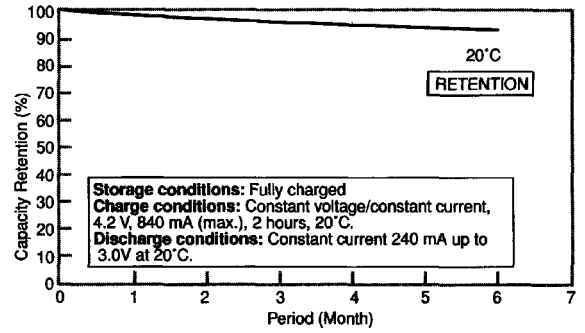

Charge Characteristics

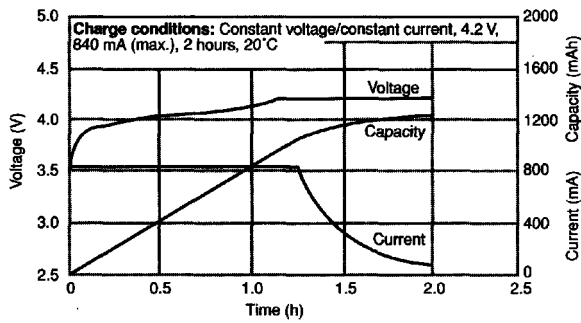

Cycle Life Characteristics

