

FEATURES

- Small Profile (3 x 3 x 1 mm)
- PFT™ 50 Ω Matched Module
- High Linearity of -50 dBc
- High PAE of 39%
- InGaP HBT Technology
- Low Quiescent Current of 55 mA
- Single Positive Supply Voltage

APPLICATIONS

- Korean PCS CDMA handsets

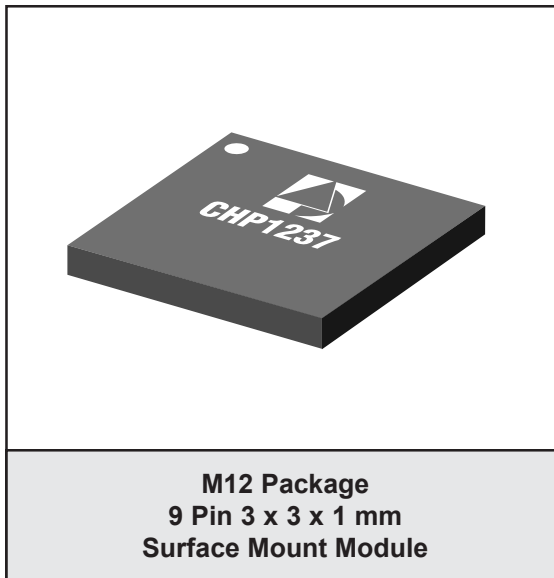

PRODUCT DESCRIPTION

CHP1237 is an InGaP HBT amplifier module offering high performance for PCS CDMA wireless handsets. It consists of a two-stage amplifier, 50 Ω matching network for both input and output, and a

bias control circuit. It is packaged in a 3 x 3 x 1 mm package using proprietary Passive-Free Technology (PFT)™. The package provides excellent electrical stability and low thermal resistance.

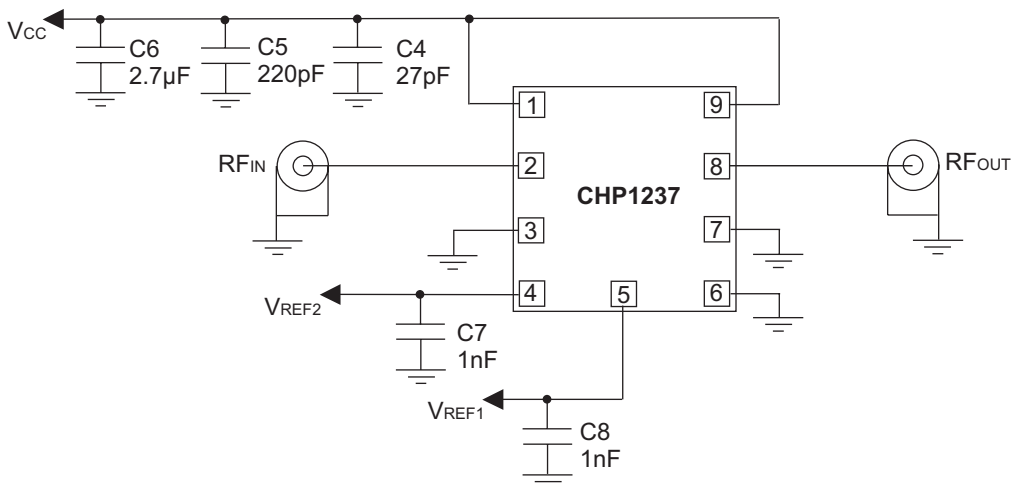

Figure 1: Block Diagram

Table 1: Pad Description

www.DataSheet4U.com

PIN	NAME	DESCRIPTION
1	V _{CC}	Supply Voltage
2	RF _{IN}	RF Input Signal
3	GND	Ground
4	V _{REF2}	Reference Voltage
5	V _{REF1}	Reference Voltage
6	GND	Ground
7	GND	Ground
8	RF _{OUT}	RF Output
9	V _{CC}	Supply Voltage

ELECTRICAL CHARACTERISTICS

Table 2: Absolute Minimum and Maximum Ratings www.DataSheet4U.com

PARAMETER	MIN	MAX	UNIT	COMMENTS
RF Input Power (P_{IN})	-	10	dBm	
Supply Voltage (V_{CC})	-	6	V	
Reference Voltage 1 (V_{REF1})	-	3.4	V	
Reference Voltage 2 (V_{REF2})	-	3.4	V	
Case Operating Temperature (T_C)	- 30	100	°C	
Storage Temperature (T_{STG})	- 55	125	°C	
Soldering Temperature (T_S)	-	240	°C	5 seconds

Stresses in excess of the absolute ratings may cause permanent damage. Functional operation is not implied under these conditions. Exposure to absolute ratings for extended periods of time may adversely affect reliability.

Table 3: Operating Ranges

PARAMETER	MIN	TYP	MAX	UNIT
Operating Frequency (f)	1750	-	1780	MHz
Supply Voltage (V_{CC})	+3.2	+3.4	+4.2	V
Reference Voltage 1 (V_{REF1})	+2.95	+3.00	+3.05	V
Reference Voltage 2 (V_{REF2})	+2.95	+3.00	+3.05	V
Operating Temperature (T_C)	-30	+25	+85	°C

The device may be operated safely over these conditions; however, parametric performance is guaranteed only over the conditions defined in the electrical specifications.

Table 4: Electrical Specifications
 (T_c = +25 °C, f_o = 1765 MHz, V_{CC} = 3.4 V, V_{REF1} = 3.0 V, V_{REF2} = 3.0 V, (unless otherwise specified)) www.DataSheet4U.com

PARAMETER	MIN	TYP	MAX	UNIT	COMMENTS
Gain G Gh	24 25.5	26.5 27.5	28 29.5	dB	P _O = 16 dBm P _O = 28 dBm
Gain Variation	-	-	1.0	dB	P _O = 28 dBm over frequency
Power-Added Efficiency ⁽¹⁾ PAE PAEH	7.5 36	9 39	- -	%	P _O = 16 dBm P _O = 28 dBm
Total Current (I)	- -	- -	157 515	mA	P _O = 16 dBm P _O = 28 dBm
Adjacent Channel Power Ratio ⁽²⁾ 1.25 MHz offset ACPR1L ACPR1H 2.25 MHz Offset ACPR2L ACPR2H	- - - -	-52 -50 -72 -59	-49 -47 -60 -56	dBc	P _O = 16 dBm P _O = 28 dBm P _O = 16 dBm P _O = 28 dBm
Quiescent Current I _{qs} (Shutdown Mode) I _q ⁽³⁾	- 45	1 55	5 60	μA mA	V _{REF1} = 0 V, V _{REF2} = 0 V, No RF V _{REF1} = 3 V, V _{REF2} = 3 V, No RF
Noise in Receive Band ⁽⁴⁾	-	-136	-133	dBm/Hz	P _O = 28 dBm
Harmonics 2f _o 3f _o	- -	- -	-30 -30	dBc	P _O = 28 dBm P _O = 28 dBm
Spurious Output Level	-	-	-60	dBc	VSWR < 6:1
Ruggedness - no damage ⁽⁵⁾	10:1	-	-	VSWR	P _O = 28 dBm

Notes:

- (1) Includes the current at pins 1, 4, 5, and 9.
- (2) ACPR is specified per IS95 as the ratio of adjacent power in 30 kHz BW to the total in-band power (1.23 MHz BW).
- (3) Includes the current at pins 1 and 9 (V_{CC} current).
- (4) RxBn is measured at 80 MHz above the operating frequency (F_o).
(Measurement setup: RBW = 30 kHz, VBW = 30 kHz).
- (5) All phases, time equals to 10 seconds.

Table 5: Power Mode Truth Table

POWER MODE	V _{REF1}	V _{REF2}	TYPICAL GAIN
Shut Down	0 V	0 V	<-40 dB
High Power	3 V	3 V	27.5 dB

PERFORMANCE DATA

Figure 2: ACP1_U vs Po
 ($V_{CC} = 3.4\text{ V}$, $V_{REF1} = 3.0\text{ V}$, $V_{REF2} = 3.0\text{ V}$, $F = 1.765\text{ GHz}$)

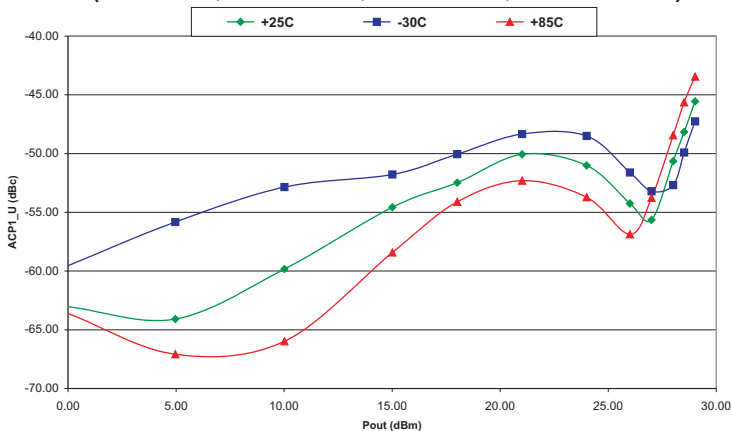

Figure 3: ACP2_U vs Po
 ($V_{CC} = 3.4\text{ V}$, $V_{REF1} = 3.0\text{ V}$, $V_{REF2} = 3.0\text{ V}$, $F = 1.765\text{ GHz}$)

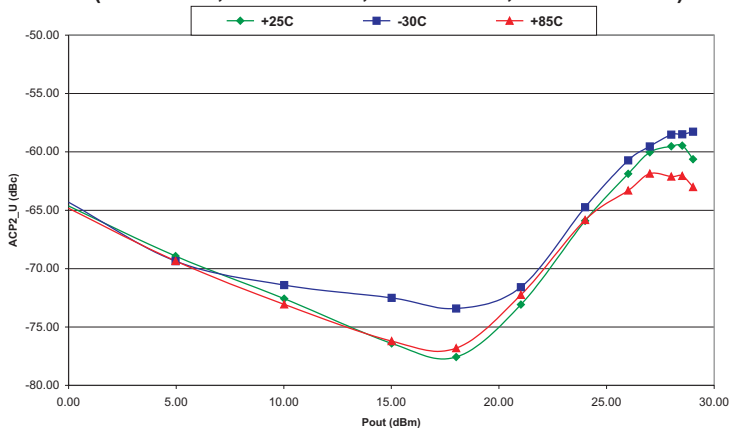

Figure 4: PAE vs Po
 ($V_{CC} = 3.4\text{ V}$, $V_{REF1} = 3.0\text{ V}$, $V_{REF2} = 3.0\text{ V}$, $F = 1.765\text{ GHz}$)

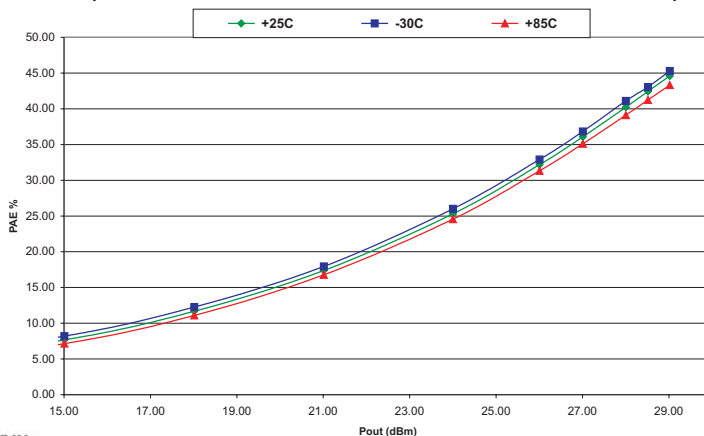

Figure 5: ACP1_U vs V_{CC}
 (P_o = 28 dBm, V_{REF1} = 3.0 V, V_{REF2} = 3.0 V)

www.DataSheet4U.com

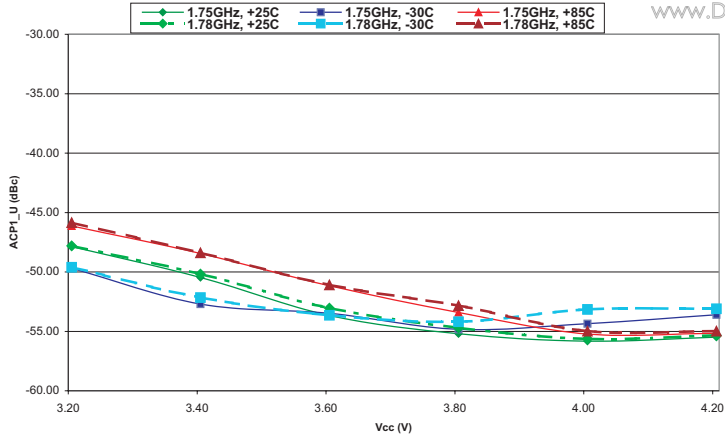

Figure 6: ACP2_U vs V_{CC}
 (P_o = 28 dBm, V_{REF1} = 3.0 V, V_{REF2} = 3.0 V)

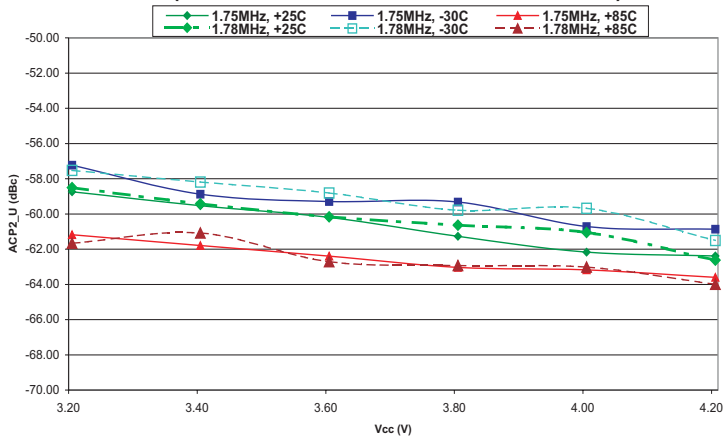

Figure 7: PAE vs V_{CC}
 (P_o = 28 dBm, V_{REF1} = 3.0 V, V_{REF2} = 3.0 V)

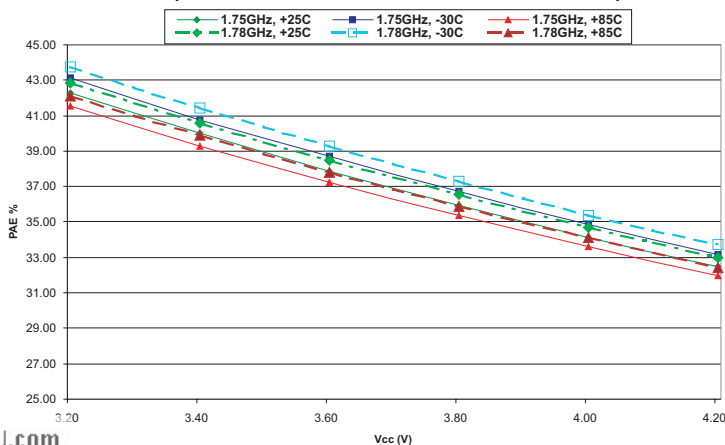

Figure 8: Gain vs P_{OUT}
 (V_{CC} = 3.4 V, V_{REF1} = 3.0 V, F = 1.765 GHz)

www.DataSheet4U.com

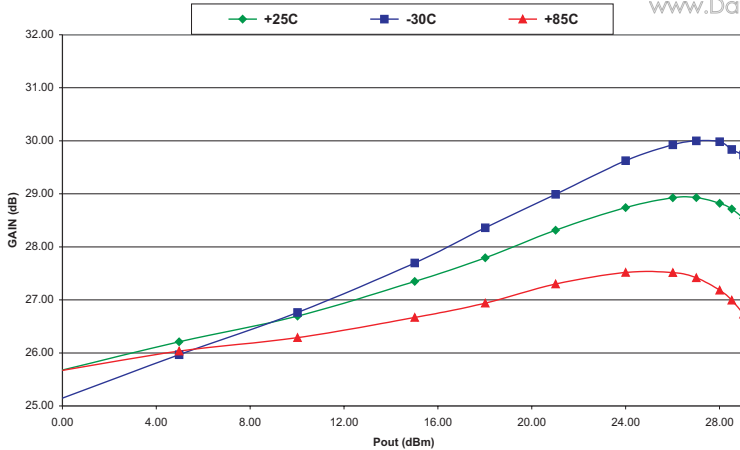
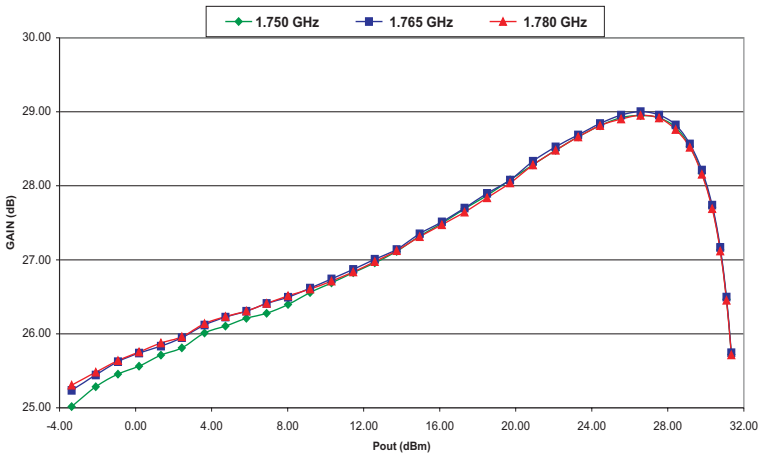
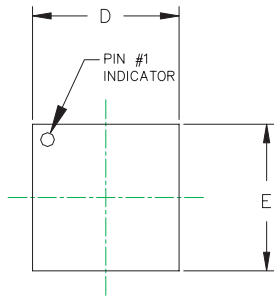

Figure 9: Gain vs P_{OUT}
 (V_{CC} = 3.4 V, V_{REF1} = 3.0 V)



PACKAGE OUTLINES



TOP VIEW

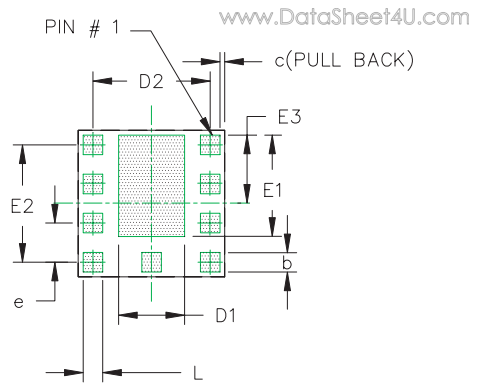

BOTTOM VIEW

SYMBOL	MILLIMETER			INCHES		
	MIN	NOM.	MAX	MIN	NOM.	MAX
A	0.90	1.00	1.10	0.035	0.039	0.043
A1	0.45	0.50	0.55	0.018	0.020	0.022
b	0.40	0.47	0.55	0.016	0.019	0.022
c	-	0.10	-	-	0.004	-
D	2.90	3.00	3.10	0.114	0.118	0.122
D1	-	1.35	-	-	0.053	-
D2	-	2.40	-	-	0.094	-
E	2.90	3.00	3.10	0.114	0.118	0.122
E1	-	2.07	-	-	0.081	-
E2	-	2.40	-	-	0.094	-
E3	-	1.40	-	-	0.055	-
e	0.80 BSC			0.031 BSC		
L	0.40	0.47	0.55	0.016	0.019	0.022

NOTES :

1. CONTROLLING DIMENSIONS ARE IN MILLIMETERS
2. UNLESS SPECIFIED TOLERANCE= $\pm 0.076[\pm 0.003]$.

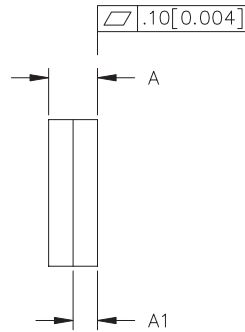

SIDE VIEW

Figure 10: Package Outline

NOTES

www.DataSheet4U.com

NOTES

www.DataSheet4U.com

**ANADIGICS, Inc.**

141 Mount Bethel Road
Warren, New Jersey 07059, U.S.A.

Tel: +1 (908) 668-5000

Fax: +1 (908) 668-5132

URL: <http://www.anadigics.com>

E-mail: Mktg@anadigics.com

IMPORTANT NOTICE

ANADIGICS, Inc. reserves the right to make changes to its products or to discontinue any product at any time without notice. The product specifications contained in Advanced Product Information sheets and Preliminary Data Sheets are subject to change prior to a product's formal introduction. Information in Data Sheets have been carefully checked and are assumed to be reliable; however, ANADIGICS assumes no responsibilities for inaccuracies. ANADIGICS strongly urges customers to verify that the information they are using is current before placing orders.

WARNING

ANADIGICS products are not intended for use in life support appliances, devices or systems. Use of an ANADIGICS product in any such application without written consent is prohibited.

www.DataSheet4U.com