

6-18GHz Phase-shifter

GaAs Monolithic Microwave IC

Description

The CHP4511 is a 4-bit digital phase-shifter with an output single pole double through (SPDT) switch. It is designed for 6 to 18GHz frequency range applications. The backside of the chip is both RF and DC grounded.

The circuit is manufactured with a Power pHEMT process, 0.25 μ m gate length, via holes through the substrate, air bridges and electron beam gate lithography.

It is available in chip form.

Main Features

- Broadband performances : 6-18GHz
- 22.5° phase step
- Losses < 15dB
- 22dBm input power at -1dBc
- I/O reversible.
- Adaptative SPDT
- 0/-5V control voltage
- Chip size: 4.62 x 3.0 x 0.1mm

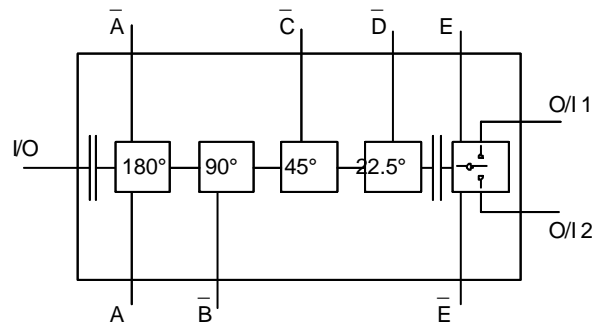

Typical on wafer measurements

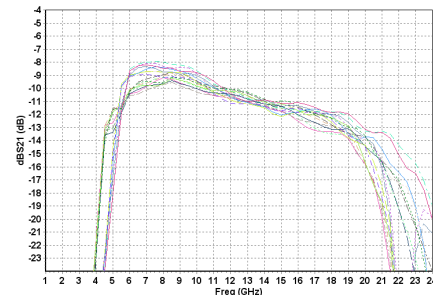

dB(S21) for 16 states

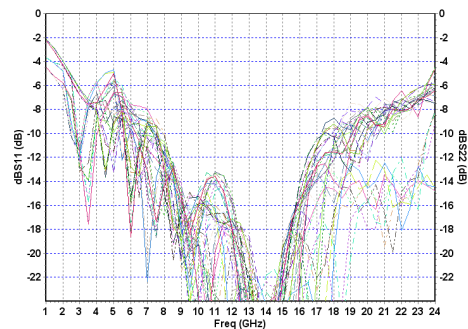

dB(S11) and dB(S22) for 16

Main Characteristics

Tamb. = 25°C

Symbol	Parameter	Min	Typ	Max	Unit
Fop	Operating frequency range	6		18	GHz
G	Small signal gain	-15		-7	dB
Poi1	Output power at 1dB compression		10		dBm
Vctrl	Voltage control	-5		0	V

ESD Protection: Electrostatic discharge sensitive device. Observe handling precautions !

Electrical Characteristics

Low level control voltage = -5V, High level control voltage = 0V

Pin = 5dBm on the input, output on SPDT 1 or 2

Tamb = +25°C

	Parameter	Conditions	Min	typ.	Max	Unit
Fop	Operating frequency range		6		18	GHz
Phrange	Phase shifter range		0	to	360	deg.
Phstep	Phase step			22.5		deg
S11	Input reflection coefficient				-6	dB
S22	Output reflection coefficient				-7	dB
S22off	Output reflection coefficient path OFF				-15	dB
IL	Insertion loss	6 to 14GHz 15 to 18GHz			13 15	dB
ISO	Isolation between Output 1 and 2		25	35		dB
AV	Amplitude variation			-1.5 / +2.5		dB
Pio1dB	Output Power @1dB compression	In => out1 or 2		10		dBm
Poi1dB	Output Power @1dB compression	out1 or 2 => in		12		dBm

	Parameter	Conditions	average	std dev	pk to pk	Unit
PPE	Peak Phase Error	state 22.5° state 45° state 90° state 180°	22.5° ±5 45° ±5 90° ±5 180° ±10	< 3° < 6° < 6° < 6°	±6° / average ±10° / average ±10° / average ±10° / average	deg

Peak Phase Error (PPE) definition:

$$PPE_{(i)} = \text{measured_phase}(S21)_{(i)} - \text{measured_phase}(S21)_{(0)} - \text{theoretical_phase}_{(i)}$$

(20 = state ∈ [0,15])

Amplitude variation (AV) definition:

$$AV_{(i)} = \text{measured_dB}(S21)_{(i)} - \text{measured_dB}(S21)_{(0)} \quad (i) = \text{state} \in [0,15]$$

Absolute Maximum Ratings

Tamb = +25°C

Operation of this device above anyone of these paramaters may cause permanent damage.

Symbol	Parameter	Values	Unit
Vgi	Phase shifter control voltage	-7 to +0.6	V
Pin	Maximum peak input power overdrive (1)	+30	dBm
Top	Operating temperature range	-40 to +70	°C
Tstg	Storage temperature range	-55 to +125	°C

(2) duration < 1s.

Phase Shifter Control Interface

The 4-bit phase shifter is controlled by 5 voltages:

State	TOTAL PHASE SHIFT	\bar{D} 25°	\bar{C} 45°	\bar{B} 90°	A 180°	\bar{A} 180°
0	0°	0	0	0	-5V	0
1	22.5°	-5V	0	0	-5V	0
2	45°	0	-5V	0	-5V	0
3	67.5°	-5V	-5V	0	-5V	0
4	90°	0	0	-5V	-5V	0
5	112.5°	-5V	0	-5V	-5V	0
6	135°	0	-5V	-5V	-5V	0
7	157.5°	-5V	-5V	-5V	-5V	0
8	180°	0	0	0	0	-5V
9	202.5°	-5V	0	0	0	-5V
10	225°	0	-5V	0	0	-5V
11	247.5°	-5V	-5V	0	0	-5V
12	270°	0	0	-5V	0	-5V
13	292.5°	-5V	0	-5V	0	-5V
14	315°	0	-5V	-5V	0	-5V
15	337.5°	-5V	-5V	-5V	0	-5V

The SPDT switch allows to choice one of the output path:

SPDT Control		Output Selected
E	\bar{E}	
0	-5V	O/I 1
-5V	0	O/I 2

Typical on wafer [S] measurements at +25°C

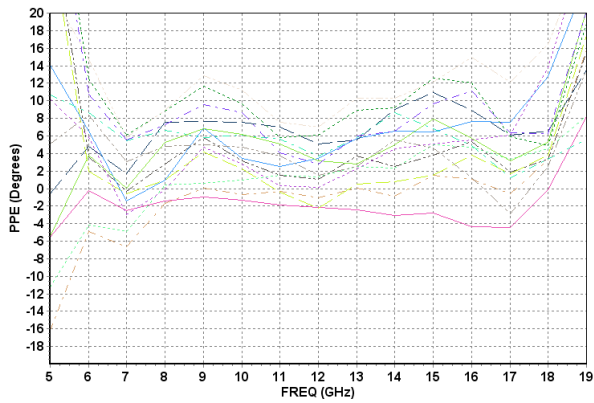

Peak phase error versus frequency for all states

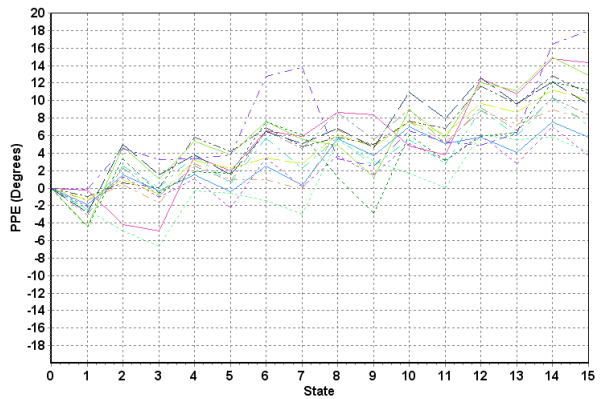

Peak phase error versus states
6GHz < frequency < 18GHz

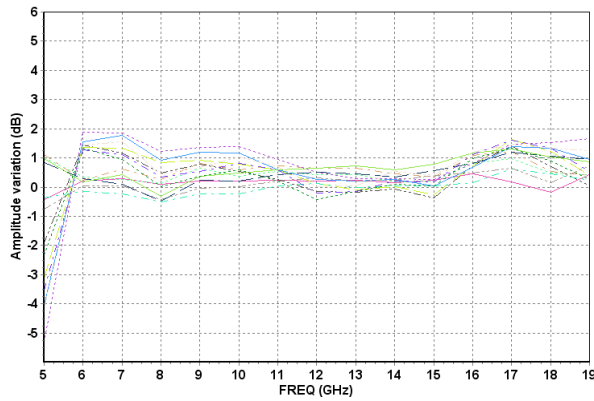

Amplitude variation versus frequency for all states

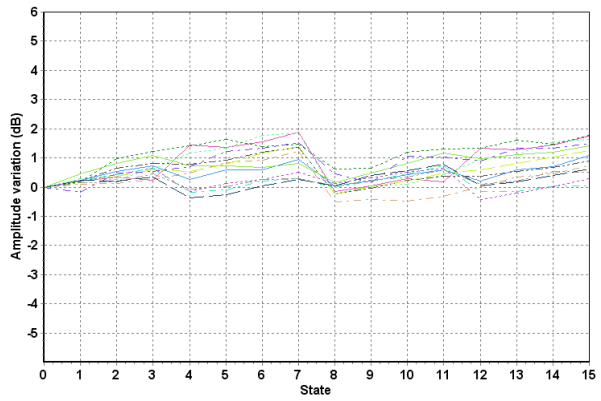

Amplitude variation versus states
6GHz < frequency < 18GHz

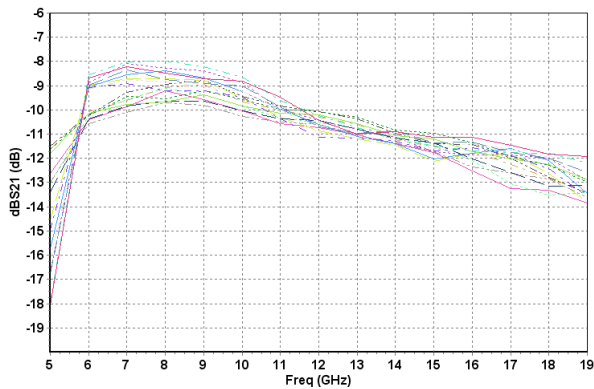

dB(S21) versus frequency for all states

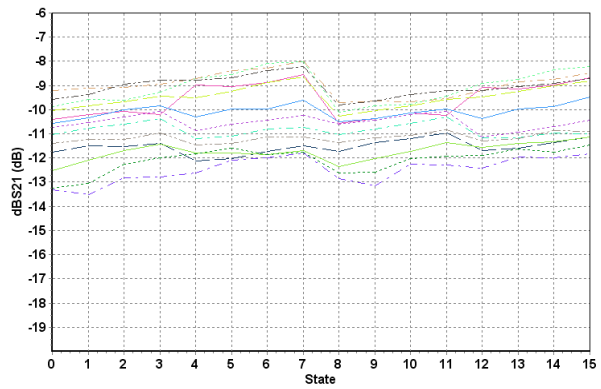

dB(S21) versus states
6GHz < frequency < 18GHz

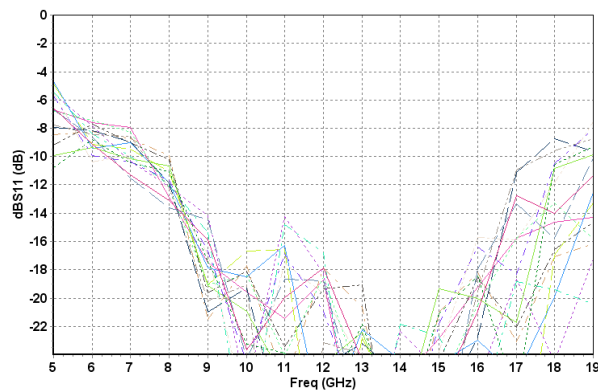

dB(S11) versus frequency for all states

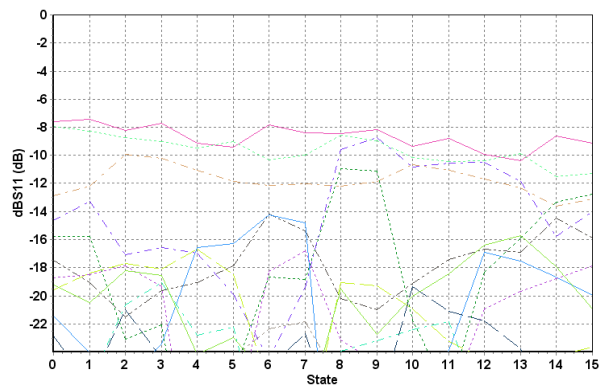

dB(S11) versus states
6GHz < frequency < 18GHz

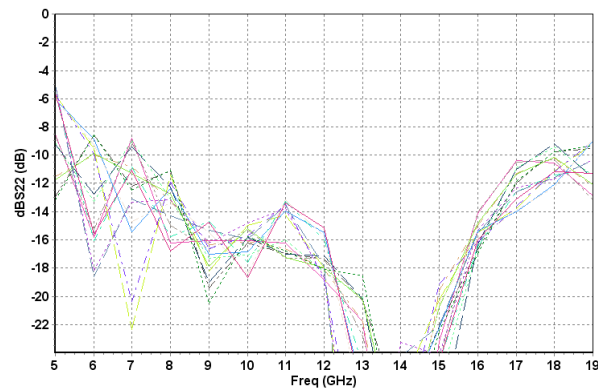

dB(S22) versus frequency for all states

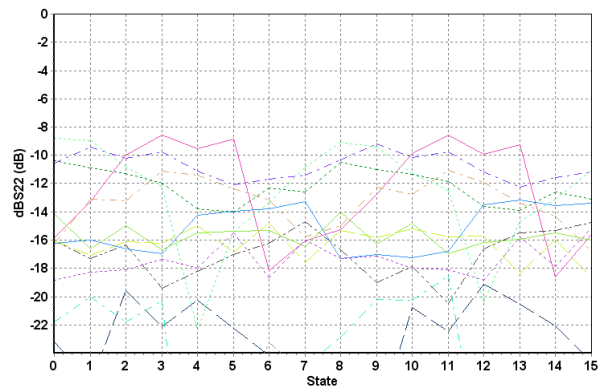

dB(S22) versus states
6GHz < frequency < 18GHz

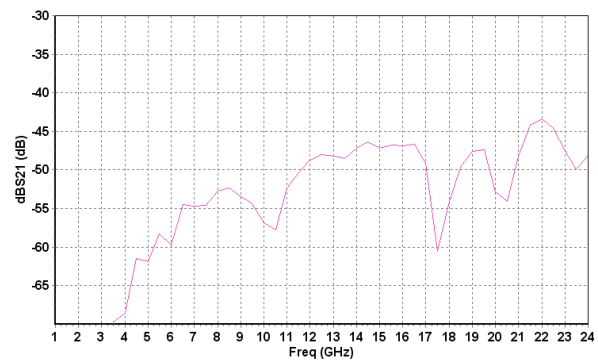

dB(S21) for path OFF: in => out1, state 0

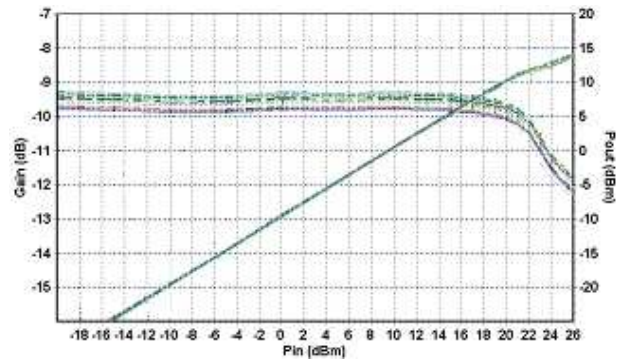

Gain and output power at 12GHz (input to output1)
(20 samples)

Chip Assembly and Mechanical Data

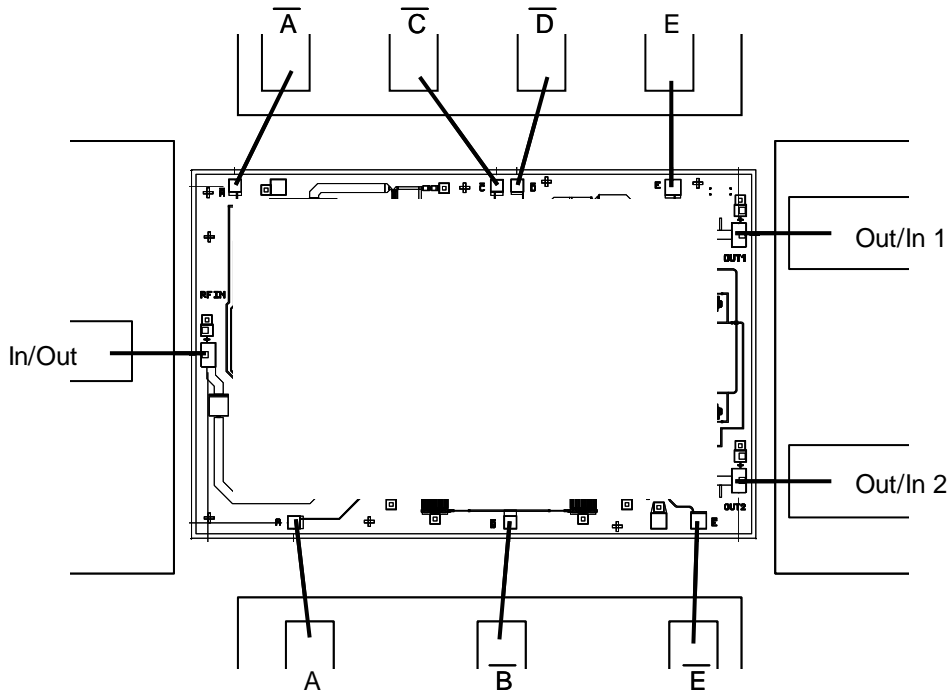

Note: 25µm diameter gold wire is recommended

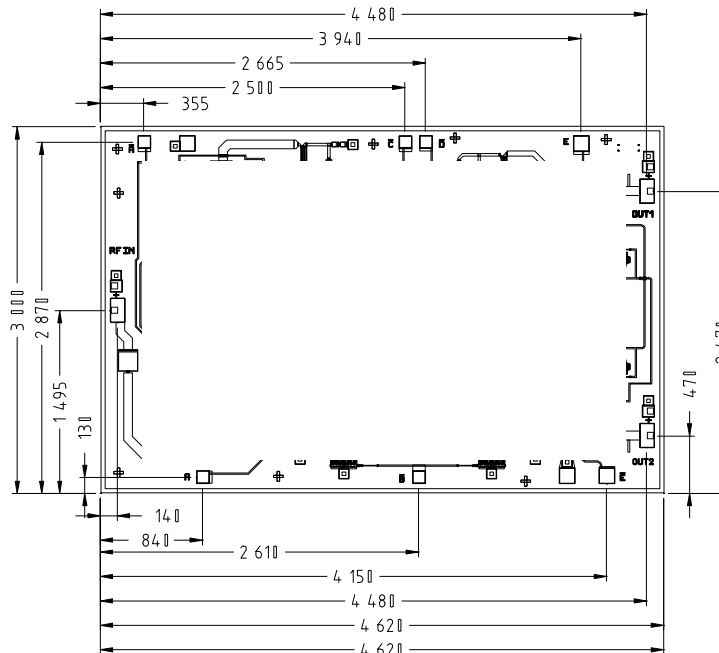

UNITS : µm
Tol : ±35µm

Bonding pad positions.
(Chip thickness: 100µm.all dimensions are in micrometers)

Notes

Ordering Information

Chip form : CHP4511-99F

Electronica S.p.A has the intellectual property of this MMIC and gives to **United Monolithic Semiconductors S.A.S.** non-exclusive license to sell it.

Information furnished is believed to be accurate and reliable. However **United Monolithic Semiconductors S.A.S.** assumes no responsibility for the consequences of use of such information nor for any infringement of patents or other rights of third parties which may result from its use. No license is granted by implication or otherwise under any patent or patent rights of **United Monolithic Semiconductors S.A.S.**. Specifications mentioned in this publication are subject to change without notice. This publication supersedes and replaces all information previously supplied. **United Monolithic Semiconductors S.A.S.** products are not authorised for use as critical components in life support devices or systems without express written approval from **United Monolithic Semiconductors S.A.S.**