

DC-35GHz 4 Bit Digital Attenuator

GaAs Monolithic Microwave IC

Description

The CHT3029-99F is a very wide band digital attenuator, which integrates 4 bits with a LSB of 1dB and provides a dynamic range of 15dB from DC to 35GHz.

It is designed for a wide range of applications, from military to commercial communication systems.

The circuit is manufactured with a pHEMT process, 0.25 μ m gate length, via holes through the substrate, air bridges and electron beam gate lithography.

It is available in chip form.

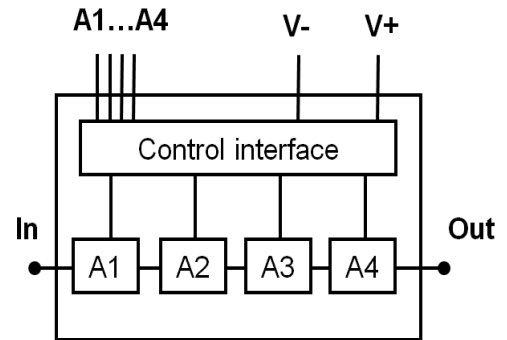

Main Features

- Broadband performances: DC-35GHz
- Insertion Loss (state 0): 4.5dB
- RMS attenuation error: 0.2dB
- Return Losses: 12dB
- DC bias: V+=5V and V-=-5V
- No internal DC Block at Input and Output RF accesses
- Chip size 2.61 x 1.56mm²

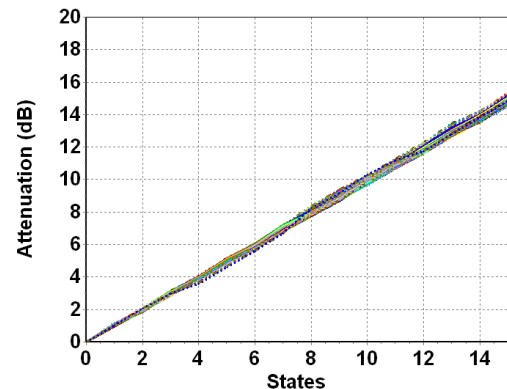

Main Electrical Characteristics

T_{amb.} = +25°C

Symbol	Parameter	Min	Typ	Max	Unit
Freq	Frequency range	DC		35	GHz
IL	Insertion Loss		4.5		dB
Rms_att_er	RMS of attenuation error		0.2		dB
Dyn	Dynamic		15		dB

Electrical Characteristics

Tamb.= +25°C, V+ = +5V V- = -5V

Symbol	Parameter	Min	Typ	Max	Unit
Freq	Frequency range	DC		35	GHz
IL	Insertion Loss		4.5		dB
S11	Input Return Loss		12		dB
S22	Output Return Loss		14		dB
IP1dB	Input power at 1dB gain compression		20		dBm
Dyn	Dynamic		15		dB
LSB	Attenuator elementary step		1		dB
Att_err	Attenuation error		±0.5		dB
Rms_att_err	RMS attenuation error		0.2		dB
Phivar	Phase variation		-5/+20		°
Rms_phi var	RMS phase variation		12		°
Sw_t	Switching time		15		ns
V+	Positive supply voltage		5		V
V-	Negative supply voltage		-5		V
Vctrl_L	Control voltage low level		0	0.4	V
Vctrl_H	Control voltage high level	2.4		7	V
I_V+	Positive supply DC current		5		mA
I_V-	Negative supply DC current		5		mA

These values are representative measurements in test fixture with bonding wires of typically 0.2nH at RF accesses.

Absolute Maximum Ratings ⁽¹⁾

Tamb.= +25°C

Symbol	Parameter	Values	Unit
V+	Maximum positive voltage	8	V
V-	Minimum negative voltage	-8	mA
Ai	CTRL voltage (Vctrl_low, Vctrl_high)	-2 to 8	V
Pin	Maximum Input power	27	dBm
Tj	Junction temperature	175	°C
Ta	Operating temperature range	-40 to +85	°C
Tstg	Storage temperature range	-55 to +150	°C

⁽¹⁾ Operation of this device above anyone of these parameters may cause permanent damage.

Definitions

n: Attenuator state index with $0 \leq n \leq 15$

Phase_S21(n) : Measured phase of S21 in degree at attenuation state n

dB_S21(n) : Measured magnitude of S21 in dB at attenuation state n

Attenuation Error (Att_err)

$$\text{Att_err}(n) = \text{dB_S21}(n) - \text{dB_S21}(0) - 1 \times n \text{ (dB)}$$

The translation of Att_err(n) from dB to linear is given by: $\text{Att_err_lin}(n) = 10^{\frac{\text{Att_err}(n)}{20}}$

Phase variation (Phivar)

$$\text{Phivar}(n) = \text{Phase_S21}(n) - \text{Phase_S21}(0) \text{ (}^\circ\text{)}$$

RMS Attenuation Error (Rms_att_err)

$$\text{Rms_att_err} = 20 \log \left(1 + \sqrt{\frac{1}{16} \cdot \sum_{n=0}^{15} (1 - \text{Att_err_lin}(n))^2} \right) \text{ (dB)}$$

RMS Phase variation (Rms_Phivar)

$$\text{Rms_Phivar} = \sqrt{\frac{\sum_{n=0}^{15} (\text{Phivar}(n))^2}{16}} \text{ (}^\circ\text{)}$$

Typical Bias Conditions

Tamb.= +25°C

Symbol	Pad N°	Parameter	Values	Unit
A1	2	Control voltage of attenuator bit 1	0 / +3.3 or +5	V
A2	3	Control voltage of attenuator bit 2	0 / +3.3 or +5	V
A3	4	Control voltage of attenuator bit 3	0 / +3.3 or +5	V
A4	5	Control voltage of attenuator bit 4	0 / +3.3 or +5	V
V+	8	Positive biasing voltage	+5	V
V-	7	Negative biasing voltage	-5	V

Attenuator control table

Voltage to apply on pads A1 to A4

State	Att (dB)	A4 (V)	A3 (V)	A2 (V)	A1 (V)
0	0	0	0	0	0
1	1	0	0	0	3.3
2	2	0	0	3.3	0
3	3	0	0	3.3	3.3
4	4	0	3.3	0	0
5	5	0	3.3	0	3.3
6	6	0	3.3	3.3	0
7	7	0	3.3	3.3	3.3
8	8	3.3	0	0	0
9	9	3.3	0	0	3.3
10	10	3.3	0	3.3	0
11	11	3.3	0	3.3	3.3
12	12	3.3	3.3	0	0
13	13	3.3	3.3	0	3.3
14	14	3.3	3.3	3.3	0
15	15	3.3	3.3	3.3	3.3

Typical on-wafer Sij parameters

Tamb.= +25°C, V+ =5V / V-=-5V / State=0

Freq (GHz)	S11 (dB)	PhS11 (°)	S12 (dB)	PhS12 (°)	S21 (dB)	PhS21 (°)	S22 (dB)	PhS22 (°)
1	-17.93	-12.28	-1.94	-15.55	-1.95	-15.43	-17.49	-8.43
2	-17.77	-25.59	-2	-30.45	-2	-30.28	-17.56	-18.14
3	-17.59	-38.73	-2.05	-45.39	-2.05	-45.19	-17.75	-27.17
4	-17.43	-50.85	-2.1	-60.17	-2.1	-60.06	-18.02	-35.54
5	-17.28	-62.55	-2.16	-75.13	-2.16	-74.94	-18.28	-43
6	-17.17	-73.11	-2.22	-89.89	-2.23	-89.81	-18.54	-49.59
7	-17.11	-83.64	-2.29	-104.81	-2.29	-104.65	-18.78	-55.74
8	-17.05	-93.17	-2.36	-119.55	-2.36	-119.45	-18.93	-61.74
9	-17.13	-102.36	-2.43	-134.42	-2.43	-134.23	-19.06	-68.09
10	-17.4	-111.2	-2.5	-149.25	-2.51	-148.96	-19.33	-74.92
11	-17.86	-120.15	-2.58	-164.12	-2.57	-163.77	-19.67	-82.08
12	-18.46	-128.81	-2.65	-179.07	-2.65	-178.73	-20.53	-88.34
13	-18.94	-132.89	-2.74	166.19	-2.73	166.42	-20.66	-92.09
14	-20.89	-140.47	-2.82	151.08	-2.81	151.24	-23.19	-93.58
15	-24.11	-143.82	-2.9	135.86	-2.91	136	-26.53	-81.55
16	-29.51	-127.35	-3.01	120.33	-3.02	120.59	-27.24	-43.86
17	-29.52	-64.64	-3.15	105.15	-3.14	105.18	-23.34	-22.61
18	-23.23	-47.71	-3.31	89.56	-3.32	89.78	-19.46	-20.22
19	-19.53	-50.82	-3.47	74.33	-3.51	74.42	-16.7	-26.03
20	-17.12	-57.9	-3.67	58.58	-3.68	59.4	-14.92	-34.21
21	-15.01	-66.57	-3.9	43.71	-3.87	43.77	-13.46	-44.23
22	-13.82	-77.18	-4.11	28.36	-4.1	28.56	-12.44	-54.33
23	-13.06	-86.4	-4.32	13.04	-4.33	13.3	-11.83	-64.16
24	-12.75	-95.03	-4.54	-2.24	-4.53	-1.83	-11.56	-72.84
25	-12.81	-101.68	-4.77	-17.35	-4.78	-17.04	-11.61	-80.74
26	-12.94	-109.49	-4.97	-32.46	-4.97	-32.18	-11.75	-86.94
27	-13.74	-115.02	-5.13	-47.55	-5.14	-47.29	-12.29	-90.94
28	-14.82	-116.72	-5.29	-63.03	-5.3	-62.73	-12.69	-91.53
29	-16.1	-110.75	-5.44	-78.66	-5.45	-78.61	-12.88	-90.52
30	-16.77	-97.38	-5.65	-94.85	-5.66	-94.58	-12.63	-90.06
31	-15.16	-83.58	-5.86	-111.14	-5.88	-110.79	-12.16	-90.83
32	-12.78	-77.91	-6.14	-127.63	-6.15	-126.95	-11.59	-92.37
33	-11	-82.34	-6.48	-143.89	-6.47	-143.4	-11.19	-95.25
34	-9.5	-86.41	-6.79	-160.21	-6.78	-159.72	-10.9	-97.57
35	-8.27	-93.8	-7.14	-176.1	-7.14	-175.71	-10.62	-101.52
36	-7.62	-100.81	-7.41	167.62	-7.41	168.04	-10.63	-103.87
37	-7.21	-105.84	-7.7	151.25	-7.72	151.58	-10.85	-104.31
38	-7.1	-111.46	-7.91	134.39	-7.88	134.98	-11.07	-103.23
39	-6.51	-115.07	-8.25	117.23	-8.25	117.59	-10.77	-100.78
40	-6.57	-118.62	-8.54	99.4	-8.52	99.79	-10.19	-98.29

Typical Board Measurements

Tamb.= +25°C, V+ = +5V, V- = -5V

Insertion Loss (Attenuator state 0)

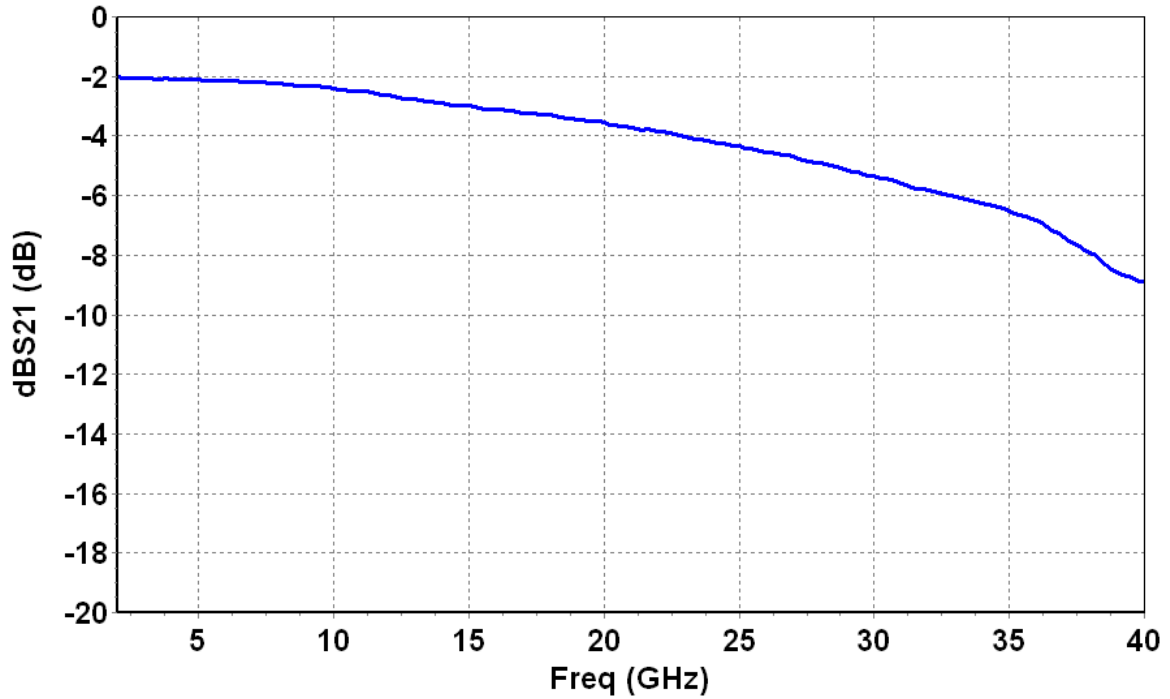

Input Return Loss All States

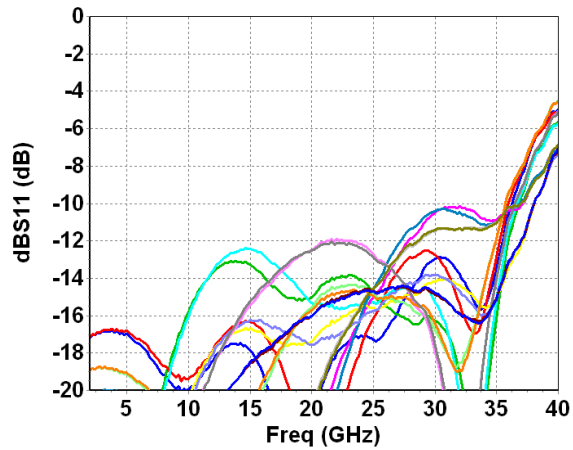

Output Return Loss All States

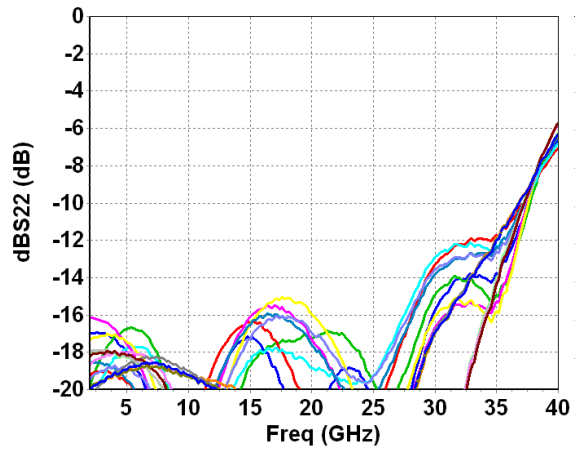

Typical Board Measurements

Tamb.= +25°C, V+ = +5V, V- = -5V

Attenuation Error versus Frequency
All states

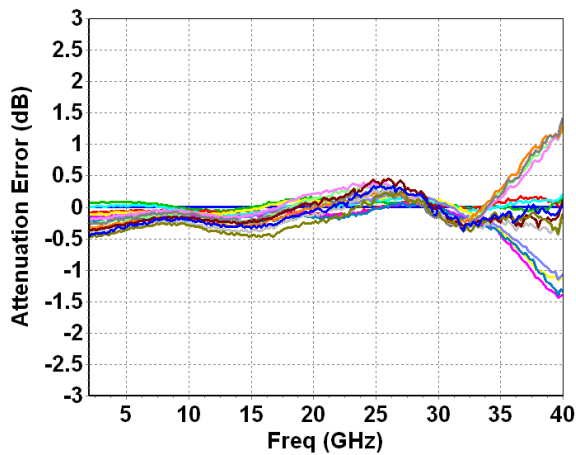

Attenuation Error versus States
2GHz < Frequency < 35GHz

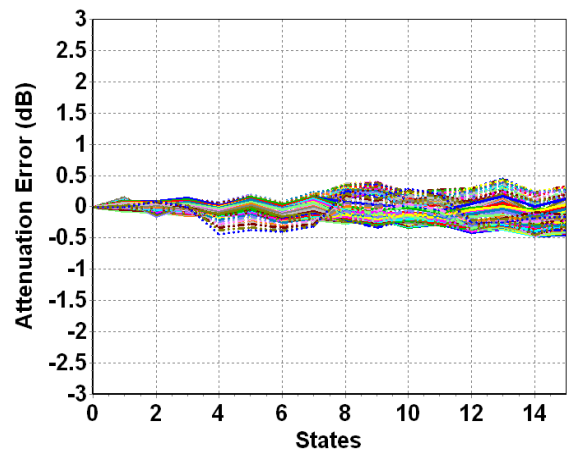

RMS Attenuation Error versus Frequency

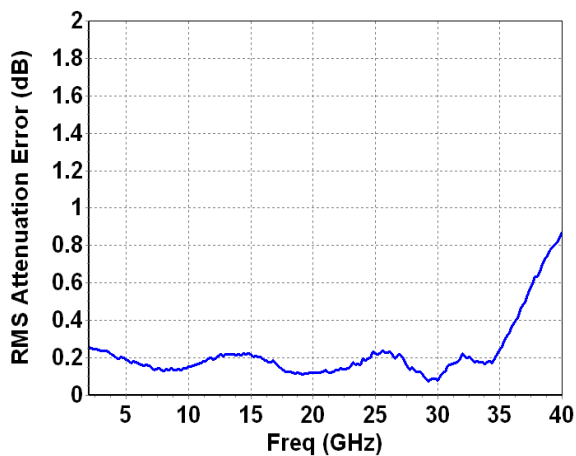

Attenuation versus States
2GHz < Frequency < 35GHz

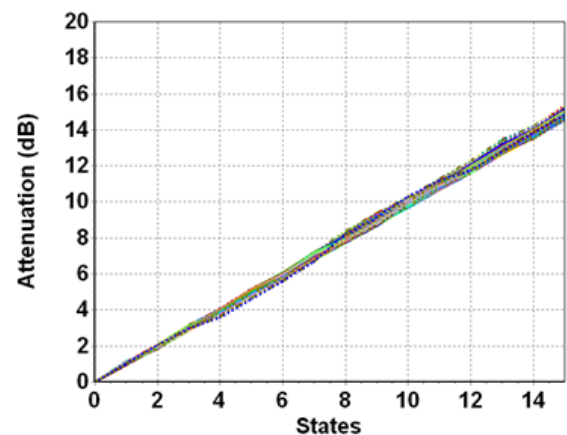

Typical Board Measurements

Tamb.= +25°C, V+ = +5V, V- = -5V

Phase Variation versus Frequency
All states

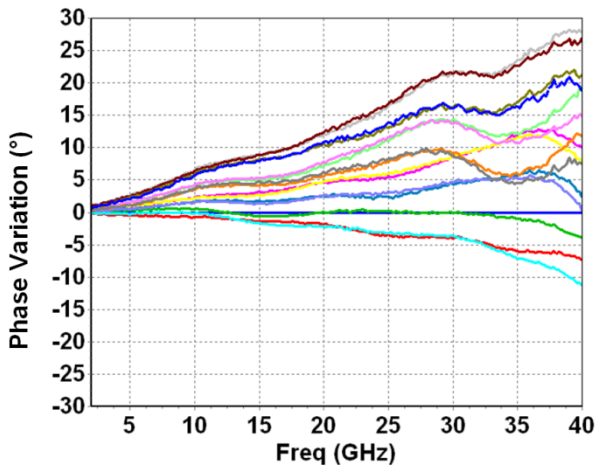

Phase Variation versus States
2GHz < Frequency < 35GHz

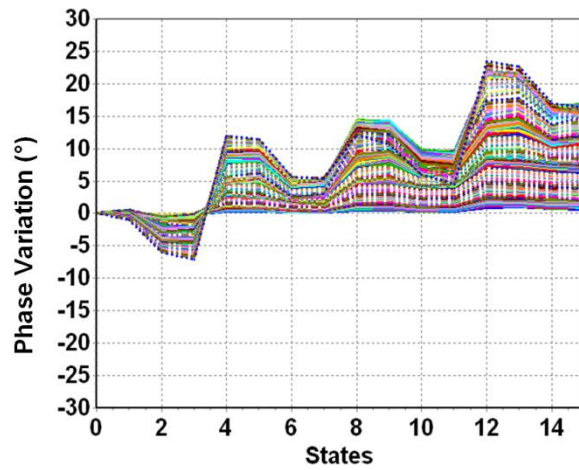

RMS of Phase Variation versus Frequency

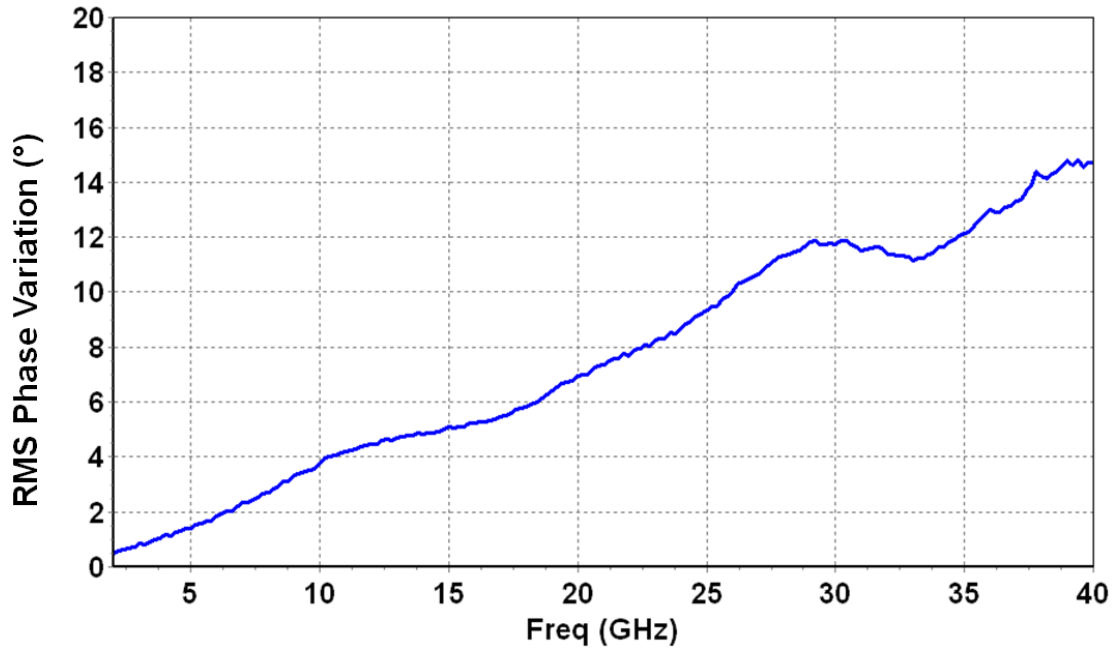

Mechanical dimensions and pad allocation

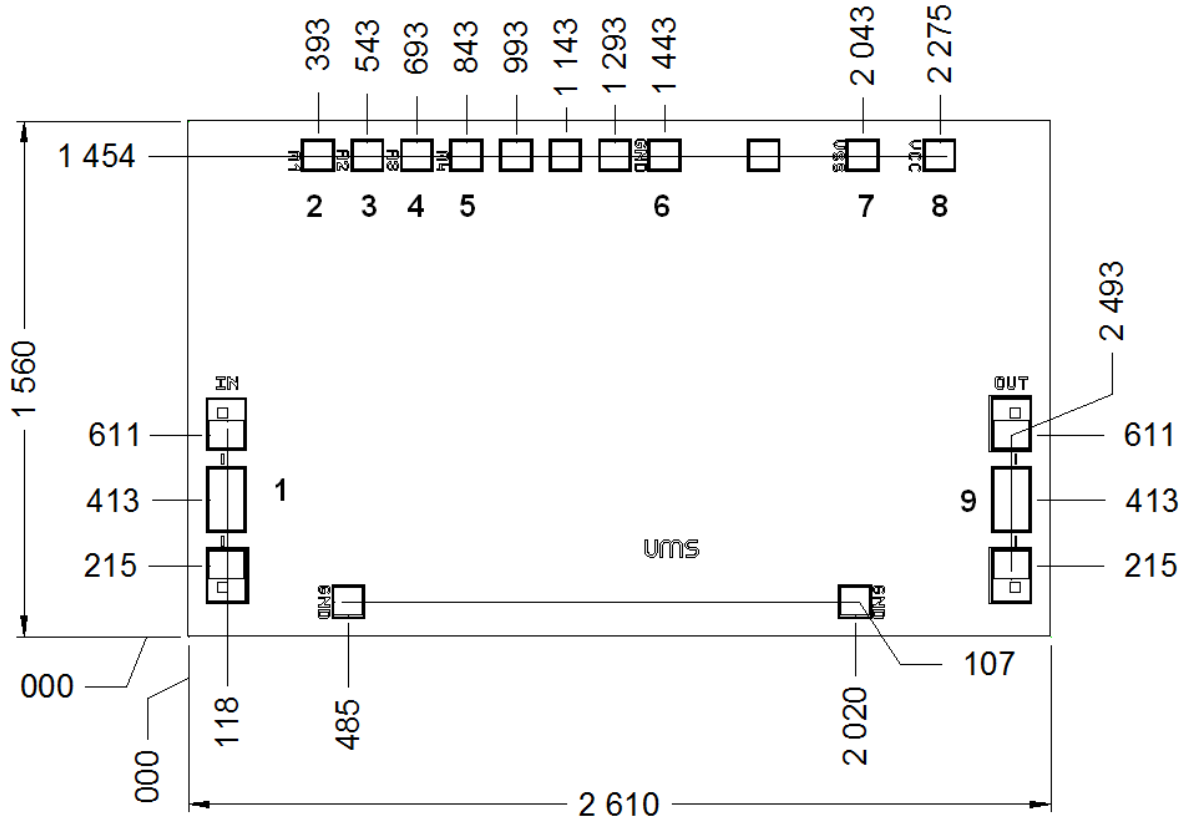

All dimensions are in micrometers

Chip size = 2610 x 1560 ±35µm
 Chip thickness = 100µm +/- 10µm.
 RF pads (1, 9) = 200 x 100µm²
 DC and control pads (2, 3, 4, 5, 6, 7, 8,) = 100 x 100µm²

Pin number	Pad name	Description
1	IN	Input RF
2	A1	Attenuator bit 1
3	A2	Attenuator bit 2
4	A3	Attenuator bit 3
5	A4	Attenuator bit 4
7	VSS	-5V supply voltage: interface
8	VCC	+5V supply voltage: interface
9	OUT	Output RF
6	GND	NC

Recommended assembly diagram

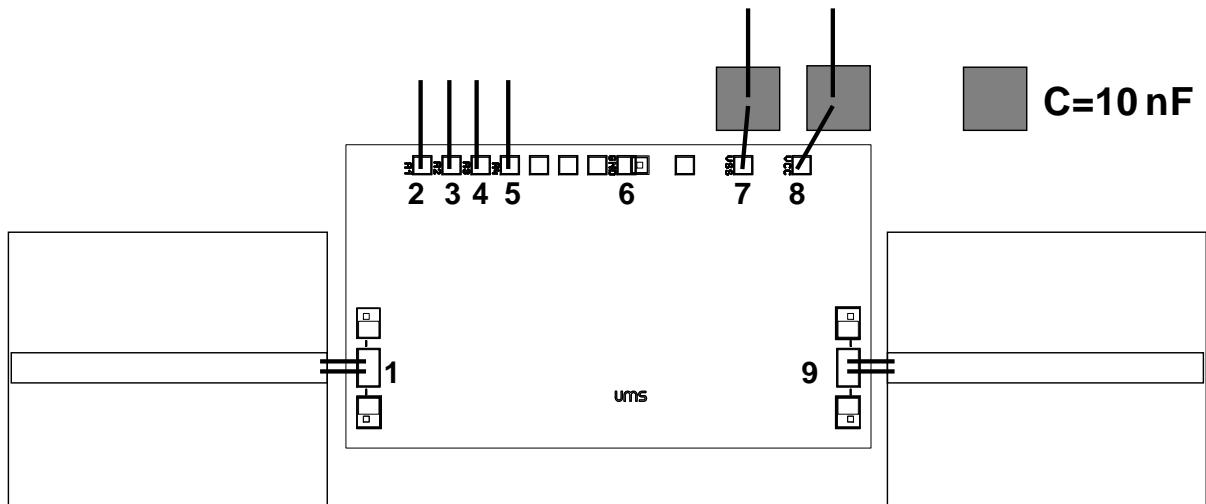

Recommended circuit bonding table

Label	Type	Decoupling	Comment
1, 9	RF	External DC block must be used to ensure DC decoupling	Input and Output accesses
2, 3, 4, 5	Vctrl	Not required	Bit control pads
7	V-	10nF	Negative Supply
8	V+	10nF	Positive Supply

Pads	Connections
1, 9	Inductance ($L_{bonding}$) < 0.2nH two wires: diameter 25 μ m, length < 300 μ m
2, 3, 4, 5, 7, 8	Inductance ($L_{bonding}$) = 0.8nH one wire: diameter 25 μ m, length 1mm

Notes



Recommended ESD management

Refer to the application note AN0020 available at <https://www.ums-rf.com> for ESD sensitivity and handling recommendations for the UMS products.

Recommended environmental management

UMS products are compliant with the regulation in particular with the directives RoHS N°2011/65 and REACH N°1907/2006. More environmental data are available in the application note AN0019 also available at <https://www.ums-rf.com>.

Ordering Information

Chip form:

CHT3029-99F/00

Information furnished is believed to be accurate and reliable. However **United Monolithic Semiconductors S.A.S.** assumes no responsibility for the consequences of use of such information nor for any infringement of patents or other rights of third parties which may result from its use. No license is granted by implication or otherwise under any patent or patent rights of **United Monolithic Semiconductors S.A.S.** Specifications mentioned in this publication are subject to change without notice. This publication supersedes and replaces all information previously supplied. **United Monolithic Semiconductors S.A.S.** products are not authorised for use as critical components in life support devices or systems without express written approval from **United Monolithic Semiconductors S.A.S.**