

DC-31GHz 4Bit Digital Attenuator

GaAs Monolithic Microwave IC in SMD leadless package

Description

The CHT3029-QEG is a very wide band digital attenuator, which integrates 4 bits with a LSB of 1dB and provides a dynamic range of 15dB from DC to 31GHz.

It is designed for a wide range of applications, from military to commercial communication systems.

The circuit is manufactured with a pHEMT process, 0.25 μ m gate length, via holes through the substrate, air bridges and electron beam gate lithography.

It is supplied in RoHS compliant SMD package.

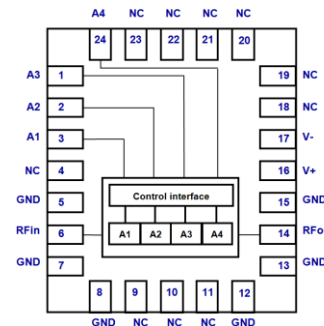
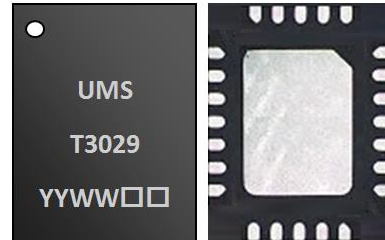

Main Features

- Broadband performances: DC-31GHz
- Insertion Loss: 4dB@20GHz 8dB@31GHz
- Attenuation step: 1dB
- Dynamic: 15dB
- RMS attenuation error: 0.5 dB
- Return Losses: 12dB
- DC bias: V+=5V and V-=-5V
- No internal DC Block at Input and Output RF accesses
- QFN 4x5

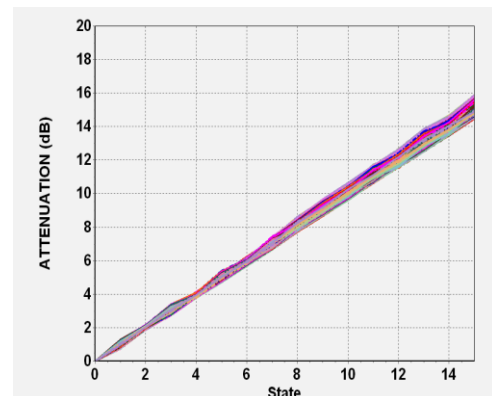

Main Electrical Characteristics

Tamb.= +25°C

Symbol	Parameter	Min	Typ	Max	Unit
Freq	Frequency range	DC		31	GHz
IL	Insertion Loss		4.0		dB
			8.0		dB
Rms_att_er	RMS of attenuation error		0.5		dB
Dyn	Dynamic		15		dB

Electrical Characteristics

Tamb.= +25°C, V+ = +5.0V V-=-5.0V

Symbol	Parameter	Min	Typ	Max	Unit
Freq	Frequency range	DC		31	GHz
IL	Insertion Loss		@20GHz	4.0	dB
			@31GHz	8.0	dB
S11	Input Return Loss		15		dB
S22	Output Return Loss		12		dB
P1dB	Input power at 1dB gain compression		20		dBm
Dyn	Dynamic		15		dB
LSB	Attenuator elementary step		1		dB
Att_err	Attenuation error		-0.5 +1		dB
Succ_Att	Attenuation error between 2 successive states		+/-0.4		dB
Rms_att_err	RMS attenuation error		0.5		dB
Phivar	Phase variation		-5/+20		°
Rms_phivar	RMS phase variation		8		°
Sw_t	Switching time		10		ns
V+	Positive supply voltage		5		V
V-	Negative supply voltage		-5		V
Vctrl_L	Control voltage low level		0	0.4	V
Vctrl_H	Control voltage high level	2.4	3.3/5	7	V
I_V+	Positive supply DC current		5		mA
I_V-	Negative supply DC current		5		mA
Ictrl	Control DC current		0.1		mA

The measurement calibration planes are defined in the paragraph “Definition of the Sij reference planes”.

Absolute Maximum Ratings ⁽¹⁾

Tamb.= +25°C

Symbol	Parameter	Values	Unit
V+	Maximum positive voltage	8	V
V-	Minimum negative voltage	-8	V
A1/A2/A3/A4	CTRL voltage (Vctrl_low, Vctrl_high)	-2 to 8	V
Pin	Maximum Input power	27	dBm
Ta	Operating temperature range	-40 to +85	°C
Tstg	Storage temperature range	-55 to +150	°C

⁽¹⁾ Operation of this device above anyone of these parameters may cause permanent damage.

Definitions

n: Attenuator state index with $0 \leq n \leq 15$

dB_S21(n) : Measured magnitude of S21 in dB at attenuation state n

Phase_S21(n) : Measured phase of S21 in degree at attenuation state n

Attenuation Error (Att_err)

$$\text{Att_err}(n) = \text{dB_S21}(n) - \text{dB_S21}(0) - 1 \times n \text{ (dB)}$$

The translation of Att_err(n) from dB to linear is given by: $\text{Att_err_lin}(n) = 10^{\frac{\text{Att_err}(n)}{20}}$

Successive State Attenuation Error (Succ_Att_err)

$$\text{Succ_Att_err}(n) = \text{dB_S21}(n) - \text{dB_S21}(n-1) - (-1)$$

Phase variation (Phivar)

$$\text{Phivar}(n) = \text{Phase_S21}(n) - \text{Phase_S21}(0) \text{ (}^\circ\text{)}$$

RMS Attenuation Error (Rms_att_err)

$$\text{Rms_att_err} = 20 \log \left(1 + \sqrt{\frac{1}{16} \cdot \sum_{n=0}^{15} (1 - \text{Att_err_lin}(n))^2} \right) \text{ (dB)}$$

RMS Phase variation (Rms_Phivar)

$$\text{Rms_Phivar} = \sqrt{\frac{\sum_{n=0}^{15} (\text{Phi var}(n))^2}{16}} \text{ (}^\circ\text{)}$$

Typical Bias Conditions

Tamb.= +25°C

Symbol	Pad N°	Parameter	Values	Unit
A1	3	Control voltage of attenuator bit 1	0 / +3.3 or +5	V
A2	2	Control voltage of attenuator bit 2	0 / +3.3 or +5	V
A3	1	Control voltage of attenuator bit 3	0 / +3.3 or +5	V
A4	24	Control voltage of attenuator bit 4	0 / +3.3 or +5	V
V+	16	Positive biasing voltage	+5	V
V-	17	Negative biasing voltage	-5	V

Attenuator control table

Voltage to apply on pads A1 to A4

State	Att (dB)	A4 (V)	A3 (V)	A2 (V)	A1 (V)
0	0	0	0	0	0
1	1	0	0	0	3.3
2	2	0	0	3.3	0
3	3	0	0	3.3	3.3
4	4	0	3.3	0	0
5	5	0	3.3	0	3.3
6	6	0	3.3	3.3	0
7	7	0	3.3	3.3	3.3
8	8	3.3	0	0	0
9	9	3.3	0	0	3.3
10	10	3.3	0	3.3	0
11	11	3.3	0	3.3	3.3
12	12	3.3	3.3	0	0
13	13	3.3	3.3	0	3.3
14	14	3.3	3.3	3.3	0
15	15	3.3	3.3	3.3	3.3

Typical Package Sij parameters

Tamb.= +25°C, V+/-5V / V=-5V State 0

Freq (GHz)	S11 (dB)	PhS11 (°)	S12 (dB)	PhS12 (°)	S21 (dB)	PhS21 (°)	S22 (dB)	PhS22 (°)
2.0	-16.5	-62.8	-2.2	-52.9	-2.1	-52.7	-17.8	-55.8
3.0	-15.8	-85.7	-2.3	-78.8	-2.2	-78.7	-18.5	-78.0
4.0	-15.6	-104.2	-2.3	-104.3	-2.3	-103.8	-18.8	-93.0
5.0	-15.6	-119.4	-2.5	-130.5	-2.4	-130.3	-19.0	-105.8
6.0	-15.7	-133.8	-2.5	-155.7	-2.5	-155.8	-18.4	-119.7
7.0	-16.2	-148.2	-2.6	178.8	-2.7	178.6	-17.9	-135.4
8.0	-16.8	-164.7	-2.7	153.1	-2.7	153.2	-17.9	-153.2
9.0	-17.5	175.1	-2.8	127.1	-2.7	126.5	-18.4	-172.6
10.0	-18.9	151.6	-2.9	101.1	-2.8	101.1	-20.0	170.5
11.0	-23.2	141.5	-3.0	74.7	-3.0	75.5	-21.8	128.9
12.0	-26.5	113.1	-3.1	49.1	-3.0	49.1	-25.1	114.5
13.0	-28.4	75.8	-3.2	22.8	-3.2	23.0	-29.9	116.6
14.0	-32.2	49.5	-3.3	-3.6	-3.3	-3.1	-31.7	155.0
15.0	-50.3	-33.2	-3.4	-29.8	-3.5	-29.4	-27.3	171.5
16.0	-30.1	-177.6	-3.6	-56.2	-3.6	-56.2	-23.1	172.3
17.0	-22.6	165.6	-3.8	-82.8	-3.8	-83.4	-19.3	162.5
18.0	-18.3	146.4	-4.1	-109.4	-4.0	-109.3	-16.7	145.7
19.0	-15.3	127.4	-4.4	-135.5	-4.3	-135.2	-14.5	130.5
20.0	-14.1	112.4	-4.6	-161.7	-4.6	-161.7	-14.0	107.7
21.0	-13.9	100.6	-4.8	172.2	-4.7	171.8	-14.0	88.3
22.0	-14.3	92.4	-4.9	145.2	-4.8	145.3	-15.2	71.1
23.0	-15.3	89.1	-5.1	118.1	-5.0	117.8	-17.3	59.5
24.0	-16.9	91.8	-5.3	90.6	-5.2	90.9	-18.9	54.9
25.0	-18.4	101.0	-5.4	63.0	-5.5	63.5	-18.7	52.6
26.0	-19.4	119.0	-5.7	35.1	-5.6	35.0	-17.0	27.2
27.0	-18.8	137.2	-6.0	7.2	-6.0	7.3	-15.9	-13.8
28.0	-17.2	149.7	-6.2	-21.2	-6.2	-20.6	-13.6	-47.1
29.0	-16.0	153.3	-6.5	-50.9	-6.5	-51.1	-11.5	-79.6
30.0	-16.7	150.7	-7.0	-81.9	-7.0	-81.9	-9.8	-105.0
31.0	-19.9	-177.5	-8.0	-111.7	-8.1	-111.4	-8.8	-125.6

Typical Board Measurements

Tamb.= +25°C, V+ = +5V, V- = -5V

Insertion Loss (Attenuator state 0)

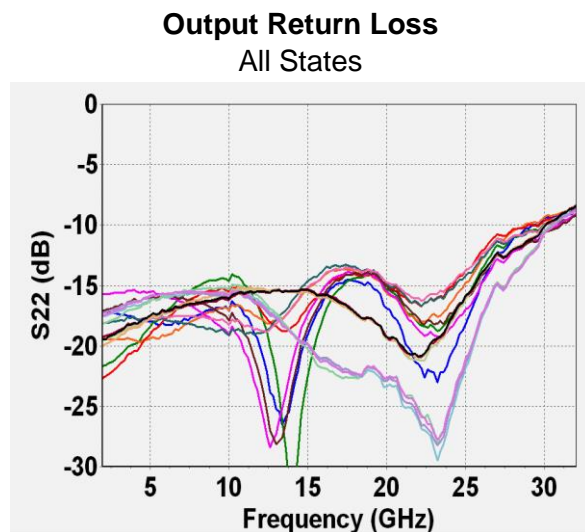
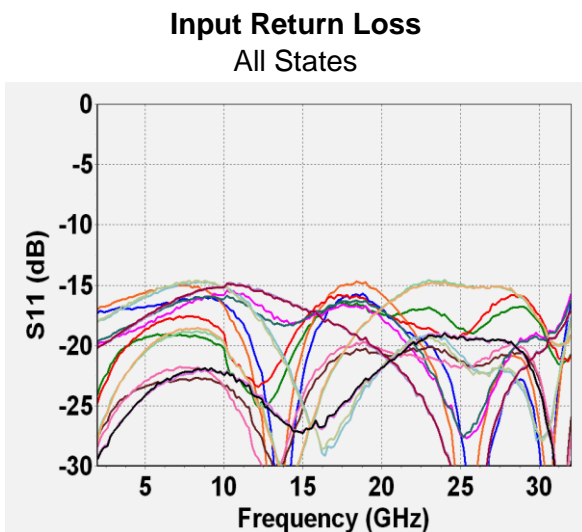
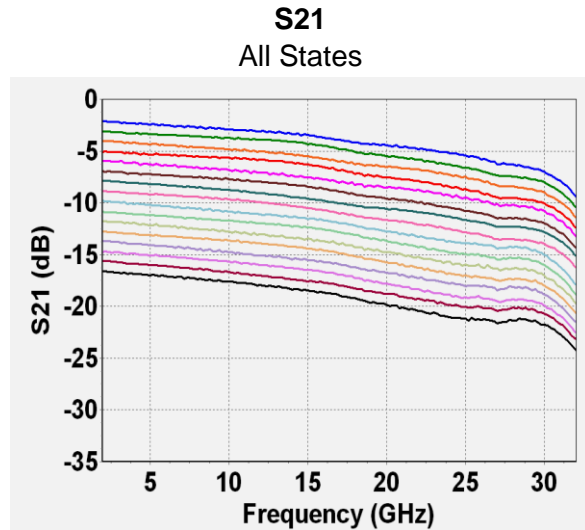
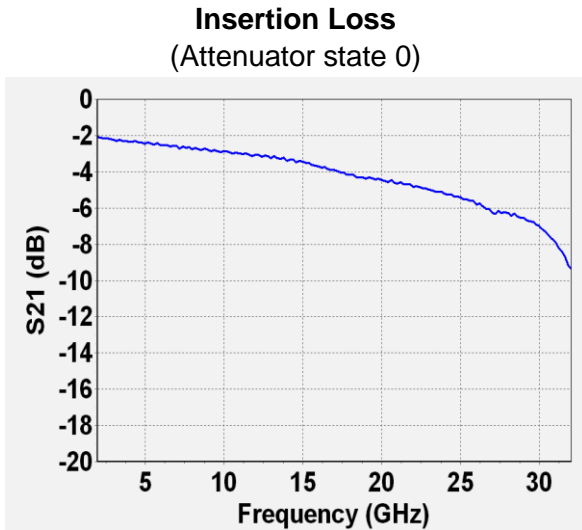

Typical Board Measurements

Tamb.= +25°C, V+ = +5V, V- = -5V

Attenuation Error versus Frequency
All states

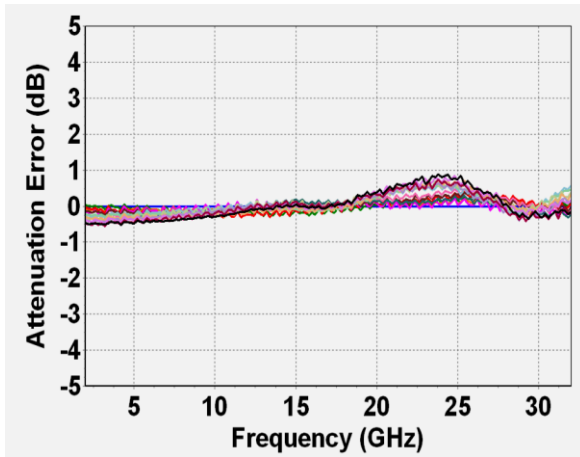

Attenuation Error versus State
2GHz < Frequency < 31GHz

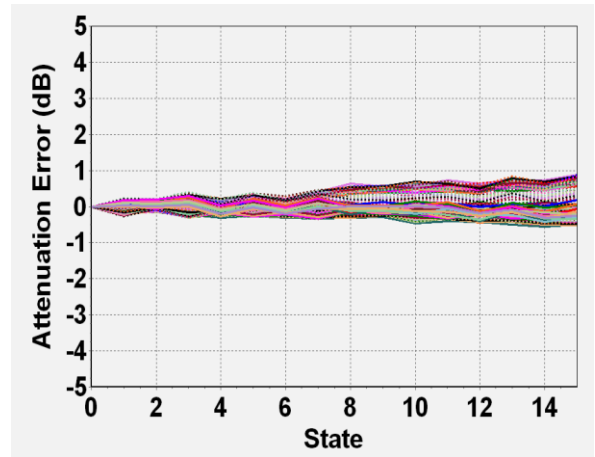

RMS Attenuation Error versus Frequency

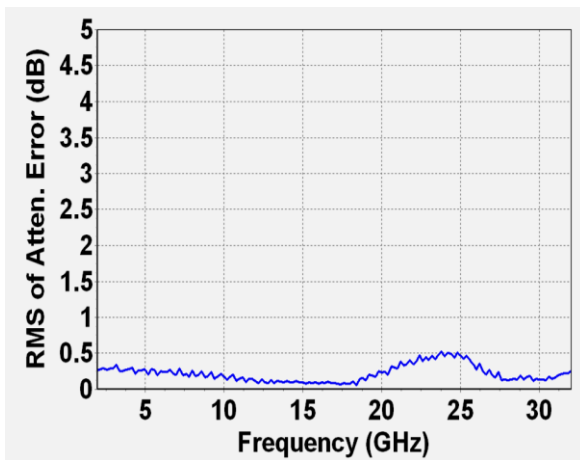

Successive Attenuation Error versus State
2GHz < Frequency < 31GHz

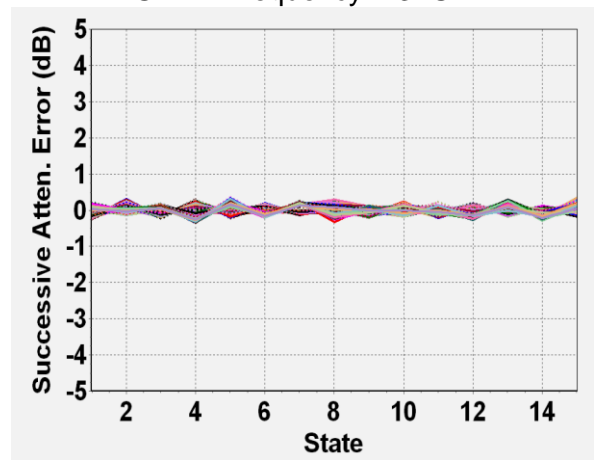

Typical Board Measurements

Tamb.= +25°C, V+ = +5V, V- = -5V

Phase Variation versus Frequency
All states

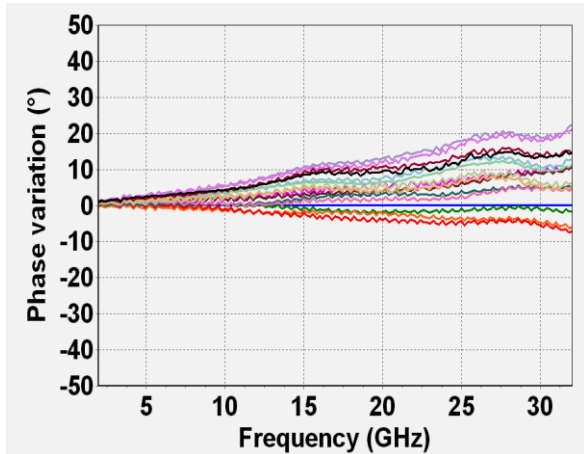

Phase Variation versus States
2GHz < Frequency < 31GHz

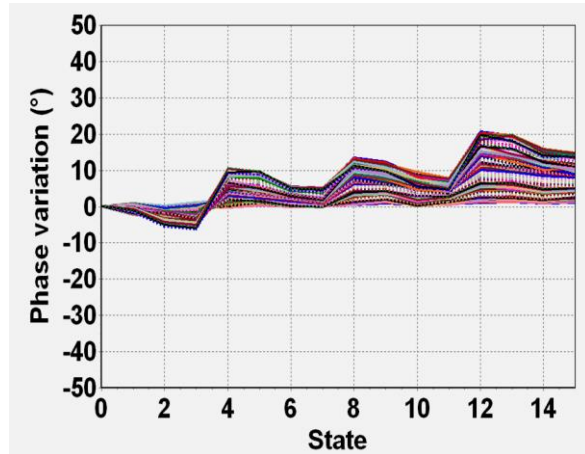

RMS of Phase Variation versus Frequency

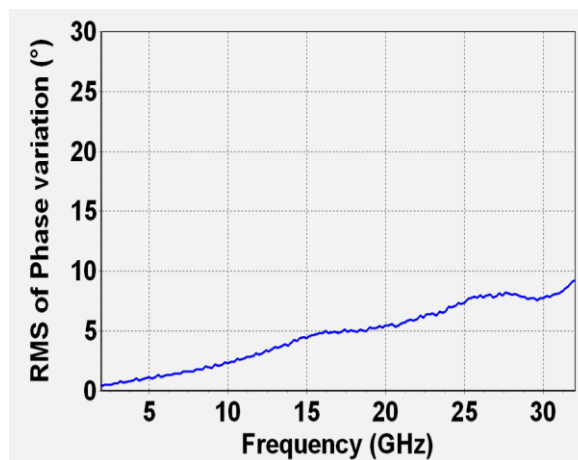

Package outline (1)

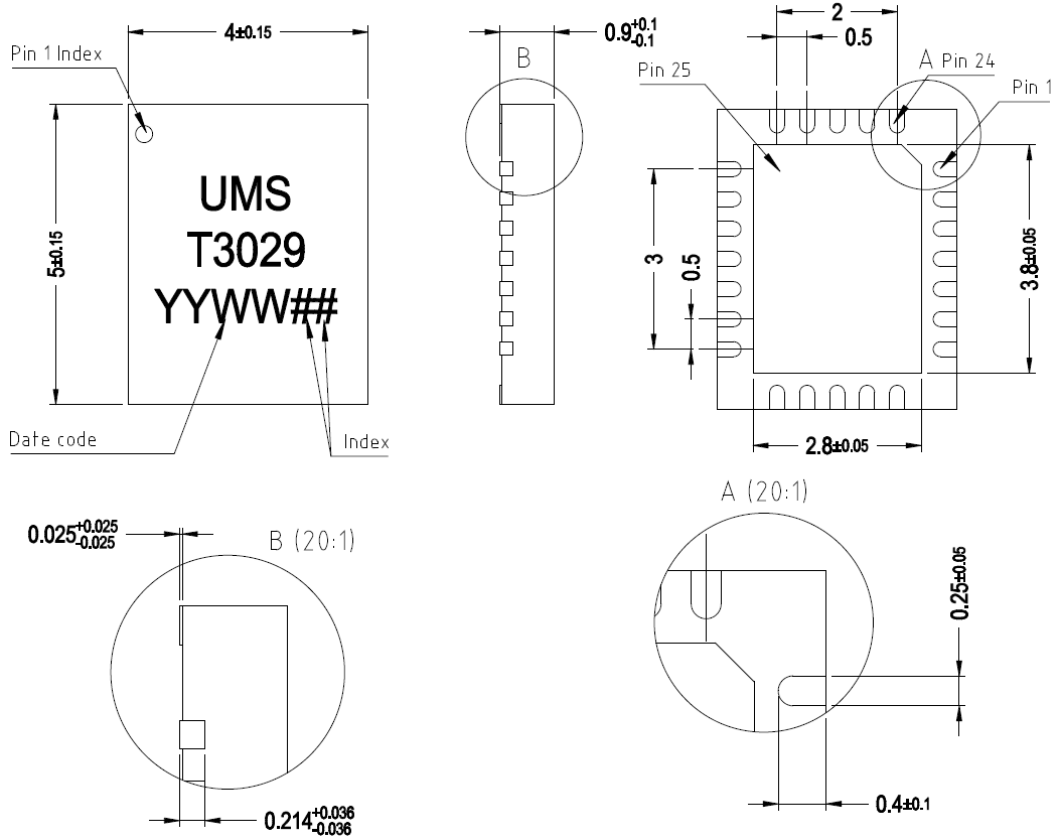

Matte tin, Lead Free	(Green)	1- A3	9- Nc	17- V-
Units :	mm	2- A2	10- Nc	18- Nc
From the standard :	JEDEC MO-220	3- A1	11- Nc	19- Nc
	(VGGD)	4- Nc	12- Gnd ⁽²⁾	20- Nc
	25- GND	5- Gnd ⁽²⁾	13- Gnd ⁽²⁾	21- Nc
		6- RF IN	14- RF OUT	22- Nc
		7- Gnd ⁽²⁾	15- Gnd ⁽²⁾	23- Nc
		8- Gnd ⁽²⁾	16- V+	24- A4

(1) The package outline drawing included to this data-sheet is given for indication. Refer to the application note AN0017 (<https://www.ums-rf.com>) for exact package dimensions.

(2) It is strongly recommended to ground all pins marked “Gnd” through the PCB board. Ensure that the PCB board is designed to provide the best possible ground to the package.

Definition of the Sij reference planes

The reference planes used for Sij measurements given above are symmetrical from the symmetrical axis of the package (see drawing below). The input and output reference planes are located at 3mm offset (input wise and output wise respectively) from this axis.

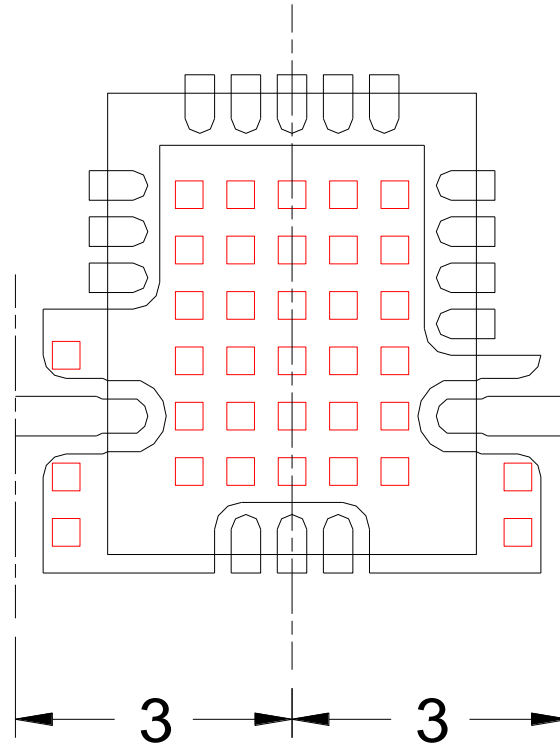

Package Information

Parameter	Value
Package body material	RoHS-compliant
	Low stress Injection Molded Plastic
Lead finish	100% matte tin (Sn)

Evaluation mother board

- Compatible with the proposed footprint.
- Based on typically Ro4003 / 8mils or equivalent.
- Using a micro-strip to coplanar transition to access the package.
- See application note AN0017 for details.

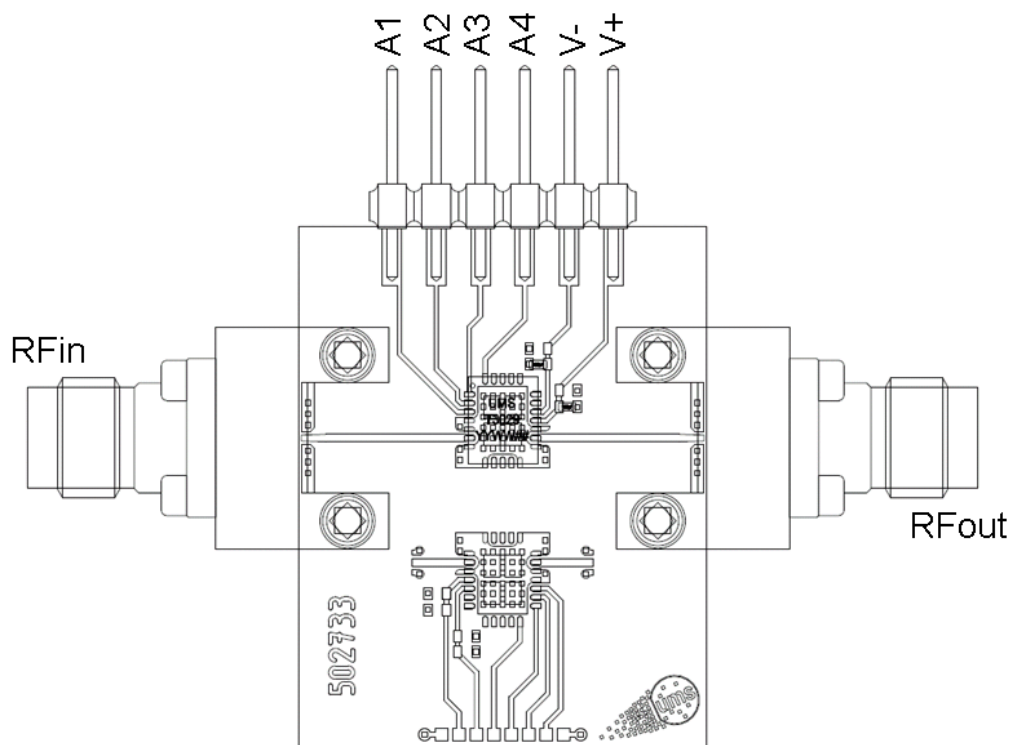

Recommended assembly table

Label	Pad number	Decoupling	Comment
RF IN RF OUT	6 14	External DC block must be used to ensure DC decoupling	Input and Output RF accesses
A1 A2 A3 A4	3 2 1 24	Not required	Bit control pads
V+	16	10nF	Positive Supply
V-	17	10nF	Negative Supply

Recommended package footprint

Refer to the application note AN0017 available at <https://www.ums-rf.com> for package footprint recommendations.

SMD mounting procedure

For the mounting process standard techniques involving solder paste and a suitable reflow process can be used. For further details, see application note AN0017.

Recommended environmental management

UMS products are compliant with the regulation in particular with the directives RoHS N°2011/65 and REACH N°1907/2006. More environmental data are available in the application note AN0019 also available at <https://www.ums-rf.com>.

Recommended ESD management

Refer to the application note AN0020 available at <https://www.ums-rf.com> for ESD sensitivity and handling recommendations for the UMS package products.

Ordering Information

QFN 4x5 package:

CHT3029-QEG/XY

Stick: XY = 20

Tape & reel: XY = 21

Information furnished is believed to be accurate and reliable. However **United Monolithic Semiconductors S.A.S.** assumes no responsibility for the consequences of use of such information nor for any infringement of patents or other rights of third parties which may result from its use. No license is granted by implication or otherwise under any patent or patent rights of **United Monolithic Semiconductors S.A.S.** Specifications mentioned in this publication are subject to change without notice. This publication supersedes and replaces all information previously supplied. **United Monolithic Semiconductors S.A.S.** products are not authorised for use as critical components in life support devices or systems without express written approval from **United Monolithic Semiconductors S.A.S.**