



**CHENMKO ENTERPRISE CO.,LTD**

**CHT4401TPT**

**SURFACE MOUNT  
NPN Switching Transistor**

VOLTAGE 40 Volts CURRENT 0.6 Ampere

Lead free devices

**APPLICATION**

- \* Telephony and professional communication equipment.
- \* Other switching applications.

**FEATURE**

- \* Small surface mounting type. (SC-75/SOT-416)
- \* Low current (Max.=600mA).
- \* Suitable for high packing density.
- \* Low voltage (Max.=40V) .
- \* High saturation current capability.
- \* Voltage controlled small signal switch.

**CONSTRUCTION**

- \* NPN Switching Transistor

**MARKING**

- \* NT



SC-75/SOT-416

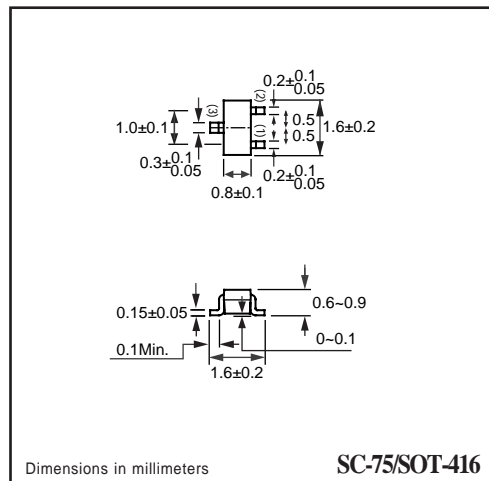

**CIRCUIT**

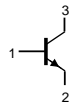

**LIMITING VALUES**

In accordance with the Absolute Maximum Rating System (IEC 60134).

SYMBOL	PARAMETER	CONDITIONS	MIN.	MAX.	UNIT
V <sub>CBO</sub>	collector-base voltage	open emitter	—	60	V
V <sub>CEO</sub>	collector-emitter voltage	open base	—	40	V
V <sub>EBO</sub>	emitter-base voltage	open collector	—	6	V
I <sub>C</sub>	collector current DC		—	600	mA
P <sub>tot</sub>	total power dissipation	T <sub>amb</sub> ≤ 25 °C; note 1	—	200	mW
T <sub>stg</sub>	storage temperature		-55	+150	°C
T <sub>j</sub>	junction temperature		—	150	°C
T <sub>amb</sub>	operating ambient temperature		-55	+150	°C

**Note**

2004-11

1. Transistor mounted on an FR4 printed-circuit board.

## RATING CHARACTERISTIC CURVES ( CHT4401TPT )

### THERMAL CHARACTERISTICS

SYMBOL	PARAMETER	CONDITIONS	VALUE	UNIT
$R_{th\ j-a}$	thermal resistance from junction to ambient	note 1	200	°C/W

#### Note

1. Transistor mounted on an FR4 printed-circuit board.

### CHARACTERISTICS

$T_{amb} = 25\text{ °C}$  unless otherwise specified.

SYMBOL	PARAMETER	CONDITIONS	MIN.	MAX.	UNIT
$I_{CBO}$	collector cut-off current	$I_E = 0; V_{CB} = 60\text{ V}$	–	50	nA
$I_{EBO}$	emitter cut-off current	$I_C = 0; V_{EB} = 6\text{ V}$	–	50	nA
$h_{FE}$	DC current gain	$V_{CE} = 1\text{ V}$ ; note 1 $I_C = 0.1\text{ mA}$ $I_C = 1\text{ mA}$ $I_C = 10\text{ mA}$ $I_C = 150\text{ mA}$ $V_{CE} = 2\text{ V}$ ; note 2 $I_C = 500\text{ mA}$	20 40 80 100 40	– – – 300 –	
$V_{CEsat}$	collector-emitter saturation voltage	$I_C = 150\text{ mA}; I_B = 15\text{ mA}$	–	400	mV
		$I_C = 500\text{ mA}; I_B = 50\text{ mA}$	–	750	mV
$V_{BEsat}$	base-emitter saturation voltage	$I_C = 150\text{ mA}; I_B = 15\text{ mA}$	750	950	mV
		$I_C = 500\text{ mA}; I_B = 50\text{ mA}$	–	1200	mV
$C_c$	collector capacitance	$I_E = I_E = 0; V_{CB} = 5\text{ V}; f = 140\text{ KHz}$	–	6.5	pF
$C_e$	emitter capacitance	$I_C = I_C = 0; V_{BE} = 500\text{ mV}; f = 140\text{ KHz}$	–	30	pF
$f_T$	transition frequency	$I_C = 20\text{ mA}; V_{CE} = 10\text{ V}; f = 100\text{ MHz}$	250	–	MHz

#### Switching times (between 10% and 90% levels);

$t_{on}$	turn-on time	$I_{Con} = 150\text{ mA}; I_{Bon} = 15\text{ mA}; I_{Boff} = -15\text{ mA}$	–	35	ns
$t_d$	delay time		–	15	ns
$t_r$	rise time		–	20	ns
$t_{off}$	turn-off time		–	250	ns
$t_s$	storage time		–	200	ns
$t_f$	fall time		–	60	ns

#### Note

1. Pulse test:  $t_p \leq 300\text{ }\mu\text{s}$ ;  $\delta \leq 0.02$ .

## RATING CHARACTERISTIC CURVES ( CHT4401TPT )

### Typical Characteristics

**Typical Pulsed Current Gain vs Collector Current**

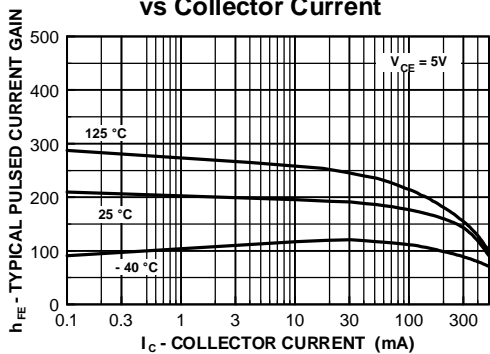

**Collector-Emitter Saturation Voltage vs Collector Current**

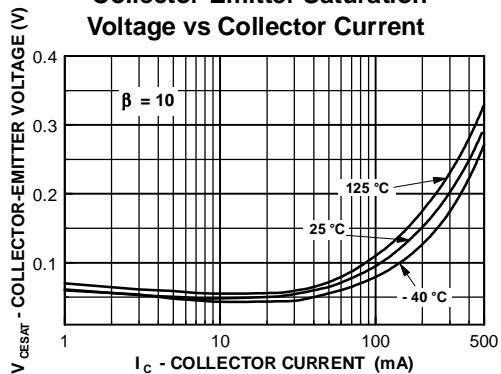

**Base-Emitter Saturation Voltage vs Collector Current**

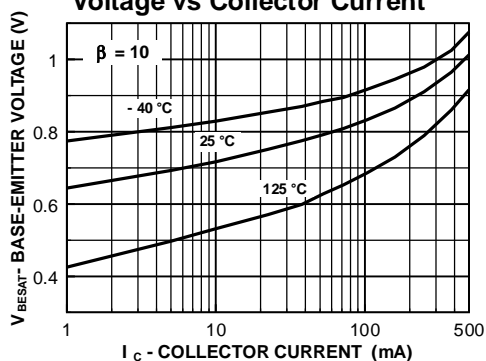

**Base-Emitter ON Voltage vs Collector Current**

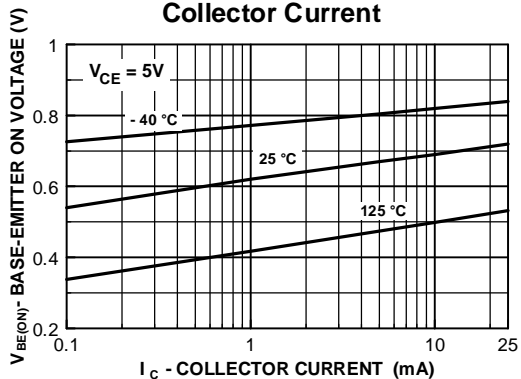

**Collector-Cutoff Current vs Ambient Temperature**

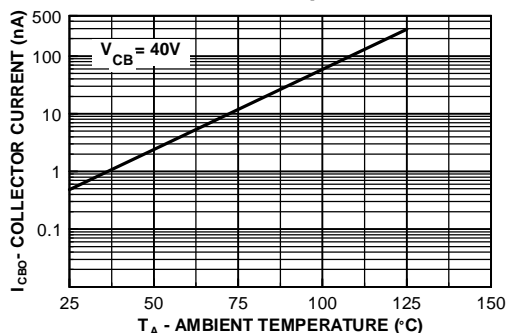

**Emitter Transition and Output Capacitance vs Reverse Bias Voltage**

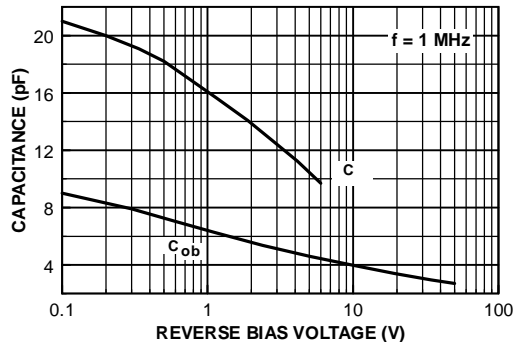

## RATING CHARACTERISTIC CURVES ( CHT4401TPT )

**Turn On and Turn Off Times  
vs Collector Current**

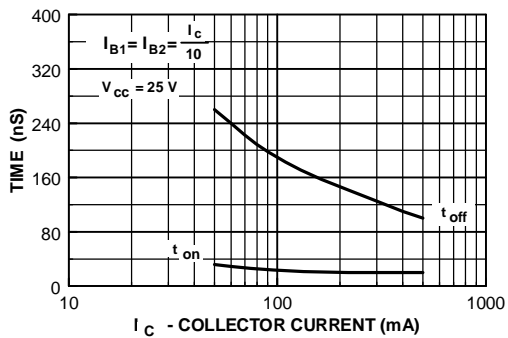

**Switching Times  
vs Collector Current**

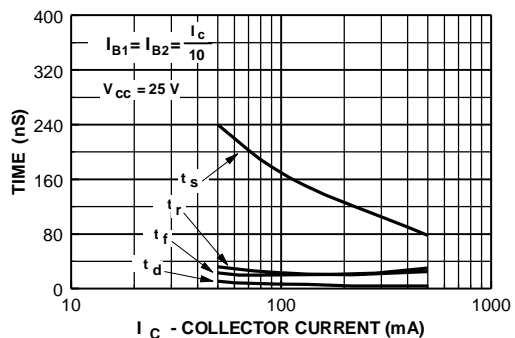

**Power Dissipation vs  
Ambient Temperature**

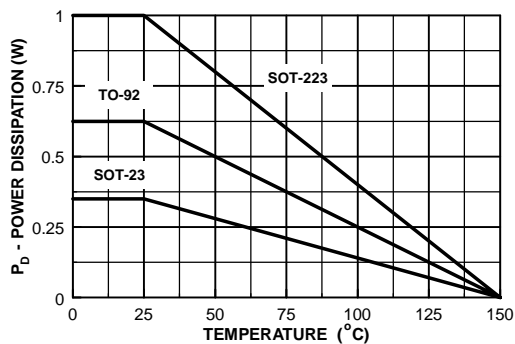

## RATING CHARACTERISTIC CURVES ( CHT4401TPT )

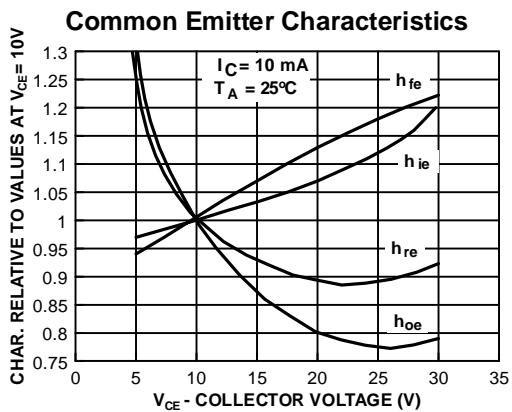
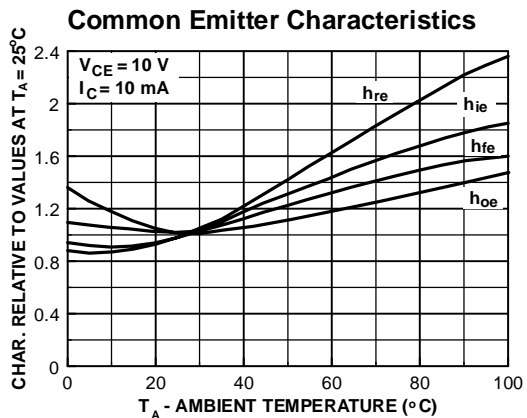
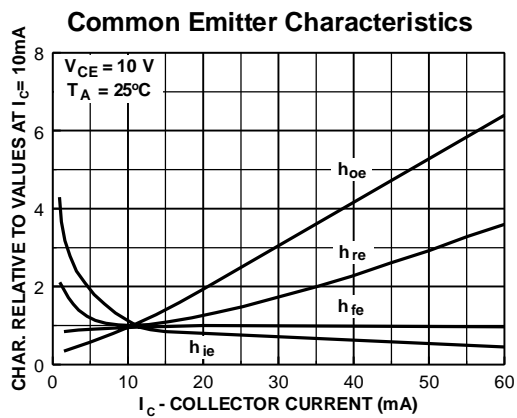

RATING CHARACTERISTIC CURVES ( CHT4401TPT )

Test Circuits

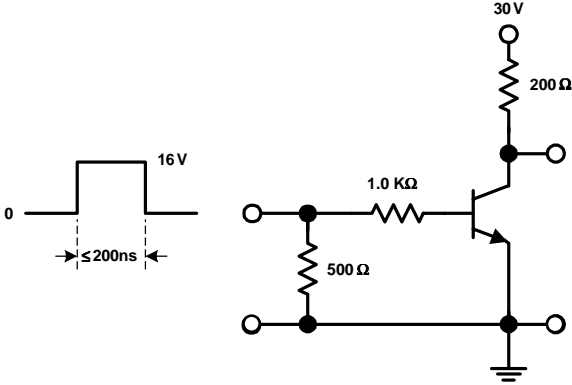

FIGURE 1: Saturated Turn-On Switching Timer

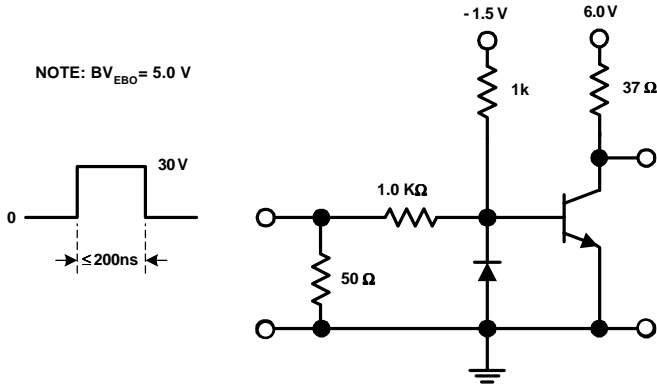

FIGURE 2: Saturated Turn-Off Switching Time