

## 24-24.5GHz Tx Multifunction

### GaAs Monolithic Microwave IC in SMD leadless package

#### Description

The CHV2421-QDG is a monolithic multifunction for dual channel frequency generation. It integrates a X-band “push-push” oscillator with frequency control thanks to base collector diodes, used as varactors, two K-Band buffers with a “Mute” power control command ( $M_1, M_2$ ) for each output, and a frequency divider by 8.

The circuit is dedicated to sensors and also well suited for a wide range of microwave and millimeter wave applications and systems.

The circuit is manufactured with a standard InGaP HBT process,  $2\mu\text{m}$  emitter length, via holes through the substrate, and high Q passive elements.

It is supplied in a 24 leads RoHS compliant QFN4x4 package.

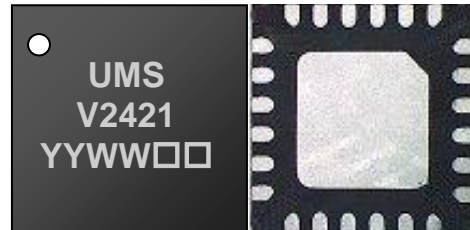

Plastic package

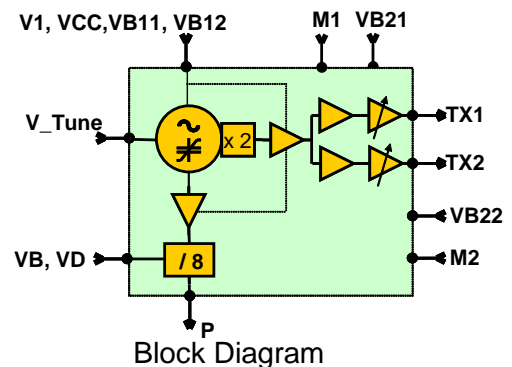

Block Diagram

#### Main Features

- 24-24.5GHz frequency tuning range
- -90dB/Hz phase Noise
- 15dBm typical output power
- +5V single supply Voltage
- 24L-QFN 4x4 SMD leadless package
- MSL1

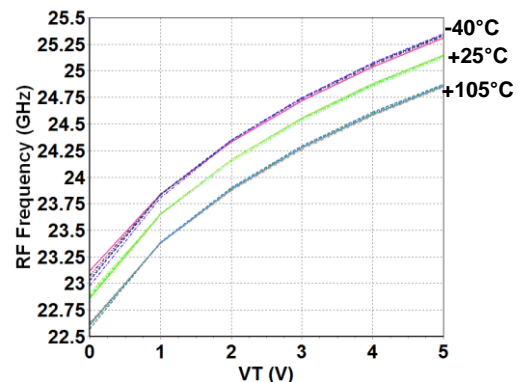

Frequency vs tuning voltage (-40/25/105°C)

#### Main Electrical Characteristics

Tamb.= +25°C

Symbol	Parameter	Min	Typ	Max	Unit
Freq	Frequency range	24		24.5	GHz
P_TXn	Typical output power on both channel		15		dBm
PN	Phase Noise @ 100kHz		-90	-80	dBc/Hz
PW_TX_16	Prescaler Output Power		0		dBm
V_Tune	Tuning Voltage	0.5		5.5	V

## Electrical Characteristics

Temp.= -40°C to +105°C

Symbol	Parameter	Min	Typ	Max	Unit	Conditions
F_TX	Output Frequency	24		24.5	GHz	
F_VCO	Core VCO frequency	F_Tx/2			GHz	
V_Tune	Voltage Tuning within F_TX	0.5		5.5	V	
T_sens	Tuning sensitivity within F_TX	225	450	850	MHz/V	
F_drift	Temperature frequency drift rate		3	5	MHz/°C	
H1	Harmonics 1/2 F_TX power (TX1 & TX2 ports)		-15	-5	dBm	
H3	Harmonics 3/2 F_TX power (TX1 & TX2 ports)		-45	-30	dBm	
H4	Harmonics 2 F_TX power (TX1 & TX2 ports)		-40	-25	dBm	
Sp_TX	Non-harmonic spurious rejection at TX1, TX2 ports	70	80		dBc	
Pres_TX	Prescaler spurious rejection at TX1, TX2 ports	45	55		dBc	
PN	SSB Phase Noise @ 100KHz at TXn		- 90	- 80	dBc/Hz	
VSWR_RF	RF Output (TX1, TX2) VSWR		1,5:1	2,5:1		VB21, VB22>3.15V
LP_RF	RF Load Pulling into 2.5:1 VSWR all phases (Tx1, Tx2)			8	MHz	
Push	Bias pushing (VCC, VB, VD, V1, VB11, VB12, VB21, VB22, M1, M2)		50	250	MHz/V	
P_TX1 (1)	Nominal output Power on TX1	10.5	15.5	18.5	dBm	4.9<Supplies<5.1V M1_v<0.2V or NC
P_TX1_T°C	P_TX1 Temperature coefficient	-2e-4 *T - 0.0219			dB/°C	dP/dT
P_TX2 (1)	Nominal output Power on TX2	9.5	15	19.5	dBm	4.9<Supplies<5.1V M1_v<0.2V or NC
P_TX2_T°C	P_TX2 Temperature coefficient	-4e-4 *T - 0.0179			dB/°C	dP/dT
D_P_TXn	Output Power Dynamic Range on TX1 & TX2 with VB2n controlled	8	13		dB	
L_P_TXn	Low Power level on TXn with VB2n<2.25V			8.75	dBm	
P_TX1_LO (2)	TX1 Power if VB21=3.3V & M1_v<0.2V/NC	1	6	10	dBm	
P_TX2_OFF	TX2 Power if VB22<2.25V & M2_v>3.15V		-14	-7	dBm	

**Electrical Characteristics (Cont.)**

F_TX_16	TX_16 Output Frequency	F_TX/16			GHz	
L_TX_16	TX_16 Output Load		50		$\Omega$	
PW_TX_16	TX_16 Output Power	-4	0	3.5	dBm	
Pres_SWP	Prescaler VD switching pulling		8	15	MHz	
VB21, VB22	VB2n Control voltage range for P_TXn power Highest level Lowest level	4.7 1.75		5.3 2.25	V	
Mn_v	Txn Mute control voltage Mute ON Mute OFF	4.7 0		5.3 0.2 or NC	V	
T_Mute	Mute recovery time		100	250	$\mu$ s	
VCC, VB, VD, V1, VB11, VB12	Supply voltage	4.7	5	5.3	V	
I_VCC	Supply Current on VCC		50	75	mA	
I_VB	Supply Current on VB		10	14	mA	
I_VD	Supply Current on VD		80	140	mA	
I_V1	Supply Current on V1		13	21	mA	
I_VB1n	Supply Current on VB11 or VB12		23	32	mA	
I_VB2n	Supply Current on VB21 or VB22		45	70	mA	
I_Mn	Max Supply Current on M1 or M2		2	3.5	mA	
Top	Operating temperature range	-40		+105	$^{\circ}$ C	Top=Tcase

(1) As measured on UMS recommended test fixture.

(2) Recommended configuration to reduce TX1 output power range to feed a single CHR2421.

Packaged TX is conditionally Stable (Stability guaranteed on UMS demo-board and for RF loads VSWR <3:1).

Full temperature and supply voltage range.

## Absolute Maximum Ratings

T<sub>amb.</sub> = +25°C

Symbol	Parameters	Values	Unit
VCC, VB, VD, V1, VB11, VB12, VB21, VB22, M1, M2	Maximum positive supply voltage <sup>(1)</sup> Minimum positive supply voltage <sup>(1)</sup>	6 -0.5	V
VT	Maximum positive supply voltage <sup>(1) (3)</sup> Minimum positive supply voltage <sup>(1)</sup>	10 -0.5	V
+I_VT	VT Maximum positive supply current <sup>(1)</sup>	2	mA
+I_VCC	VCC Maximum positive supply current <sup>(1)</sup>	85	mA
+I_VB	VB Maximum positive supply current <sup>(1)</sup>	20	mA
+I_VD	VD Maximum positive supply current <sup>(1)</sup>	140	mA
+I_V1	V1 Maximum positive supply current <sup>(1)</sup>	30	mA
+IVB1n	VB1n Maximum positive supply current <sup>(1)</sup>	40	mA
+IVB2n	VB2n Maximum positive supply current <sup>(1)</sup>	80	mA
+IMn	IMn Maximum positive supply current <sup>(1)</sup>	4	mA
T <sub>j</sub>	Junction temperature <sup>(2)</sup>	175	°C
T <sub>op</sub>	Operating temperature range <sup>(2)</sup>	-40 to +125	°C
T <sub>stg</sub>	Storage temperature range	-55 to +150	°C

<sup>(1)</sup> Operation of this device above anyone of these parameters may cause permanent damage.

<sup>(2)</sup> T<sub>op</sub>=T<sub>case</sub>. Operation of this device above these parameters may cause permanent damage or reduce MTTF.

<sup>(3)</sup> Voltage applied through 220Ω serial resistor to limit VT current below 2mA DC, and duration should not exceed 1s.

### Device thermal performances

All the figures given in this section are obtained assuming that the QFN device is cooled down only by conduction through the package thermal pad (no convection mode considered).

The temperature is monitored at the package back-side interface (Tcase) as shown below. The system maximum temperature must be adjusted in order to guarantee that Tcase remains below than the maximum value specified in the next table. So, the system PCB must be designed to comply with this requirement.

A derating must be applied on the dissipated power if the Tcase temperature can not be maintained below than the maximum temperature specified (see the curve Pdiss. Max) in order to guarantee the nominal device life time (MTTF).

DEVICE THERMAL SPECIFICATION :			
Recommended max. junction temperature (Tj max) <sup>(1)</sup>			: 150 °C
Junction temperature absolute maximum rating			: 175 °C
Max. continuous dissipated power @ Tcase=	105	°C	: 2,4 W
=> Pdiss derating above Tcase <sup>(2)</sup> =	105	°C	: 47 mW/°C
Junction-Case thermal resistance (Rth Jc) <sup>(3)</sup>			: <21 °C/W
Minimum Tcase operating temperature <sup>(4)</sup>			: -40 °C
Maximum Tcase operating temperature <sup>(4)(5)</sup>			: 105 °C
Absolute maximum rating Tcase temperature <sup>(4)(5)</sup>			: 125 °C
Minimum storage temperature			: -55 °C
Maximum storage temperature			: 150 °C

(1) Typical supply voltage considered @ Tcase=105°C.

(2) Derating at junction temperature constant = Tj max

(3) Rth J -C is calculated for a worst case where the **hottest junction** of the MMIC is considered, and all component biasing are supplied.

(4) Tcase=Package back side temperature measured under the die -attach-pad (see the drawing below).

(5) Typical supply voltage considered 5V

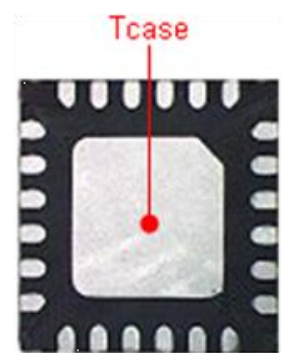
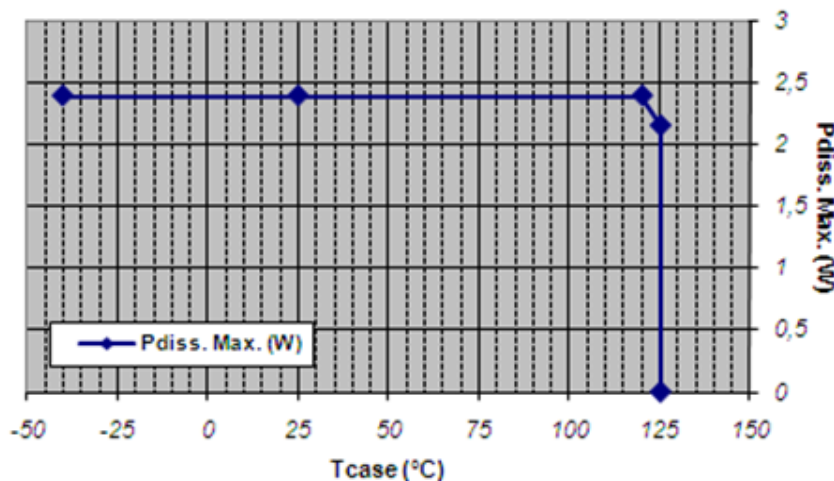

Example: QFN 24L 4x4  
Location of temperature reference point (Tcase) on package's bottom side

## Typical Board Measurements (QFN plan)

All supplies= +4.7V; +5V; +5.3V

Typical Frequency over Tuning Voltage and Temperature

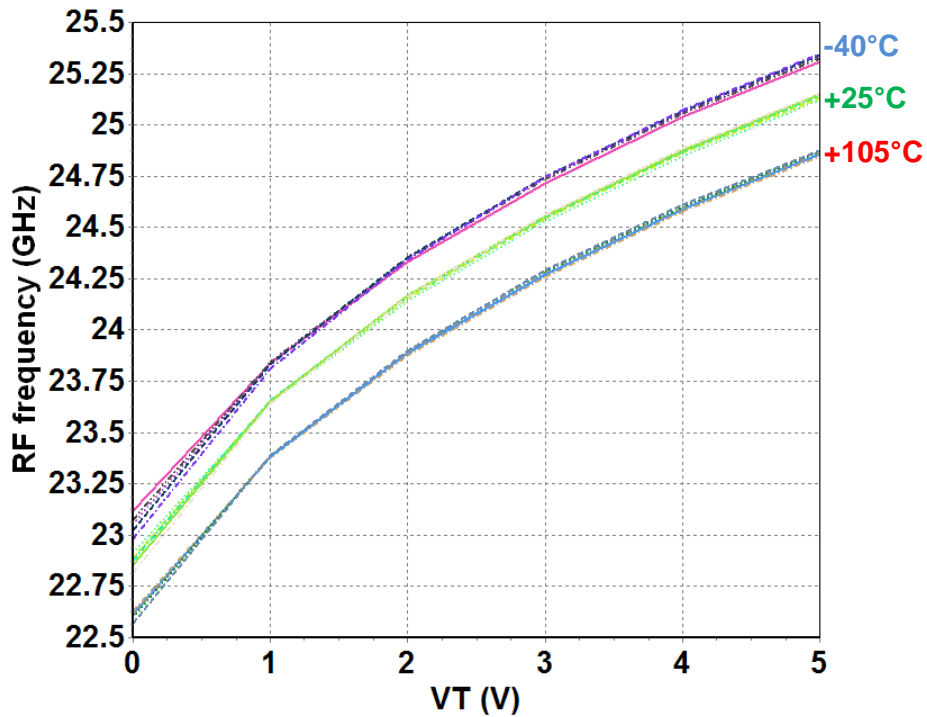

Typical SSB Phase Noise @100kHz

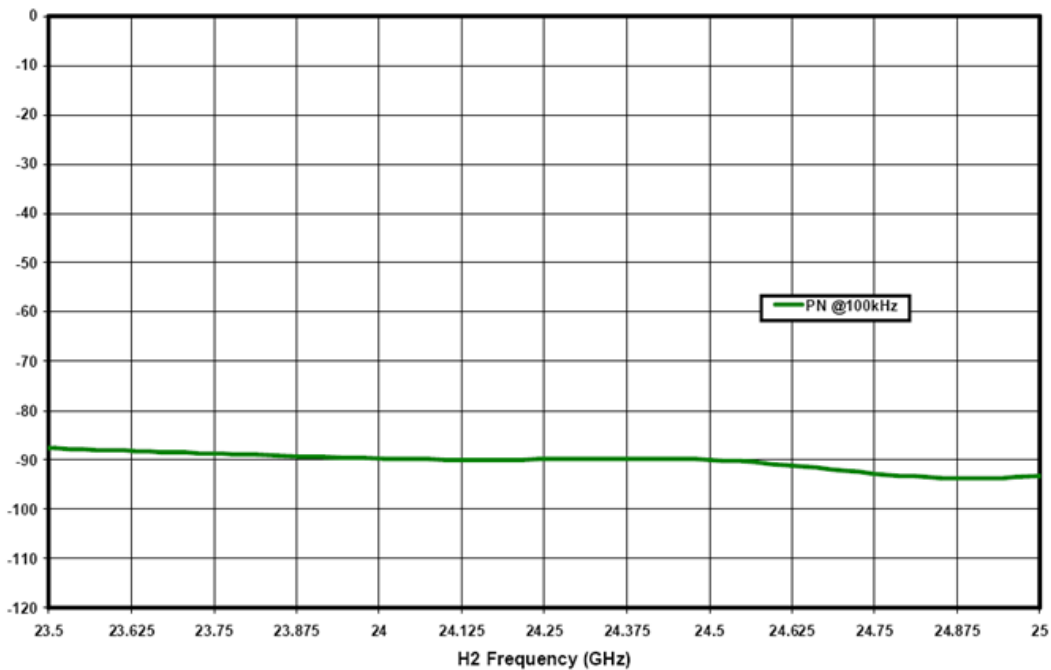

Typical Board Measurements (QFN plan)

All supplies= +5V

Typical Output power on TX1 versus frequency and over temperature

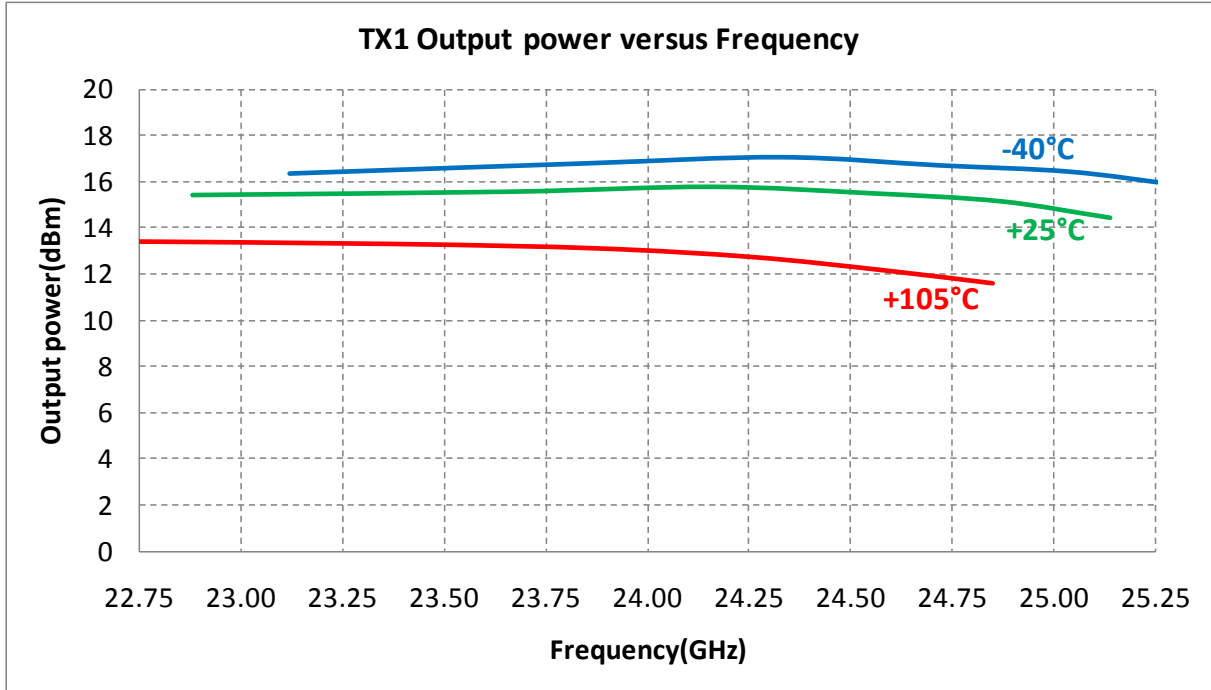

Typical Output power on TX2 versus frequency and over temperature

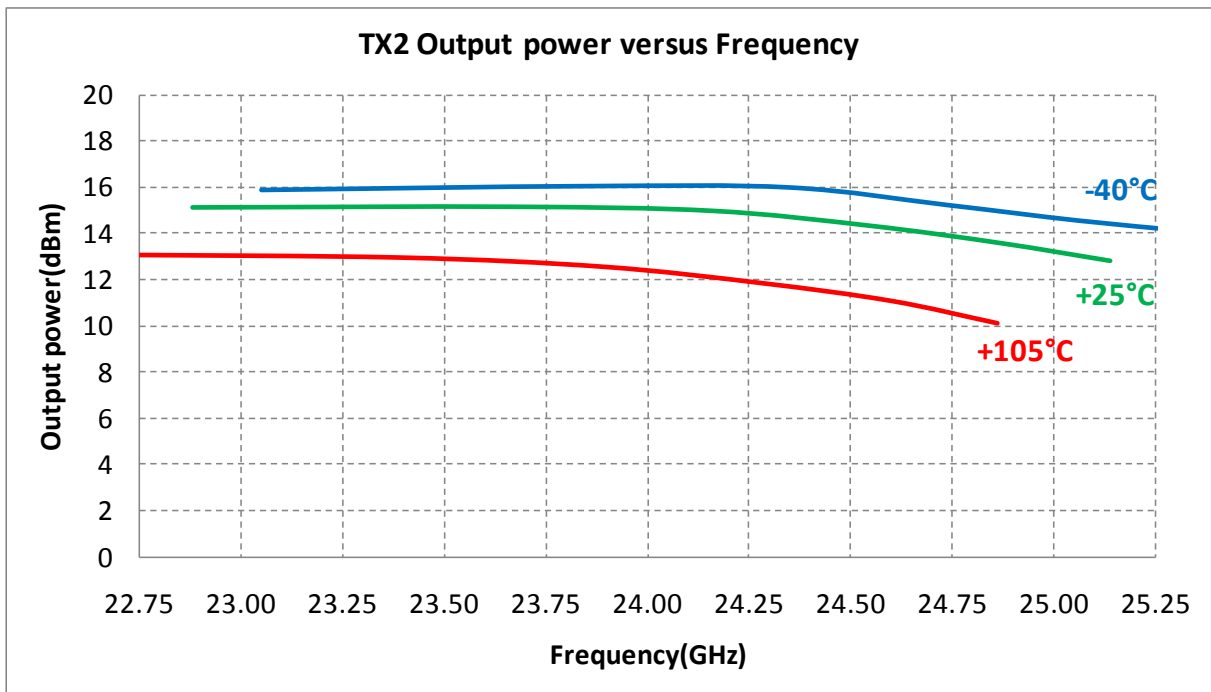

## Typical Board Measurements (QFN plan)

All supplies= +5V

### Typical TX1 Output Power versus VB21

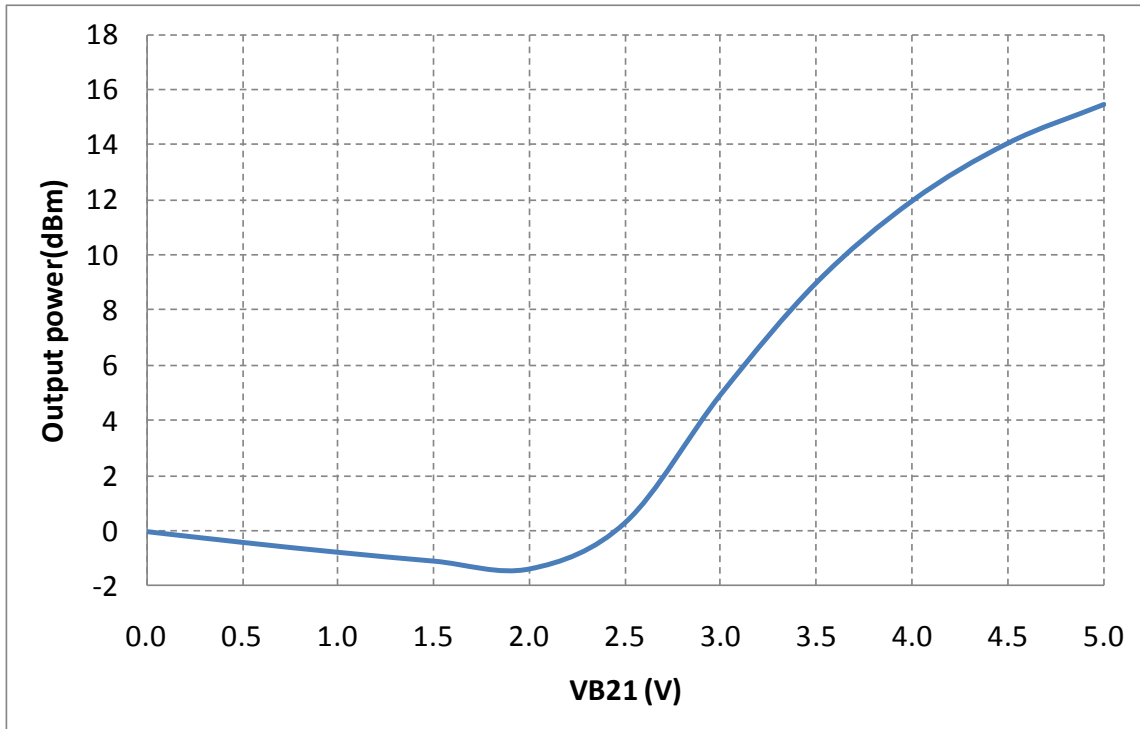

### Prescaler Current versus Supply Voltage

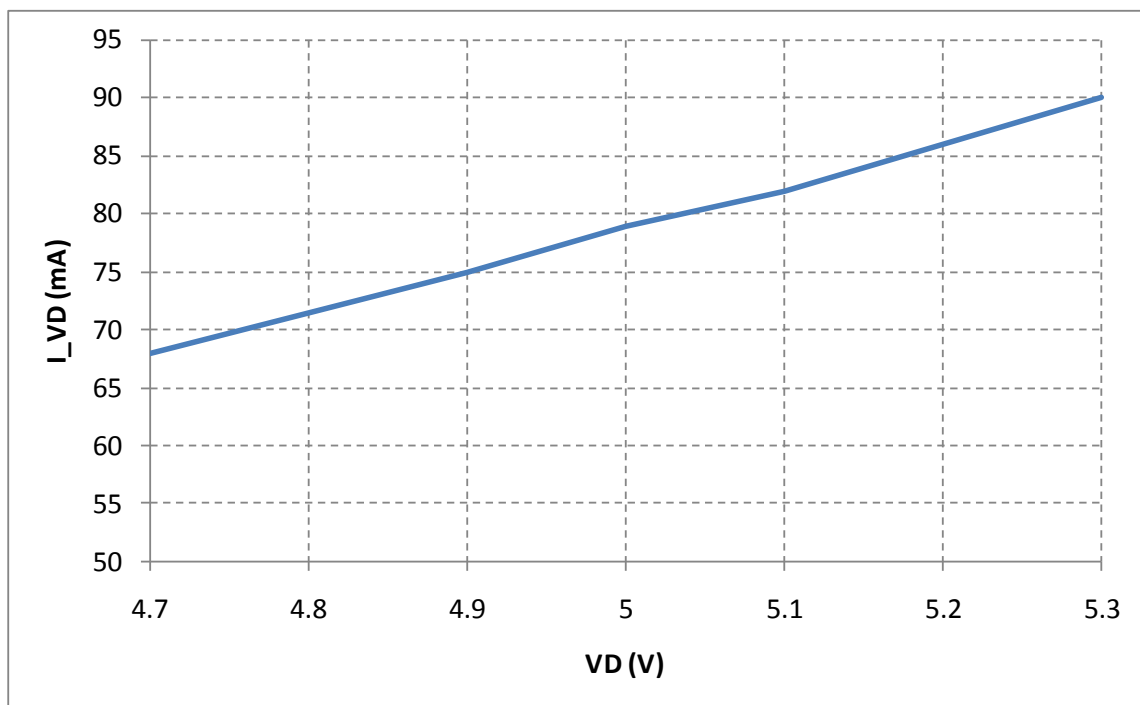



Package outline <sup>(1)</sup>

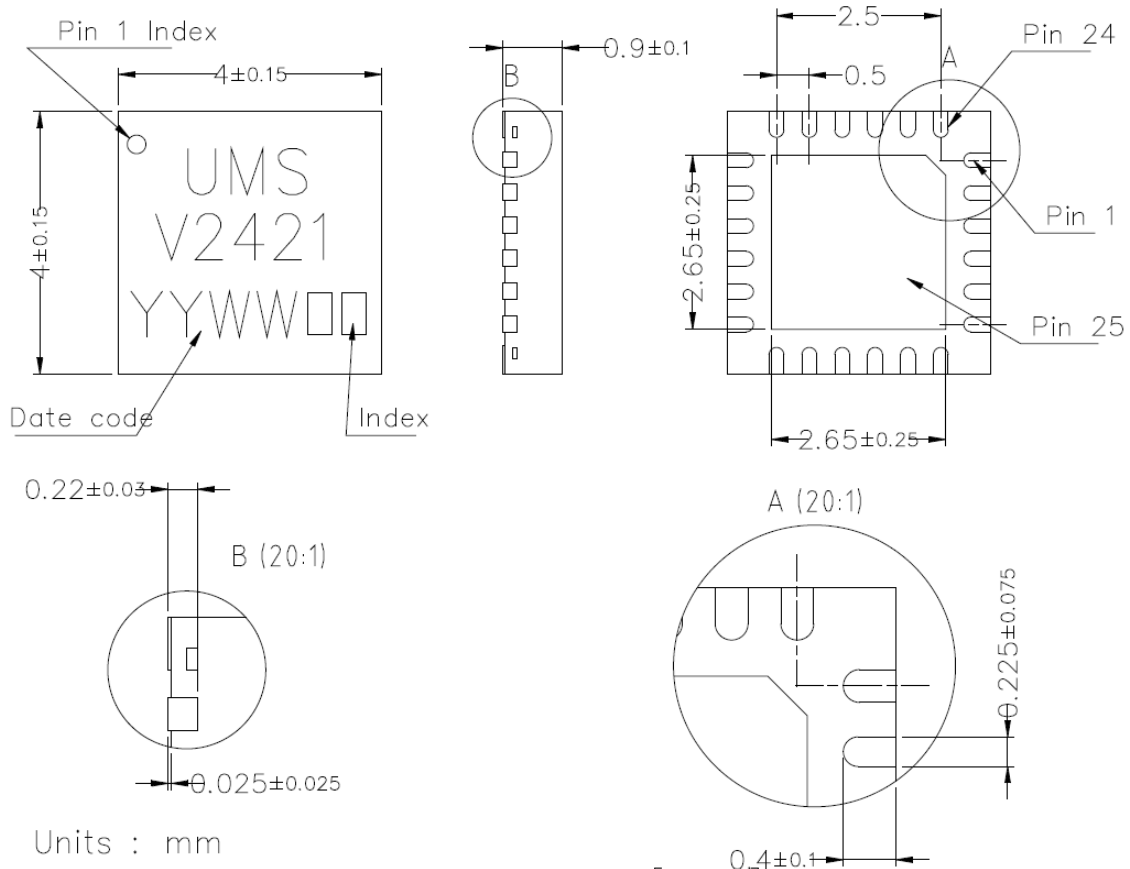

Units : mm

From the standard : JEDEC MO-220 [VGGD]

Matt tin, Lead free (Green)

Matt tin, Lead Free (Green)	1- P	9- Nc	17- Nc
Units : mm	2- Nc	10- Gnd <sup>(2)</sup>	18- VB21
From the standard : JEDEC MO-220 (VGGD)	3- VB	11- TX2	19- Gnd <sup>(2)</sup>
	4- Nc	12- Gnd <sup>(2)</sup>	20- TX1
	5- VT	13- Nc	21- Gnd <sup>(2)</sup>
25- GND	6- NC	14- M2	22- M1
	7- VCC	15- VB22	23- VB11
	8- V1	16- VB12	24- VD

<sup>(1)</sup> The package outline drawing included to this data-sheet is given for indication. Refer to the application note AN0017 (<http://www.ums-gaas.com>) for exact package dimensions.

<sup>(2)</sup> It is strongly recommended to ground all pins marked "Gnd" through the PCB board. Ensure that the PCB board is designed to provide the best possible ground to the package.

## Evaluation mother board

- Compatible with the proposed footprint.
- Based on typically Ro4003 / 8mils or equivalent.
- Using a micro-strip to coplanar transition to access the package.
- Recommended for the implementation of this product on a module board.
- Decoupling capacitors of 10nF  $\pm$ 10% are recommended for all DC accesses.
- See application note AN0017 for details.

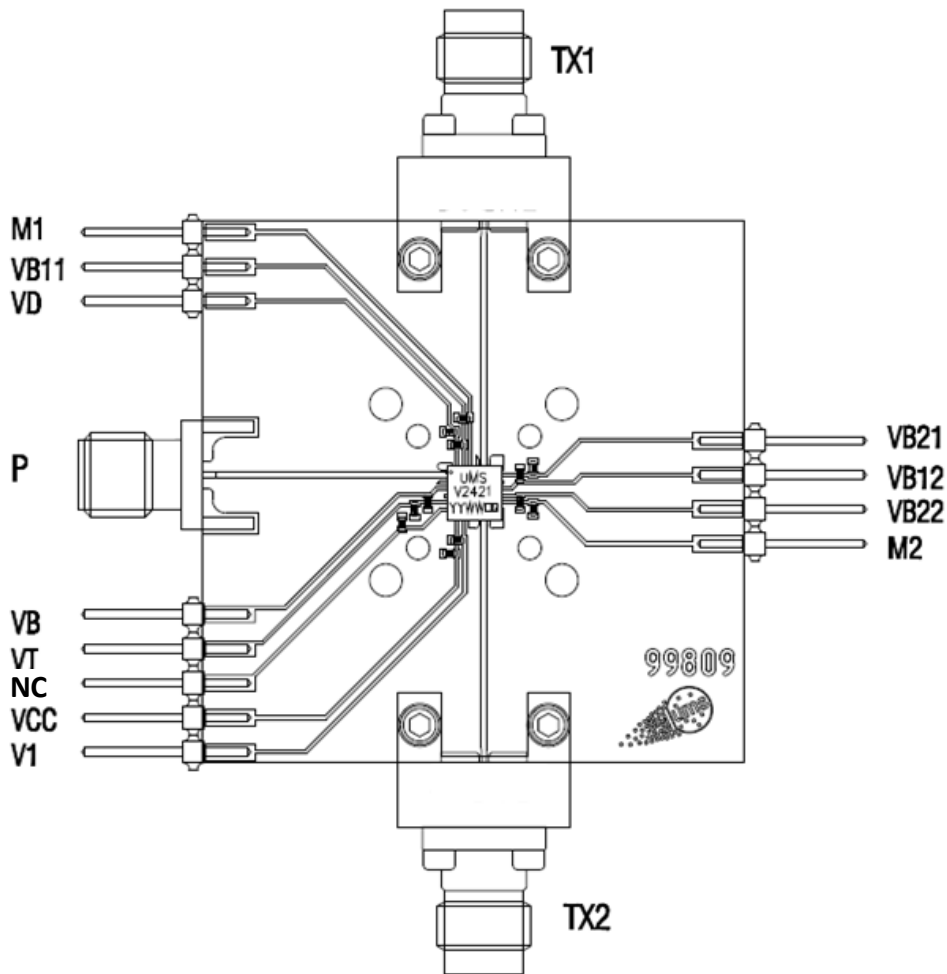

## Recommended Test Fixture PCB layout (Ref. 99809)

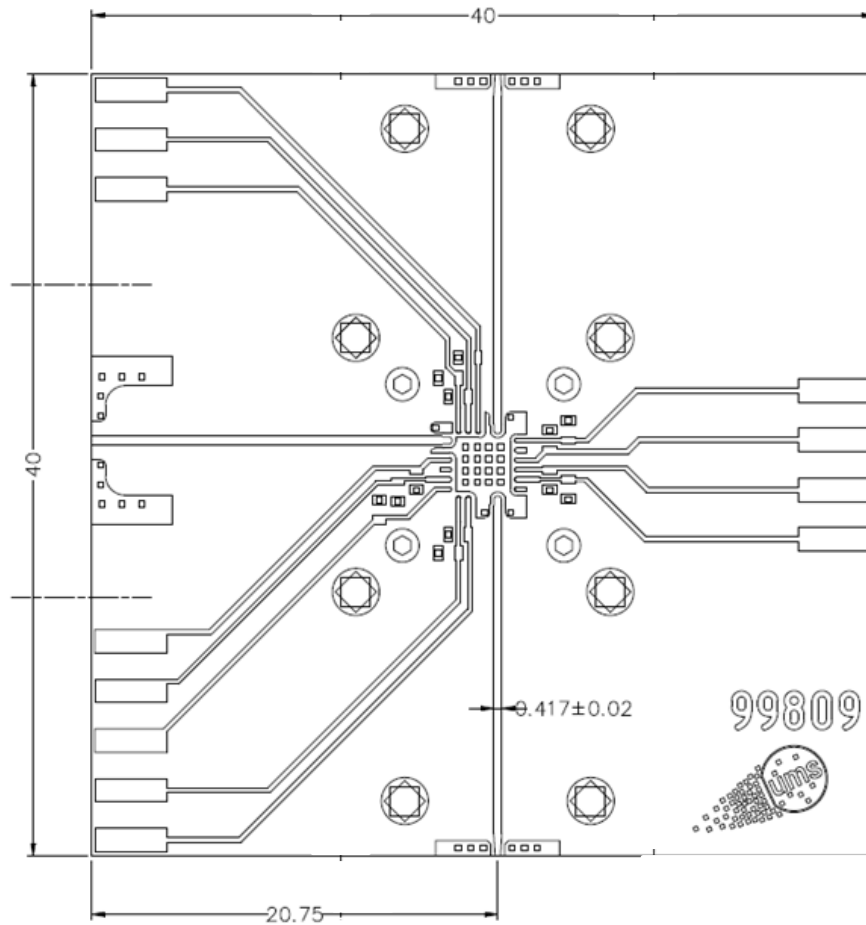
**MATERIAL**

Ro4003 ROGERS

Thickness: 0.008In (0,203mm)

2 sides Cu 17,5 $\mu$ m**FINISH**Front side: electroless Au 0.08 – 0.1 $\mu$ m over electroless Ni 5 $\mu$ mBack side: electroless Au 0.08 – 0.1 $\mu$ m over electroless Ni 5 $\mu$ m**Via holes**□ 54  $\varnothing$ 0.2 Finish○ 4  $\varnothing$ 1 Finish⊗ 8  $\varnothing$ 2 Finish

## Recommended package footprint

Refer to the application note AN0017 available at <http://www.ums-gaas.com> for package footprint recommendations.

## SMD mounting procedure

For the mounting process standard techniques involving solder paste and a suitable reflow process can be used. For further details, see application note AN0017.

## Recommended environmental management

UMS products are compliant with the regulation in particular with the directives RoHS N°2011/65 and REACH N°1907/2006. More environmental data are available in the application note AN0019 also available at <http://www.ums-gaas.com>.

## Recommended ESD management

Refer to the application note AN0020 available at <http://www.ums-gaas.com> for ESD sensitivity and handling recommendations for the UMS package products.

## Ordering Information

QFN 4x4 RoHS compliant package:	CHV2421-QDG/XY	
	Stick: XY = 20	Tape & reel: XY = 21

Information furnished is believed to be accurate and reliable. However **United Monolithic Semiconductors S.A.S.** assumes no responsibility for the consequences of use of such information nor for any infringement of patents or other rights of third parties which may result from its use. No license is granted by implication or otherwise under any patent or patent rights of **United Monolithic Semiconductors S.A.S.** Specifications mentioned in this publication are subject to change without notice. This publication supersedes and replaces all information previously supplied. **United Monolithic Semiconductors S.A.S.** products are not authorised for use as critical components in life support devices or systems without express written approval from **United Monolithic Semiconductors S.A.S.**