

S-Band 12W GaN High Power Amplifier

GaN HEMT on SiC and GaAs Monolithic Microwave Matching Circuits in SMD leadless package

Description

The CHZ8012-QJA is an S-Band Quasi-MMIC Power Amplifier based on GaN power bar and GaAs input and output matching circuits.

It is fabricated using UMS 0.25µm GaN on SiC and GaAs MMIC High Power UMS Passive technologies.

The CHZ8012-QJA is fully matched on 50 Ohms. It can be used following several operating conditions to meet system requirements. This product is dedicated to a wide range of applications, from military to commercial radar systems.

The part is proposed in low cost plastic package providing low parasitic and low thermal resistance. It is supplied in RoHS compliant SMD package.



28 leads DFN package-7x7 mm²

Main Features

- Frequency Range: 2.6-3.4GHz
- Pulsed operating mode
- High power: > 12W
- High Efficiency: > 52%
- DC bias: Vd up to 30Volt
- Low cost package: 28L-DFN 7x7mm²

V_{DS} = 26V, I_{D_Q} = 180mA, Freq = 3GHz
Pulsed mode (400µs, 15%), 25°C

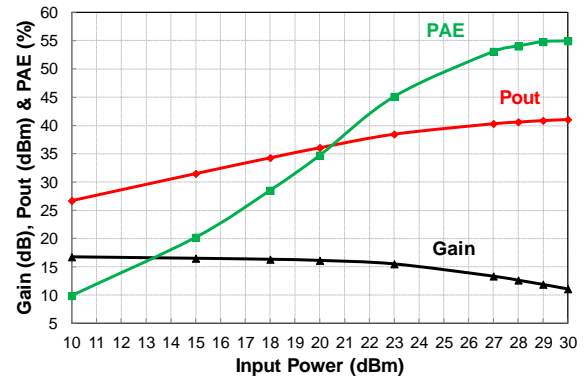

Performances on S-band Evaluation Board

Main Electrical Characteristics

T_{case}= +25°C, Pulsed mode, V_{DS}=26V, I_{D_Q}=180mA

Symbol	Parameter	Min	Typ	Max	Unit
Freq	Frequency range	2.6		3.4	GHz
Gain	Linear Gain		16.5		dB
Pout	Saturated Output Power		12		W
PAE	Max Power Added Efficiency		55		%

Recommended Operating Ratings

$T_{case} = +25^{\circ}C$

Symbol	Parameter	Min	Typ	Max	Unit	Conditions
V_{DS}	Drain to Source Voltage			30	V	
V_{GS}	Gate to Source Voltage		-3.5		V	$V_{DS}=30V$, $I_{D_Q}=0.18A$
I_{D_Q}	Quiescent Drain Current		0.18	0.41 ⁽¹⁾	A	$V_{DS} =30V$
I_{D_MAX}	Drain Current		0.95	⁽¹⁾	A	$V_{DS}=30V$, compressed mode
I_{G_MAX}	Gate Current in forward mode		0	14	mA	DC or Compressed mode
Pw	Pulse width		0.5	1	ms	Pulse width
DC	Duty Cycle		10	15	%	Duty Cycle
T_{case}	Case Operating Temperature	-30		100	$^{\circ}C$	⁽¹⁾
T_{j_MAX}	Junction temperature			200	$^{\circ}C$	⁽¹⁾

⁽¹⁾ Power dissipation must be considered.

Electrical Characteristics

$T_{case} = +25^{\circ}C$, RF Pulsed mode (400 μ s / 15%), Class AB ($I_{D_Q}=180mA$)

Symbol	Parameter	Min	Typ	Max	Unit
Fop	Operating frequency range	2.6		3.4	GHz
Gain	Small Signal Gain		16.5		dB
P_{sat}	Saturated Output Power		41		dBm
PAE	Power Added Efficiency		54		%
G_{PAE_max}	Associated gain at maximum PAE		11		dB
V_{DS}	Biassing Drain Voltage		26		V
V_{GS}	Biassing Gate Voltage		-3.5		V
I_{D_Q}	Quiescent drain current		180		mA
RI_{in}	Input Return Loss		-11.4		dB
RI_{out}	Output Return Loss		-8.5		dB

These values are representative of on board measurements as defined on the drawing in paragraph "Evaluation Board".

Electrical Characteristics

$T_{case} = +25^{\circ}\text{C}$, RF Pulsed mode (400 μs / 15%), Class B ($I_{D_Q} \sim 0\text{mA}$)

Symbol	Parameter	Min	Typ	Max	Unit
F _{op}	Operating frequency range	2.6		3.4	GHz
P _{sat}	Saturated Output Power		41		dBm
PAE	Power Added Efficiency		60		%
G _{PAE_max}	Associated gain at maximum PAE		11		dB
V _{DS}	Biassing Drain Voltage		26		V
V _{GS}	Biassing Gate Voltage		-3,8		V
RL _{in}	Input Return Loss @ maximum PAE		-13		dB

These values are representative of on board measurements as defined on the drawing in paragraph "Evaluation Board".

Absolute Maximum Ratings ⁽¹⁾ ⁽²⁾ ⁽³⁾

Symbol	Parameter	Rating	Unit	Note
V _{DS}	Drain-Source Biassing Voltage	-0.5, +35	V	
V _{GS_Q}	Gate-Source Biassing Voltage	-15, -1	V	(4) (5)
I _{G_MAX}	Maximum Gate Current (forward mode; 25°C)	30	mA	(4)
I _{G_MIN}	Minimum Gate Current (reverse mode; 25°C)	-2	mA	
P _{IN}	Maximum Input Power	32	dBm	(4) (5)
P _w	Pulse width	3	ms	(4)
DC	Duty Cycle	30	%	(4)
T _j	Junction temperature	230	°C	
T _{STG}	Storage Temperature	-55 to +125	°C	
T _{Case}	Case Operating Temperature	-40 to +110	°C	(4)

(1) Operation of this device above anyone of these parameters may cause permanent damage.

(2) Duration < 1s.

(3) The given values must not be exceeded at the same time even momentarily for any parameter, since each parameter is independent from each other. Otherwise deterioration or destruction of the device may take place.

(4) Max junction temperature must be considered

(5) Limited by I_{G_MAX} & I_{G_MIN} values.

Biassing procedure

1. Bias power bar gate voltage at V_{GS} close to V_{pinch-off} (Typically: V_{GS} ≈ -5V)
2. Apply V_{DS} bias voltage (Typically: V_{DS} = 26V)
3. Increase V_{GS} up to quiescent bias drain current I_{D_Q}

The quiescent current steady state must be carefully controlled as it is influenced by the operating mode, the temperature and the overall thermal resistance.

A drain current control is recommended on the biassing network.

Device thermal performances

The thermal performances of the device are based on UMS rules to evaluate the junction temperature (T_j). This temperature is defined as the peak temperature in the channel area.

This same procedure is the basis for junction temperature evaluation of the samples used to derive the Median lifetime and activation energy for the particular technology on which the CHZ8012-QJA is fabricated (GaN Power PHEMT 0.25 μ m).

The temperature T_{case} is defined as the package back side temperature

The thermal resistance (R_{th}) is considered in pulsed mode as given in the table. The device assembly must be adapted to the operating mode, especially for SMD components which are very dependent on PCB characteristics. Thermal analysis is recommended. More information is available on request.

Parameters	Symbol	Conditions (Package)	Value	Unit
Typical Thermal Resistance (junction-case)	R_{th}	$T_{case} = 95^{\circ}C$ Pin=29dBm Total dissipated power=9.5W (Saturated operating mode)	4.2 (global device)	$^{\circ}C/W$
Junction Temperature	T_j	Pulsed mode: 400 μ s/15%	135	$^{\circ}C$

Median Life Time versus Junction Temperature

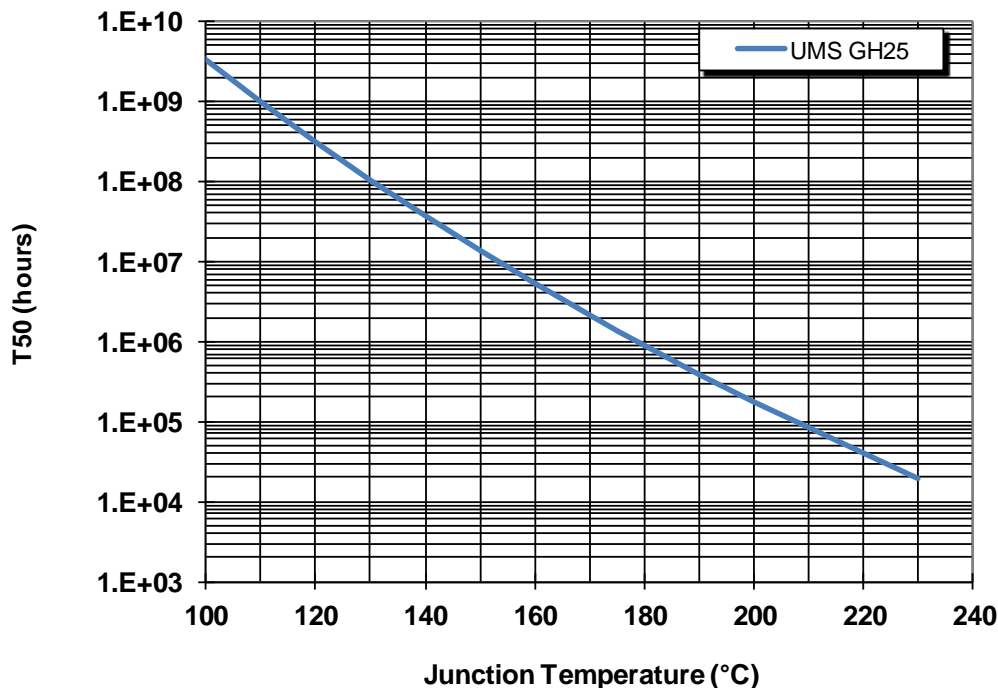

Typical S-parameters Measurements

Calibration and measurements are done on the connector reference accesses of the demonstration boards.

$T_{case} = +25^{\circ}C$, $V_{DS}=26V$, $I_{D,Q}=180mA$.

Pulsed input power : 400 μ s / 15%

S21, S11 & S22 versus Frequency

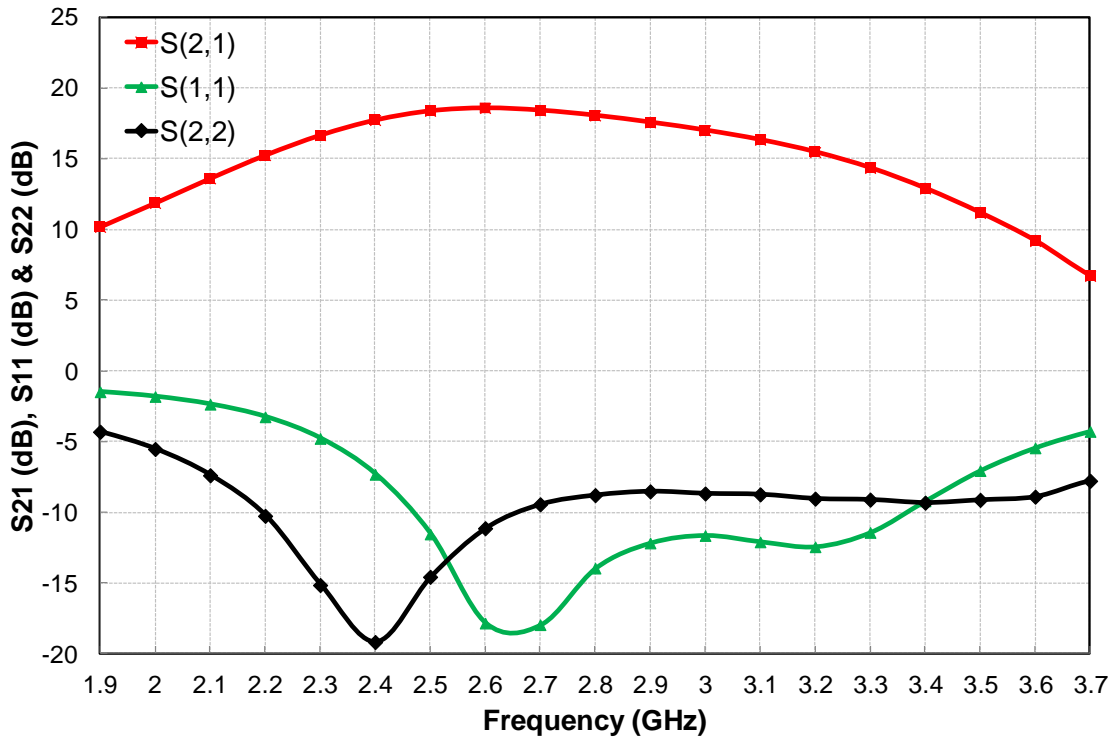

Typical Performance

Power Measurements results at package IN/OUT reference.

$T_{case} = +25^{\circ}C$, $V_{DS} = +26V$, $I_{D,Q} = 180mA$ (Class AB)

Pulsed input power : 400 μ s / 15%

Id, Gain, Pout & PAE versus Pin @ 3GHz

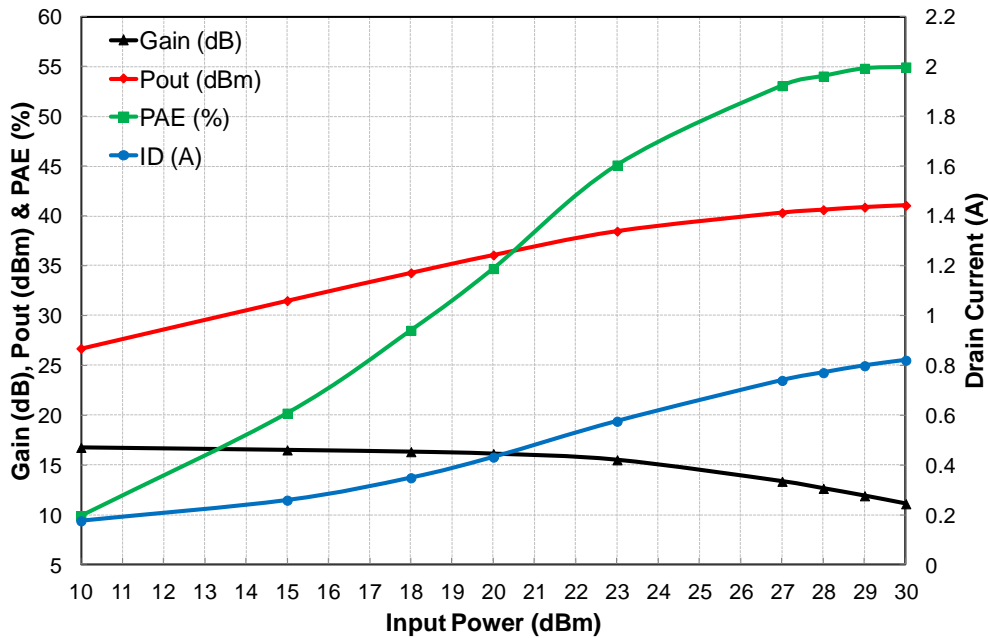

$T_{case} = +25^{\circ}C$, $V_{DS} = +26V$, $I_{D,Q} = 0mA$ (Class B)

Pulsed input power: 400 μ s / 15%

Id, Gain, Pout & PAE versus Pin @ 3GHz

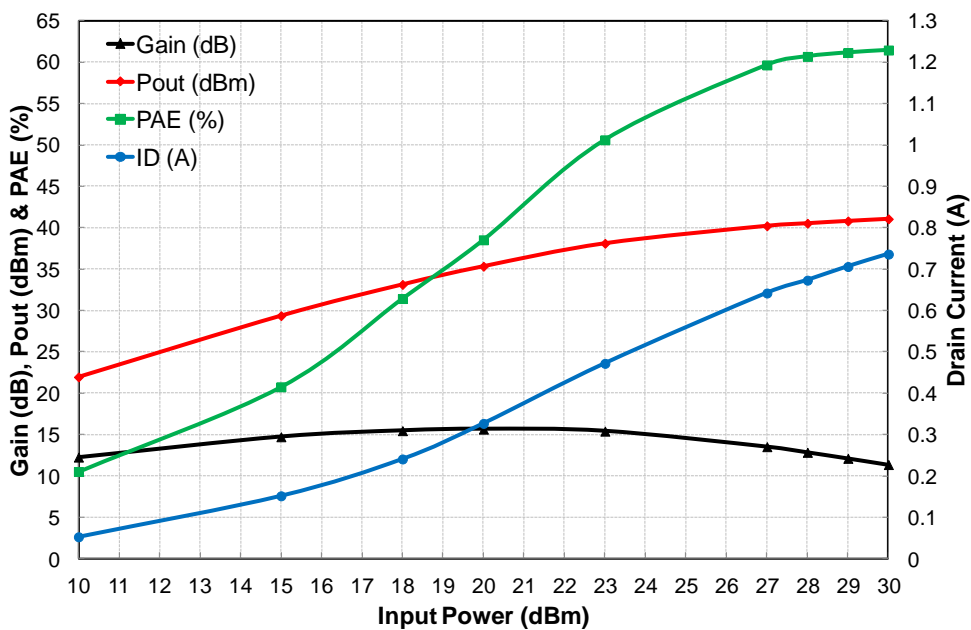

Typical Performance

Power Measurements results at package IN/OUT reference.

$T_{case} = +25^{\circ}C$, $V_{DS} = +26V$, $I_{D_Q} = 180mA$ (Class AB)

Pulsed input power : 400 μ s / 15%

Linear Gain, Pout & PAE & Associated Gain @ Pin=30dBm versus Frequency

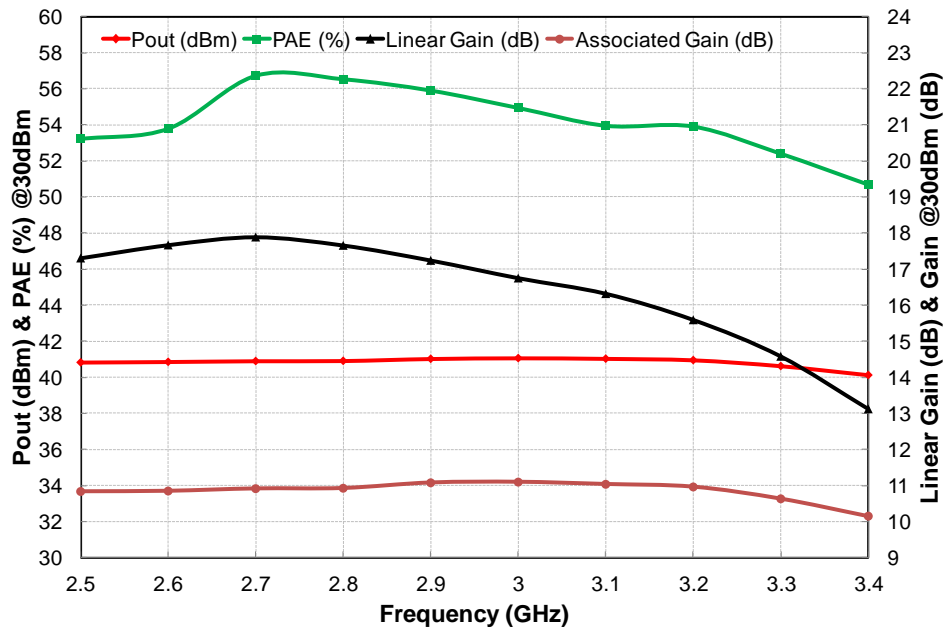

$T_{case} = +25^{\circ}C$, $V_{DS} = +26V$, $I_{D_Q} = 0mA$ (Class B)

Pulsed input power : 400 μ s / 15%

Pout, PAE & Associated Gain versus Frequency @ Pin=30dBm

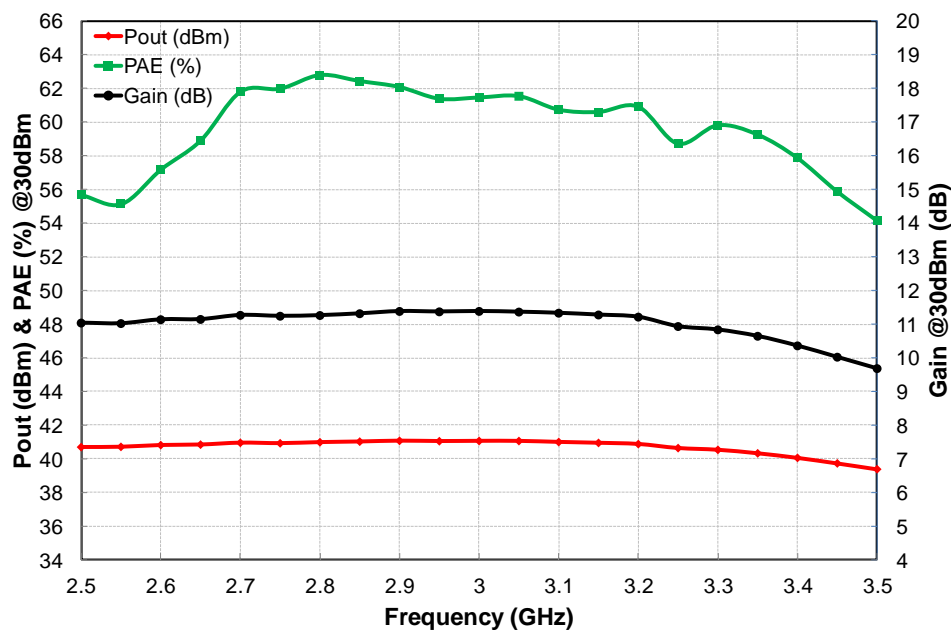

Typical Performance in Temperature

Power Measurements results at package IN/OUT reference.

$T_{case} = -30^{\circ}C, +25^{\circ}C, +85^{\circ}C, V_{DS}=26V, V_{GS}=constant (I_{D_Q}=180mA @ 25^{\circ}C - \text{Class AB})$

Pulsed input power : 400 μ s / 15%

Pout & PAE versus Frequency and Temperature @ Pin=30dBm

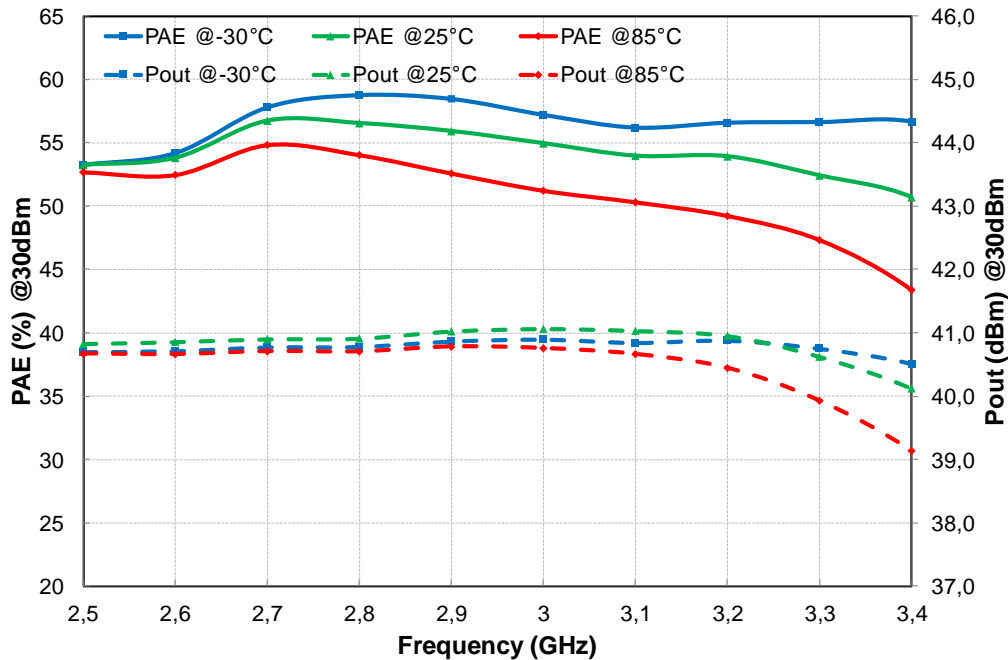

$T_{case} = 0^{\circ}C, +25^{\circ}C, +95^{\circ}C, V_{DS}=26V, V_{GS}=constant (I_{D_Q}=0mA @ 25^{\circ}C - \text{Class B})$

Pulsed input power : 400 μ s / 15%

Pout & PAE versus Frequency and Temperature @ Pin=30dBm

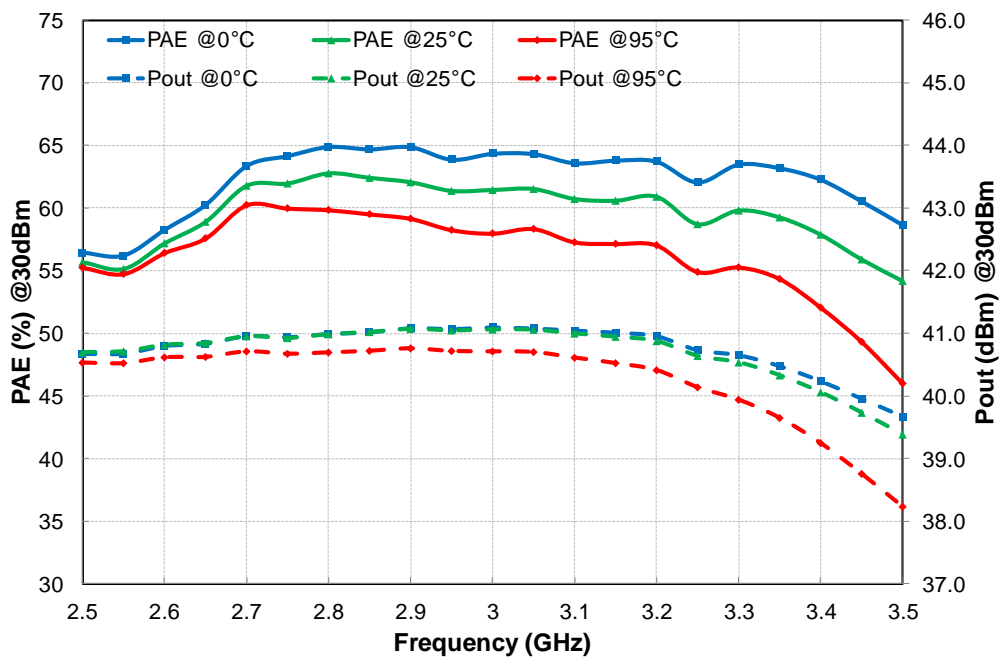

Typical Performance in Temperature

Power Measurements results at package IN/OUT reference

T_{case} = -30°C, +25°C, +85°C, V_{DS}=26V, V_{GS}=constant (I_{D,Q}=180mA @ 25°C - Class AB)

Pulsed input power : 400µs / 15%

Gain, Pout & PAE versus Pin and Temperature @ 3GHz

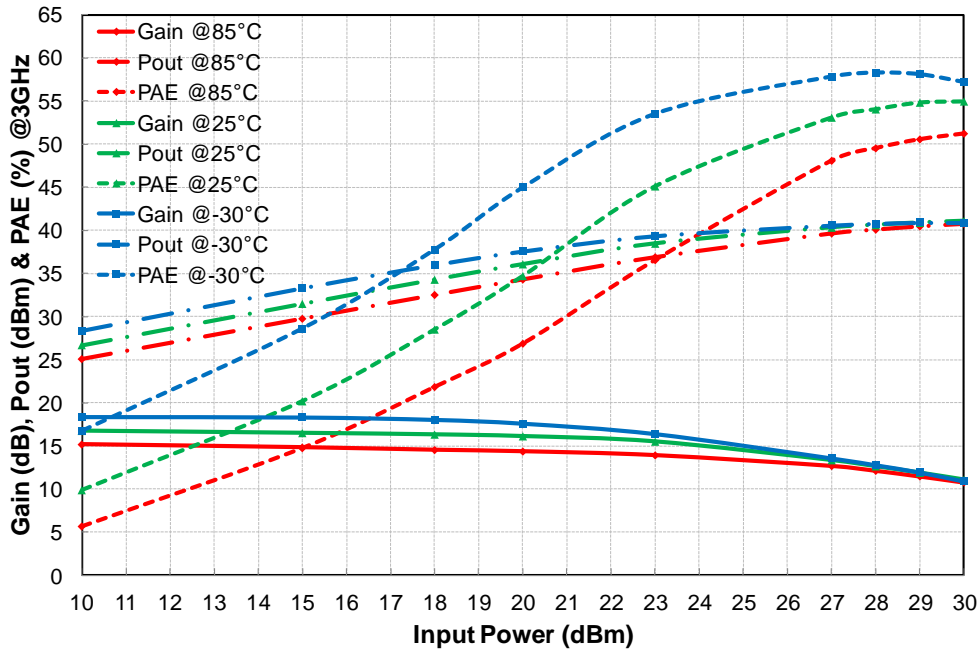

T_{case} = 0°C, +25°C, +95°C, V_{DS}=26V, V_{GS}=constant (I_{D,Q}=0mA @ 25°C - Class B)

Pulsed input power : 400µs / 15%

Gain, Pout & PAE versus Pin and Temperature @ 3GHz

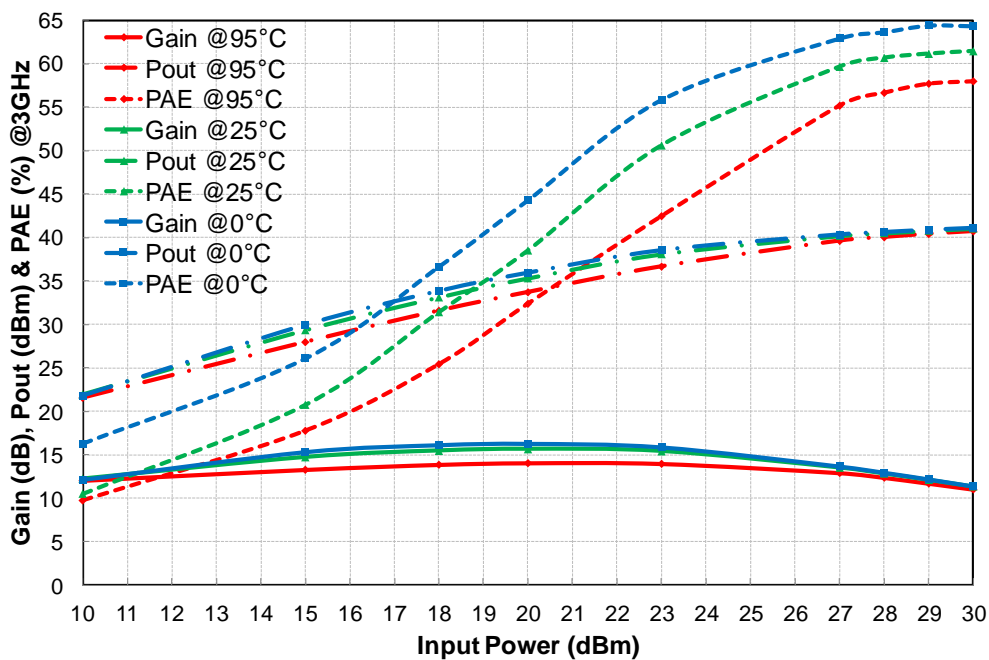

Package outline

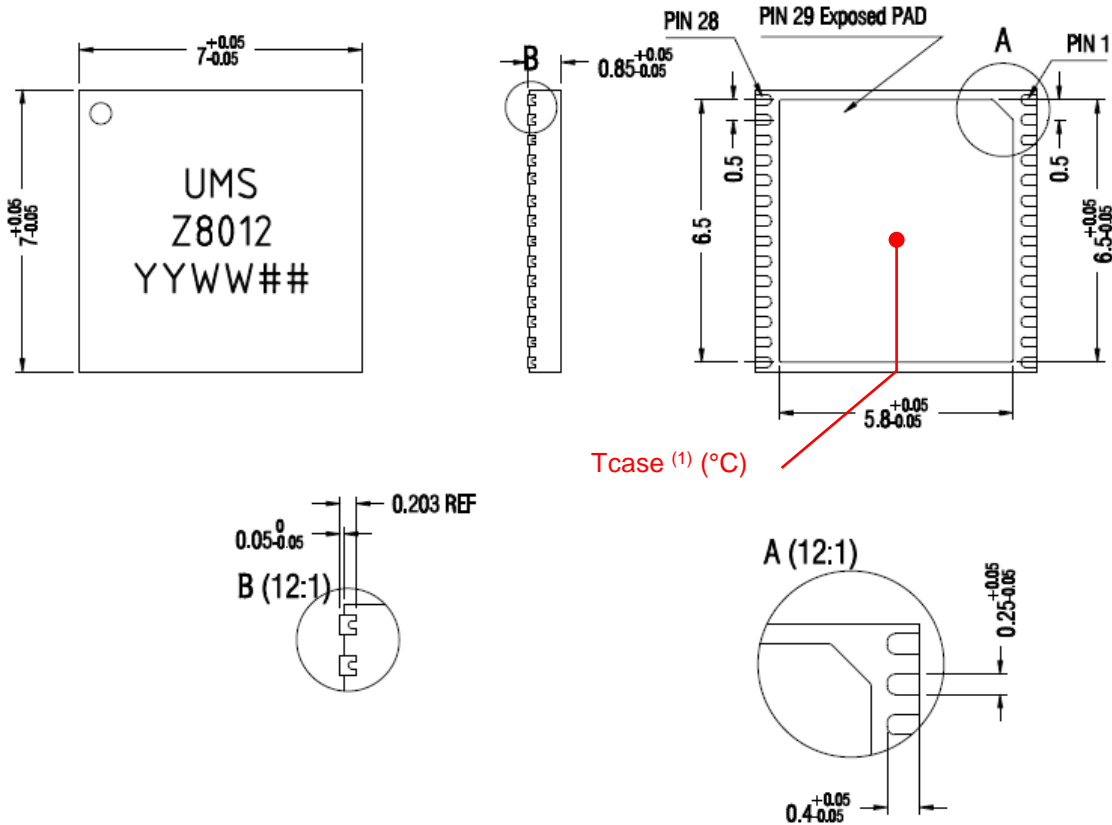

Tcase⁽¹⁾ (°C)

Finish : NiPdAu Units : mm	1-NC	8-NC	15-NC	22-RF OUT	29- GND ⁽²⁾
	2-NC	9-GND ⁽²⁾	16-NC	23-NC	
	3-NC	10-VG	17-NC	24-GND ⁽²⁾	
	4-VG	11-NC	18-NC	25-VD	
	5-GND ⁽²⁾	12-NC	19-NC	26-NC	
	6-NC	13-NC	20-GND ⁽²⁾	27-NC	
	7-RF IN	14-NC	21-NC	28-NC	

⁽¹⁾ Tcase locates the reference point used to monitor the device temperature. This point has been taken at the device / system interface to ease system thermal design.

⁽²⁾ It is strongly recommended to ground all pins marked "GND" through the PCB board. Ensure that the PCB board is designed to provide the best possible ground to the package.

Evaluation board (Ref. 61503235)

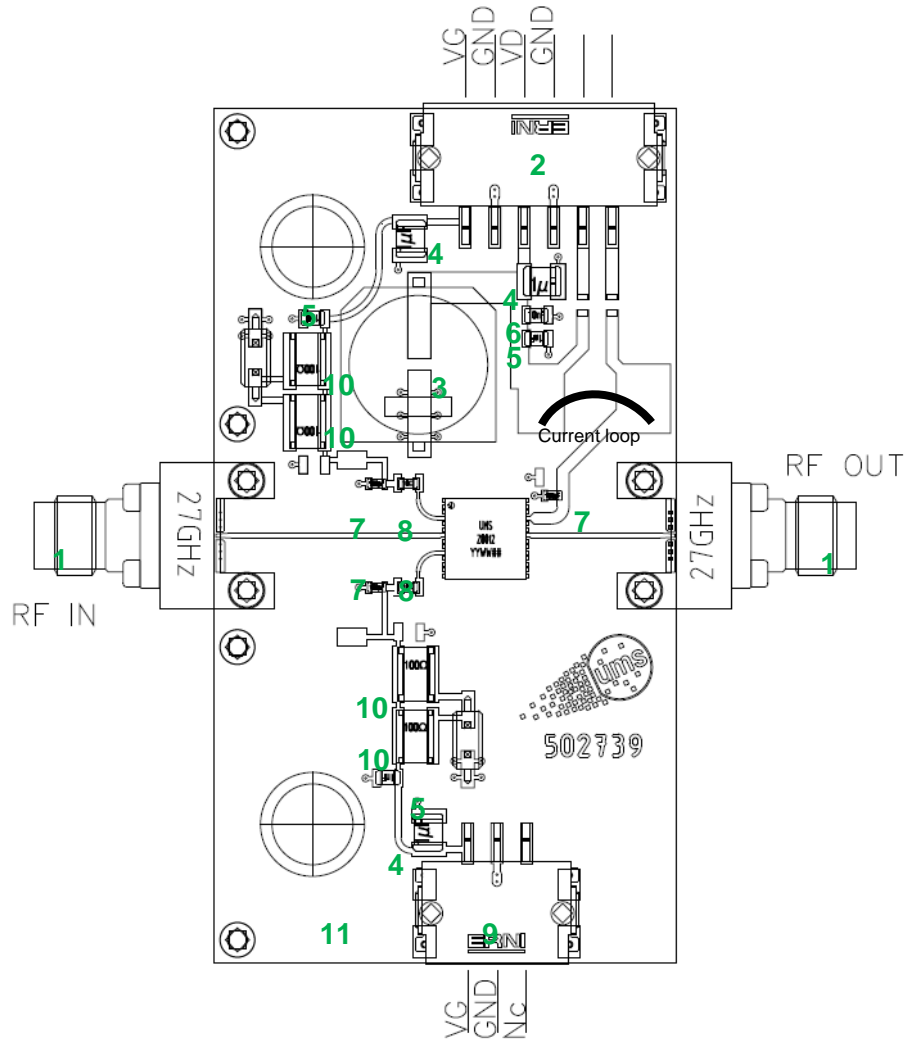

Demonstration Amplifier Bill of Materials (Ref. 61503235)

Designation	Component	Value - Description	Qty
1	RF Connector	RF-SMA DC-27GHz	2
2	DC Connector	CMS 6cts	1
3	Capacitor	68µF +/-20%. 100V	1
4	Capacitor	1µF +/-10%. 1210 100V	3
5	Capacitor	1nF +/-5%. 0805 100V	3
6	Capacitor	10nF +/-10%. 0805 100V	1
7	Capacitor	100pF +/-5%. 0603 250V	3
8	Resistor	10Ω +/-1%. 0603 0.1W	2
9	DC Connector	CMS 3cts	1
10	Resistor	100Ω +/-1%. RCL 1218 1W	4
11	PCB	TACONIC RF35P-0080-CH/Cu1/ Thickness=0.008in (0.203mm)/ Bottom Copper layer: 1mm	1

DC Schematic (Ref. 61503235)

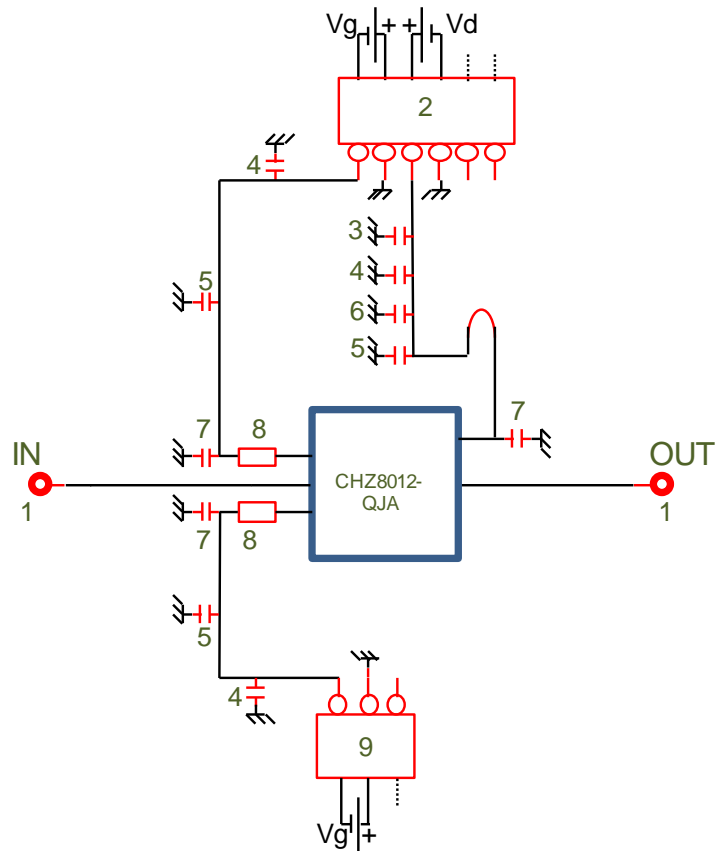

The CHZ8012-QJA does not include any high value decoupling capacitor in the package. Therefore, it is mandatory to provide a good external DC decoupling on the PCB board, as close as possible to the package (See paragraph "Evaluation board").

Demonstration Amplifier Circuit (Ref. 61503235)

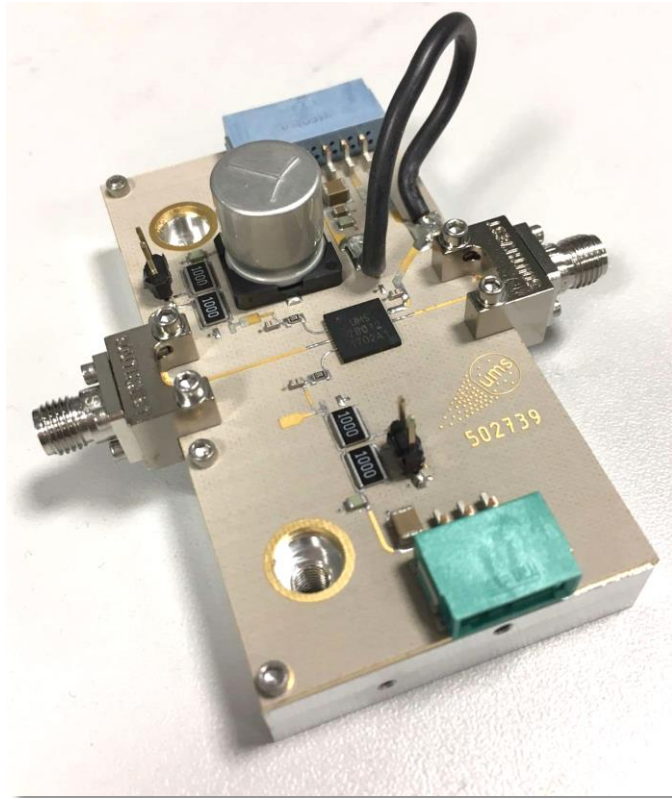

ESD sensitivity

Standard	Value
JEDEC JESD22-A114	HBM Class 1A ($\leq 350V$)
JEDEC JESD22-A115	MM Class A ($\leq 150V$)

Package Information

Parameter	Value
Package body material	RoHS-compliant
	Low stress Injection Molded Plastic
Lead finish	NiPdAu
MSL Rating	MSL3 (IPC/JEDEC J-STD-020)

Qualification domain

This part is qualified according to UMS standards including uHAST stress (Accelerated Moisture Resistance-Unbiased HAST) based on JEDEC JESD22-A118.

Recommended package footprint

Refer to the application note AN0017 available at <https://www.ums-rf.com> for package footprint recommendations.

SMD mounting procedure

For the mounting process, standard techniques involving solder paste and a suitable reflow process can be used. For further details, see application note AN0017.

Recommended environmental management

UMS products are compliant with the regulation in particular with the directives RoHS N°2011/65 and REACH N°1907/2006. More environmental data are available in the application note AN0019 also available at <https://www.ums-rf.com>.

Recommended ESD management

Refer to the application note AN0020 available at <https://www.ums-rf.com> for ESD sensitivity and handling recommendations for the UMS package products.

Ordering Information

DFN 7x7 package:

CHZ8012-QJA/XY

Stick: XY = 20

Information furnished is believed to be accurate and reliable. However **United Monolithic Semiconductors S.A.S.** assumes no responsibility for the consequences of use of such information nor for any infringement of patents or other rights of third parties which may result from its use. No license is granted by implication or otherwise under any patent or patent rights of **United Monolithic Semiconductors S.A.S.** Specifications mentioned in this publication are subject to change without notice. This publication supersedes and replaces all information previously supplied. **United Monolithic Semiconductors S.A.S.** products are not authorised for use as critical components in life support devices or systems without express written approval from **United Monolithic Semiconductors S.A.S.**