

Features

1. SMD type chip inductors utilizing monolithic structure provide highly reliable surface mount applications.
2. Superior Q characteristics is guaranteed over the wide frequency range to allow high frequency applications.
3. Terminal electrode has excellent solder heat resistance for soldering.

Applications

1. RF module of telecommunication products.
 - Cellular phone, Cordless telephone, Pagers etc.
2. GSM Phone, PCS Phone.
3. Computer communications, Radar detectors.
4. Automotive electronics, Keyless remote.

Ordering Information

$\frac{CI}{(1)}$ - $\frac{B}{(2)}$ $\frac{1608}{(3)}$ - $\frac{120}{(4)}$ - $\frac{K}{(5)}$ $\frac{J}{(6)}$ $\frac{T}{(7)}$

(1) Series

(2) Material & design

(3) Dimensions

The first two digits : length(mm)
The last two digits : width(mm)

(4) Inductance

The first two digits are significant.
The last digit is the number of zeros following.
N : a decimal point placed between first two digits

(5) Tolerance

S : $\pm 0.3nH$
J : $\pm 5\%$
K : $\pm 10\%$

(6) Termination

J : Nickel barrier

Packing

B : Bulk Packing
T : Tape & Reel (178mm [7inches])
L : Tape & Reel (254mm [10inches])

Shape and Dimensions

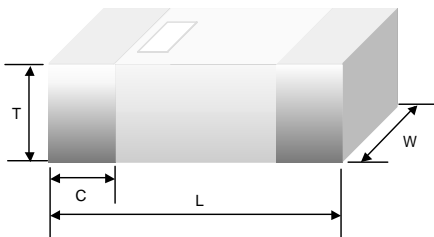

unit : mm [inches]

Type	L	W	T	C
CI- 1005-	1.0 \pm 0.10 [.039 \pm .004]	0.5 \pm 0.10 [.020 \pm .004]	0.5 \pm 0.10 [.020 \pm .004]	0.20 \pm 0.10 [.008 \pm .004]
CI- 1608-	1.6 \pm 0.15 [.063 \pm .006]	0.8 \pm 0.15 [.031 \pm .006]	0.8 \pm 0.15 [.031 \pm .006]	0.30 \pm 0.20 [.012 \pm .008]
CI- 2012-	2.0 \pm 0.2 [.079 \pm .008]	1.25 \pm 0.2 [.049 \pm .008]	1.0 \pm 0.2 [.047 \pm .008]	0.50 \pm 0.30 [.020 \pm .012]

The polarity mark can be provided upon customer's request.

Specifications

CI1005

Part No.	Inductance		Q 100MHz min.	Q 800MHz min.	Q 1.8GHz min.	SRF (MHz)		DCR (mΩ) max.	Rated current (mA) max
	nH	Tolerance				min.	typ.		
CI-B1005-10N	1.0	±0.3nH	8	20	26	6000	13000	100	300
CI-B1005-12N	1.2		8	20	26	6000	10000	120	300
CI-B1005-15N	1.5		8	20	30	6000	10000	120	300
CI-B1005-18N	1.8		8	22	35	6000	9500	140	300
CI-B1005-22N	2.2		8	22	35	6000	9000	160	300
CI-B1005-27N	2.7		8	22	35	6000	9000	200	300
CI-B1005-33N	3.3		8	22	35	6000	8000	220	300
CI-B1005-39N	3.9		8	22	30	4000	6500	250	300
CI-B1005-47N	4.7		8	22	30	4000	5000	280	300
CI-B1005-56N	5.6		8	22	28	4000	5000	300	300
CI-B1005-68N	6.8		± 5%	8	22	28	3900	4400	350
CI-B1005-82N	8.2	8		20	28	3600	4000	400	250
CI-B1005-100	10.0	8		20	24	3200	3500	450	250
CI-B1005-120	12	8		20	24	2700	3500	500	200
CI-B1005-150	15	8		20	20	2300	3000	550	200
CI-B1005-180	18	8		20	15	2100	2600	650	200
CI-B1005-220	22	8		20	13	1900	2200	800	200
CI-B1005-270	27	8		17	-	1600	1900	900	200
CI-B1005-330	33	8		16	-	1300	1700	1100	200
CI-B1005-390	39	8		16	-	1200	1600	1200	100
CI-B1005-470	47	8		10	-	1000	1300	1300	100
CI-B1005-560	56	8		-	-	750	900	1400	100
CI-B1005-680	68	8		-	-	700	800	1400	100
CI-B1005-820	82	8		-	-	600	700	1600	100
CI-B1005-101	100	8		-	-	350	650	2000	100

* SRF : Self-Resonant Frequency.

* DCR : DC Resistance

Electrical characteristics

Inductance characteristics

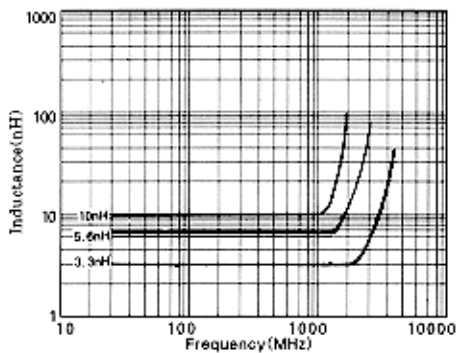

Q characteristics

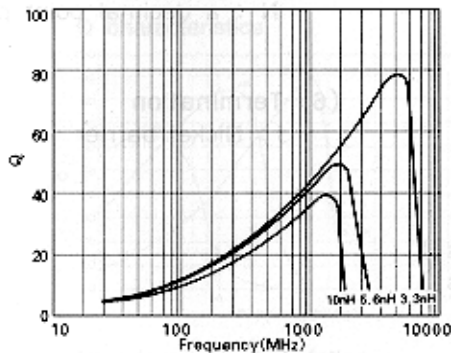

CI1608

Part No.	Inductance		Q min.	L, Q test frequency (MHz)	SRF (MHz)		DCR (m) max.	Rated current (mA) max
	nH	Tolerance			min.	typ.		
CI-B1608-10N	1.0	±0.3nH	8	100	4000	13000	100	300
CI-B1608-12N	1.2		8	100	4000	13000	100	300
CI-B1608-15N	1.5		8	100	4000	10000	100	300
CI-B1608-18N	1.8		8	100	3800	10000	120	300
CI-B1608-22N	2.2		8	100	3600	10000	160	300
CI-B1608-27N	2.7		8	100	3400	8000	200	300
CI-B1608-33N	3.3		10	100	3200	6000	220	300
CI-B1608-39N	3.9		10	100	3000	6000	250	300
CI-B1608-47N	4.7		10	100	2800	5000	280	300
CI-B1608-56N	5.6		10	100	2700	5000	290	300
CI-B1608-68N	6.8	± 5% ± 10%	10	100	2600	4000	300	300
CI-B1608-82N	8.2		10	100	2200	4000	330	300
CI-B1608-100	10		10	100	1800	3000	350	300
CI-B1608-120	12		10	100	1650	2500	400	300
CI-B1608-150	15		10	100	1350	2000	450	300
CI-B1608-180	18		10	100	1350	2000	500	300
CI-B1608-220	22		10	100	1100	1800	550	300
CI-B1608-270	27		10	100	1100	1600	600	300
CI-B1608-330	33		10	100	1000	1400	650	300
CI-B1608-390	39		10	100	900	1300	700	300
CI-B1608-470	47		10	100	800	1300	900	300
CI-B1608-560	56		10	100	750	1100	1000	300
CI-B1608-680	68		10	100	700	1000	1200	300
CI-B1608-820	82		10	100	600	850	1500	300
CI-B1608-101	100		10	100	600	750	1700	300
CI-B1608-121	120		8	50	500	650	2000	250
CI-B1608-151	150		8	50	500	600	2400	200
CI-B1608-181	180		8	50	400	500	2700	200
CI-B1608-221	220	8	50	350	500	2800	200	
CI-B1608-271	270	8	50	300	450	3100	200	

* SRF : Self-Resonant Frequency.

* DCR : DC Resistance

Electrical characteristics

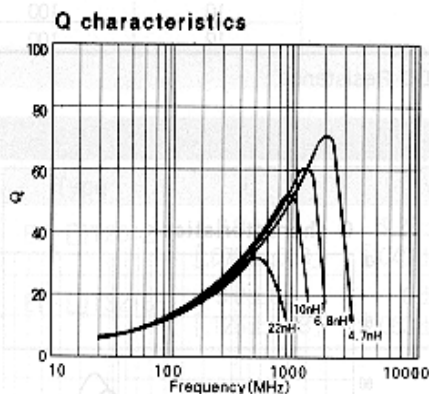
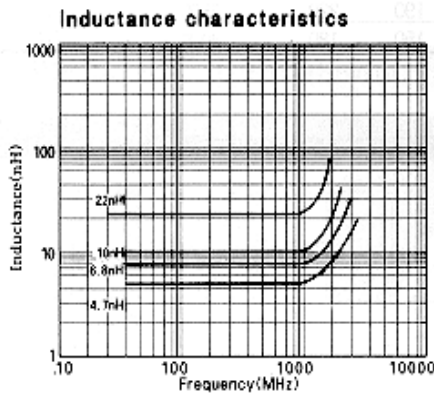

CI2012

Part No.	Inductance		Q min.	L, Q test frequency(MHz)	SRF (MHz)		DCR (m) max.	Rated current (mA) max.
	nH	Tolerance			min.	typ.		
CI-B2012-10N	1.0	±0.3nH	10	100	4000	12000	100	300
CI-B2012-12N	1.2		10	100	4000	10000	100	300
CI-B2012-15N	1.5		10	100	4000	10000	100	300
CI-B2012-18N	1.8		10	100	4000	8000	100	300
CI-B2012-22N	2.2		10	100	3800	8000	100	300
CI-B2012-27N	2.7		10	100	3600	6000	100	300
CI-B2012-33N	3.3		10	100	3400	6000	130	300
CI-B2012-39N	3.9		10	100	3200	5400	150	300
CI-B2012-47N	4.7		10	100	3000	4500	200	300
CI-B2012-56N	5.6		10	100	2800	4000	230	300
CI-B2012-68N	6.8	± 5% ± 10%	10	100	2600	3650	250	300
CI-B2012-82N	8.2		10	100	2200	3000	280	300
CI-B2012-100	10		10	100	1800	2500	300	300
CI-B2012-120	12		10	100	1650	2450	350	300
CI-B2012-150	15		10	100	1350	2000	400	300
CI-B2012-180	18		10	100	1350	1750	450	300
CI-B2012-220	22		15	100	1100	1500	500	300
CI-B2012-270	27		15	100	1100	1500	550	300
CI-B2012-330	33		15	100	900	1200	600	300
CI-B2012-390	39		15	100	900	1300	650	300
CI-B2012-470	47		15	100	850	1150	700	300
CI-B2012-560	56		15	100	750	1050	750	300
CI-B2012-680	68		15	100	700	1000	800	300
CI-B2012-820	82		15	100	600	950	900	300
CI-B2012-101	100		15	100	500	850	1000	300
CI-B2012-121	120		15	50	450	730	1300	250
CI-B2012-151	150		15	50	400	570	1500	250
CI-B2012-181	180		15	50	350	510	1800	250
CI-B2012-221	220		10	50	330	450	2000	250
CI-B2012-271	270		10	50	300	410	2500	250
CI-B2012-331	330	10	50	270	370	3000	250	
CI-B2012-391	390	10	50	220	330	3500	250	
CI-B2012-471	470	10	50	180	280	4000	250	

* SRF : Self-Resonant Frequency.

* DCR : DC Resistance

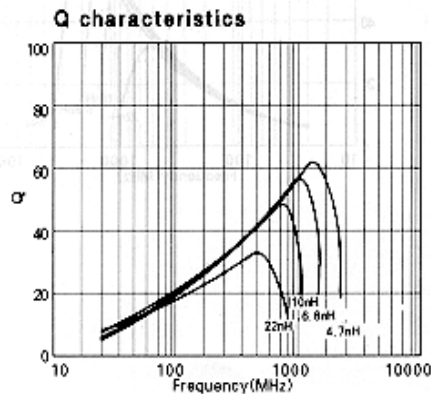
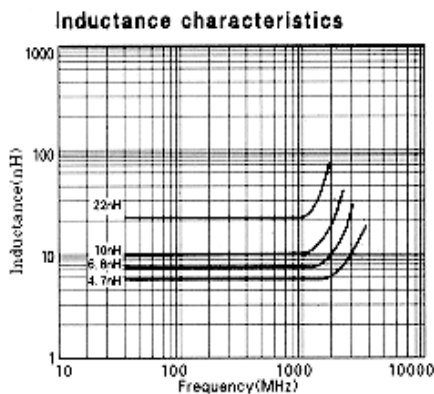
Electrical characteristics

RELIABILITY AND TEST CONDITIONS

CHIP CERAMIC INDUCTORS

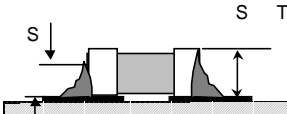
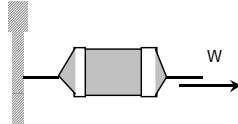
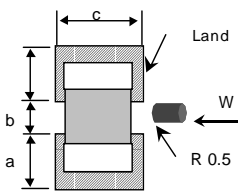
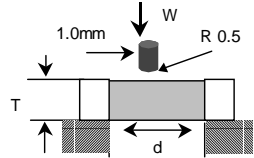
ITEM	REQUIREMENTS			TEST CONDITION
	1005	1608	2012	
Operating temp. range	-55 ~+125			-
Storage temp. & humidity range	40 max. , 70% RH max.			at packing condition
Resistance to solder heat	1.No damage such as cracks should be caused in chip element. 2.More than 75% of the terminal electrode shall be covered with new solder. 3.Inductance change : \pm within 5% 4.Quality factor change : \pm within 30%			Preheat temperature : 100 to 150 Preheat time : 1min Solder temperature : 260 \pm 10 Dipping time : 10 \pm 0.5sec.
Solderability	1.More than 90% of the terminal electrode shall be covered with new solder. 2.Inductance change : \pm within 5% 3.Quality factor change : \pm within 30%			Preheat temperature : 100 to 150 Preheat time : 1min Solder temperature : 230 \pm 10 Dipping time : 3 \pm 1sec.
Reflow soldering	1.More than 50% of the terminal electrode shall be covered with new solder. <div style="text-align: center;">  </div>			Preheat temperature : 150 Preheat time : 1min Solder temperature : 230 Soldering time : 10 sec. Max. (Reflow soldering profile)
Tensile strength (Terminal strength)	1.No mechanical damage <div style="text-align: right;">Unit : Kgf(W)</div>			
	W	-	1.0	2.0
Adhesion of Terminal electrode (Flexure strength)	1.No mechanical damage <div style="text-align: right;">Unit : mm (a,b,c), Kgf(W)</div>			
	a	-	1.0	1.0
	b	-	0.8	1.0
	c	-	1.3	1.3
	W	-	2.0	4.0
Body strength (Bending strength)	1.The body shall not be damaged by forces applied on the right. <div style="text-align: right;">Unit : mm (d), Kgf(W)</div>			
	d	-	1.3	1.3
	W	-	2.0	3.0

	ITEM	PAGE
	CHIP CERAMIC INDUCTORS	6/9

CHIP CERAMIC INDUCTORS

ITEM	REQUIREMENTS			TEST CONDITION
	1005	1608	2012	
Drop	1.No mechanical damae			Drop 10 times on a concrete Floor from a height of 91cm
Vibration	1.No mechanical damae			Frequency : 10-55-10Hz Amplitude : 1.52mm Direction and time : X,Y,Z directions for 2 hours
Thermal shock (Temperature cycle)	1.No mechanical damae 2.Inductance change : \pm within 5% 3.Quality factor change : \pm within 30%			Step1. -40 \pm 3 30 \pm 3min. Step2. 85 \pm 3 30 \pm 3min. Number of cycle : 100 times
Heat load resistance	1.No mechanical damae 2.Inductance change : \pm within 5% 3.Quality factor change : \pm within 30%			Temperature : 85 \pm 2 Applied current : rated current Time : 1,000 hours Measured at room ambient temperature after placing for 24 hours
Low temp. resistance	1.No mechanical damae 2.Inductance change : \pm within 5% 3.Quality factor change : \pm within 30%			Temperature : -40 \pm 5 Time : 1,000 hours Measured at room ambient temperature after placing for 24 hours
Humidity resistance	1.No mechanical damae 2.Inductance change : \pm within 5% 3.Quality factor change : \pm within 30%			Temperature : 40 \pm 2 Humidity : 90-95% RH Time : 500 hours Measured at room ambient temperature after placing for 24 hours
Humidity load resistance	1.No mechanical damae 2.Inductance change : \pm within 5% 3.Quality factor change : \pm within 30%			Temperature : 40 \pm 2 Humidity : 90-95% RH Applied current : rated current Time : 500 hours Measured at room ambient temperature after placing for 24 hours

PACKING

1. Label
 - 1) Part name.
 - 2) Lot No.
 - 3) Quantity.
 - 4) Manufacturer.

2. Standard quantity for packing

Type(EIA)	Packing	Tape & reel			PCS
		Reel	Inner box	Carton box	Vinyl or Cassette
1005		10,000	100,000	400,000	
1608		4,000	40,000	160,000	As wanted
2012		3,000	30,000	120,000	

* Packing method can be changed, based on user's request.

TAPE DIMENSION/ Embossing 8mm

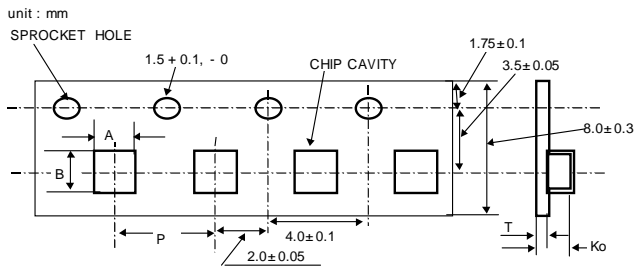

Type	A ± 0.1	B ± 0.1	P ± 0.1	K ₀ ± 0.1	T (max.)
1608	1.00	1.80	4.0	0.95	0.3
2012	1.45	2.25	4.0	1.00	0.3

TAPE DIMENSION/ Paper

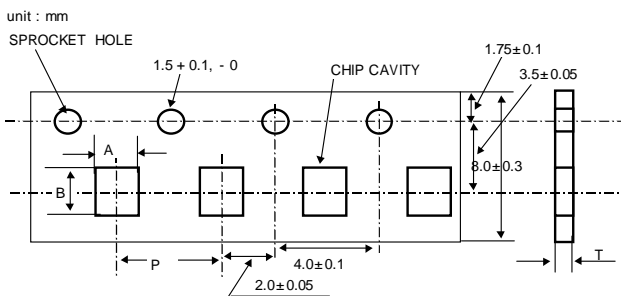

Type	A ± 0.1	B ± 0.1	P ± 0.1	T (max.)
1005	0.65	1.15	2.0	0.8
1608	1.00	1.80	2.0	1.1

LEADER AND BLANK PORTION

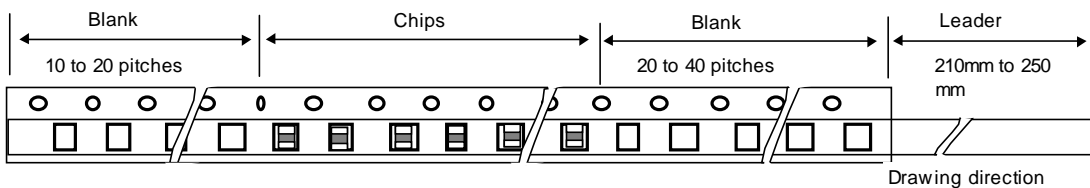

The pitch holes shift within ±0.3mm for cumulative 10 pitches

REEL DIMENSION

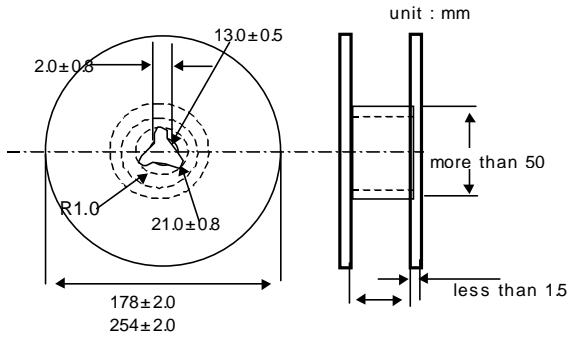

Type	W (mm)
1005, 1608, 2012	9.0 ± 0.3

TOP COVER TAPE STRENGTH

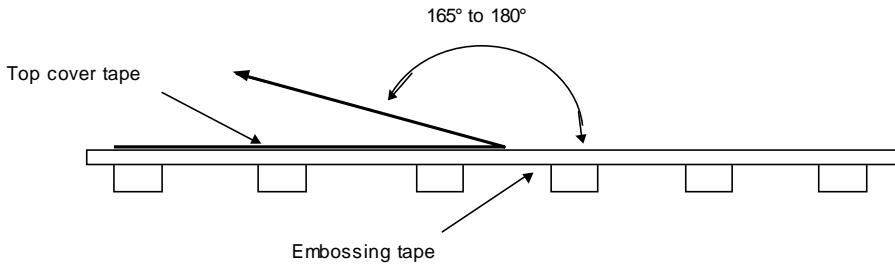

The force for tearing off top cover tape is 20 to 70 grams in the arrow direction

SOLDERING PROFILE

1. REFLOW SOLDERING

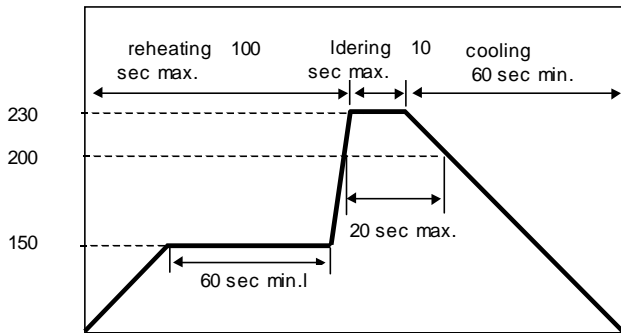

2. FLOW SOLDERING

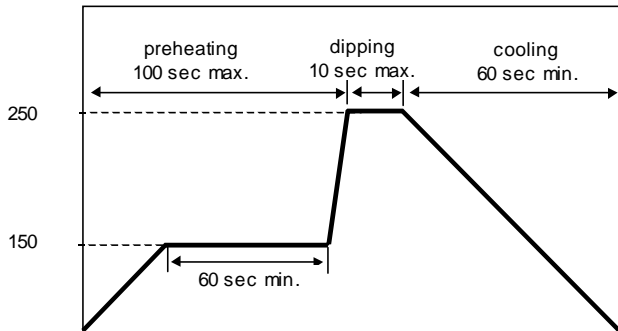

3. MANUAL SOLDERING

