

GaN Enhancement-mode Power Transistor

General description

650V GaN-on-Silicon Enhancement-mode Power Transistor in Dual Flat No-lead Package (DFN) with 5 mm × 6 mm Size

Features

- Enhancement-mode transistor - normally-OFF power switch
- Ultra-high switching frequency
- No reverse-recovery charge
- Low gate charge, low output charge
- Qualified for industrial applications according to JEDEC standards
- ESD safeguard
- RoHS, Pb-free, REACH-compliant

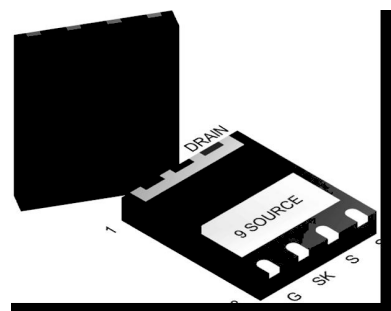

Applications

- AC-DC converters
- DC-DC converters
- Totem pole PFC
- Fast battery charging
- High-density power conversion
- High-efficiency power conversion

Table 1 Key Performance Parameters at $T_j = 25\text{ }^\circ\text{C}$

Parameters	Values	Units
$V_{DS, \max}$	650	V
$R_{DS(on), \max}$	140	m Ω
Q_G, typ	3.3	nC
I_D, Pulse	32	A
$Q_{OSS} @ 400\text{ V}$	33	nC
Q_{rr}	0	nC

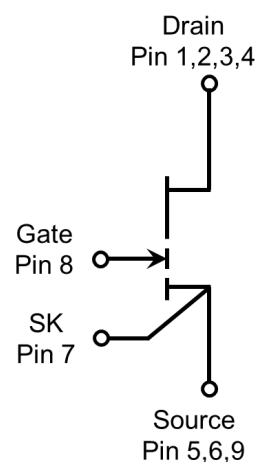

Gate	8
Drain	1, 2, 3, 4
Kelvin Source	7
Source	5, 6, 9

Table 2 Ordering Information

Type/Ordering Code	Package	Marking
CID18N65D5	DFN 5x6, 2500 pcs/reel	18N65

1 Maximum ratings

at $T_j = 25\text{ °C}$ unless otherwise specified. Continuous application of maximum ratings can deteriorate transistor lifetime. For further information, contact Tokmas sales office.

Table 3 Maximum rating

Parameters	Symbols	Values			Units	Notes/Test Conditions
		Min.	Typ.	Max.		
Drain-source voltage	$V_{DS, max}$	-	-	650	V	$V_{GS} = 0\text{ V}$, $I_D = 10\text{ }\mu\text{A}$
Drain-source voltage transient ¹	$V_{DS, transient}$	-	-	750	V	$V_{GS} = 0\text{ V}$, $V_{DS} = 750\text{ V}$
Continuous current, drain-source	I_D	-	-	17	A	$T_c = 25\text{ °C}$
Pulsed current, drain-source ²	$I_{D, pulse}$	-	-	32	A	$T_c = 25\text{ °C}$; $V_G = 6\text{ V}$
Pulsed current, drain-source ²	$I_{D, pulse}$	-	-	18	A	$T_c = 125\text{ °C}$; $V_G = 6\text{ V}$
Gate-source voltage, continuous ³	V_{GS}	-1.4	-	+7	V	$T_j = -55\text{ °C}$ to 150 °C
Gate-source voltage, pulsed	$V_{GS, pulse}$	-	-	+10	V	$T_j = -55\text{ °C}$ to 150 °C ; $t_{Pulse} = 50\text{ ns}$, $f = 100\text{ kHz}$; open drain
Power dissipation	P_{tot}	-	-	113	W	$T_c = 25\text{ °C}$
Operating temperature	T_j	-55	-	+150	°C	
Storage temperature	T_{stg}	-55	-	+150	°C	

1. $V_{DS, transient}$ is intended for surge rating during non-repetitive events, $t_{Pulse} < 1\text{ }\mu\text{s}$.

2. Pulse width = $10\text{ }\mu\text{s}$.

3. The minimum V_{GS} is clamped by ESD protection circuit, as shown in Figure 8.

2 Thermal characteristics

Table 4 Thermal characteristics

Parameters	Symbols	Values			Units	Notes/Test Conditions
		Min.	Typ.	Max.		
Thermal resistance, junction-case	R_{thJC}	-	-	1.1	°C/W	
Reflow soldering temperature	T_{sold}	-	-	260	°C	MSL3

3 Electrical characteristics

at $T_j = 25\text{ °C}$, unless specified otherwise.

Table 5 Static characteristics

Parameters	Symbols	Values			Units	Notes/Test Conditions
		Min.	Typ.	Max.		
Gate threshold voltage	$V_{GS(TH)}$	1.2	1.7	2.5	V	$I_D = 17.2\text{ mA}$; $V_{DS} = V_{GS}$; $T_j = 25\text{ °C}$
		-	1.6	-		$I_D = 17.2\text{ mA}$; $V_{DS} = V_{GS}$; $T_j = 125\text{ °C}$
Drain-source leakage current	I_{DSS}	-	0.6	20	μA	$V_{DS} = 650\text{ V}$; $V_{GS} = 0\text{ V}$; $T_j = 25\text{ °C}$
		-	1	-		$V_{DS} = 650\text{ V}$; $V_{GS} = 0\text{ V}$; $T_j = 125\text{ °C}$
Gate-source leakage current	I_{GSS}	-	40	200	μA	$V_{GS} = 6\text{ V}$; $V_{DS} = 0\text{ V}$
Drain-source on-state resistance	$R_{DS(on)}$	-	100	140	$\text{m}\Omega$	$V_{GS} = 6\text{ V}$; $I_D = 5\text{ A}$; $T_j = 25\text{ °C}$
		-	200	-	$\text{m}\Omega$	$V_{GS} = 6\text{ V}$; $I_D = 5\text{ A}$; $T_j = 125\text{ °C}$
Gate resistance	R_G	-	3.5	-	Ω	$f = 5\text{ MHz}$; open drain

Table 6 Dynamic characteristics

Parameters	Symbols	Values			Units	Notes/Test Conditions
		Min.	Typ.	Max.		
Input capacitance	C_{iss}	-	125	-	pF	$V_{GS} = 0\text{ V}$; $V_{DS} = 400\text{ V}$; $f = 100\text{ kHz}$
Output capacitance	C_{oss}	-	40	-	pF	$V_{GS} = 0\text{ V}$; $V_{DS} = 400\text{ V}$; $f = 100\text{ kHz}$
Reverse transfer capacitance	C_{riss}	-	0.5	-	pF	$V_{GS} = 0\text{ V}$; $V_{DS} = 400\text{ V}$; $f = 100\text{ kHz}$
Effective output capacitance, energy related ¹	$C_{o(er)}$	-	53	-	pF	$V_{GS} = 0\text{ V}$; $V_{DS} = 0\text{ to }400\text{ V}$
Effective output capacitance, time related ²	$C_{o(tr)}$	-	81	-	pF	$V_{GS} = 0\text{ V}$; $V_{DS} = 0\text{ to }400\text{ V}$
Output charge	Q_{oss}	-	33	-	nC	$V_{GS} = 0\text{ V}$; $V_{DS} = 0\text{ to }400\text{ V}$

1. $C_{o(er)}$ is the fixed capacitance that gives the same stored energy as C_{oss} while V_{DS} is rising from 0 to 400 V.

2. $C_{o(tr)}$ is the fixed capacitance that gives the same charging time as C_{oss} while V_{DS} is rising from 0 to 400 V.

Table 7 Gate charge characteristics

Parameters	Symbols	Values			Units	Notes/Test Conditions
		Min.	Typ.	Max.		
Gate charge	Q_G	-	3.3	-	nC	$V_{GS} = 0$ to 6 V; $V_{DS} = 400$ V; $I_D = 5$ A
Gate-source charge	Q_{GS}	-	0.3	-	nC	
Gate-drain charge	Q_{GD}	-	1.25	-	nC	
Gate plateau voltage	V_{plat}	-	2.4	-	V	$V_{DS} = 400$ V; $I_D = 5$ A

Table 8 Reverse conduction characteristics

Parameters	Symbols	Values			Units	Notes/Test Conditions
		Min.	Typ.	Max.		
Source-drain reverse voltage	V_{SD}	-	2.5	-	V	$V_{GS} = 0$ V; $I_{SD} = 5$ A
Pulsed current, reverse	$I_{S, pulse}$	-	28	-	A	$V_{GS} = 6$ V
Reverse recovery charge	Q_{rr}	-	0	-	nC	$I_{SD} = 5$ A; $V_{DS} = 400$ V
Reverse recovery time	t_{rr}	-	0	-	ns	
Peak reverse recovery current	I_{rrm}	-	0	-	A	

4 Electrical characteristics diagrams

at $T_j = 25\text{ }^\circ\text{C}$, unless specified otherwise.

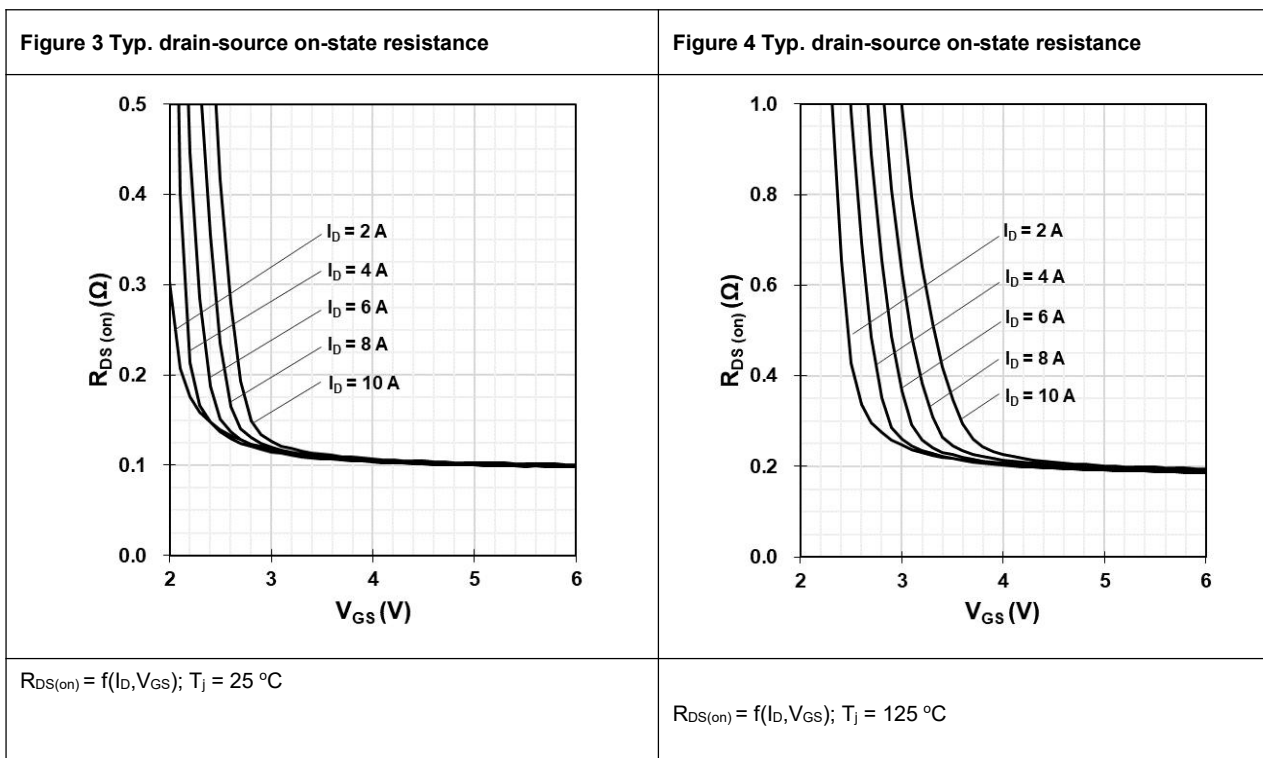
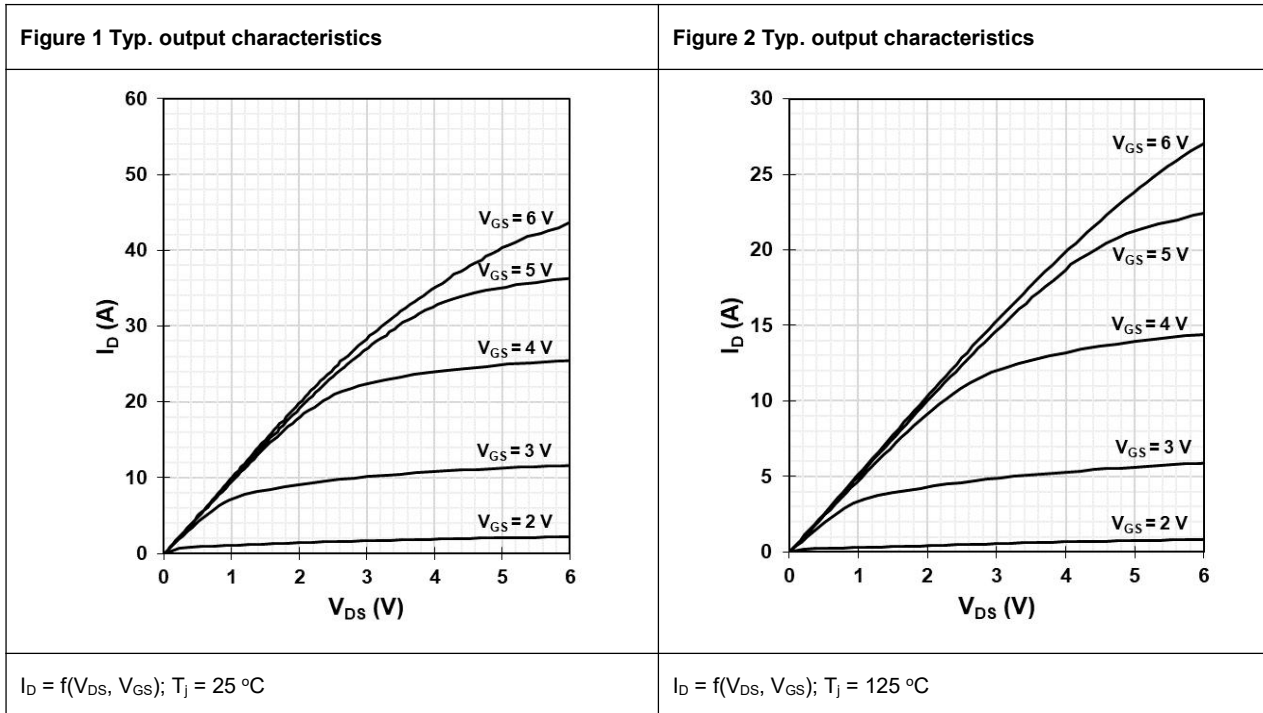

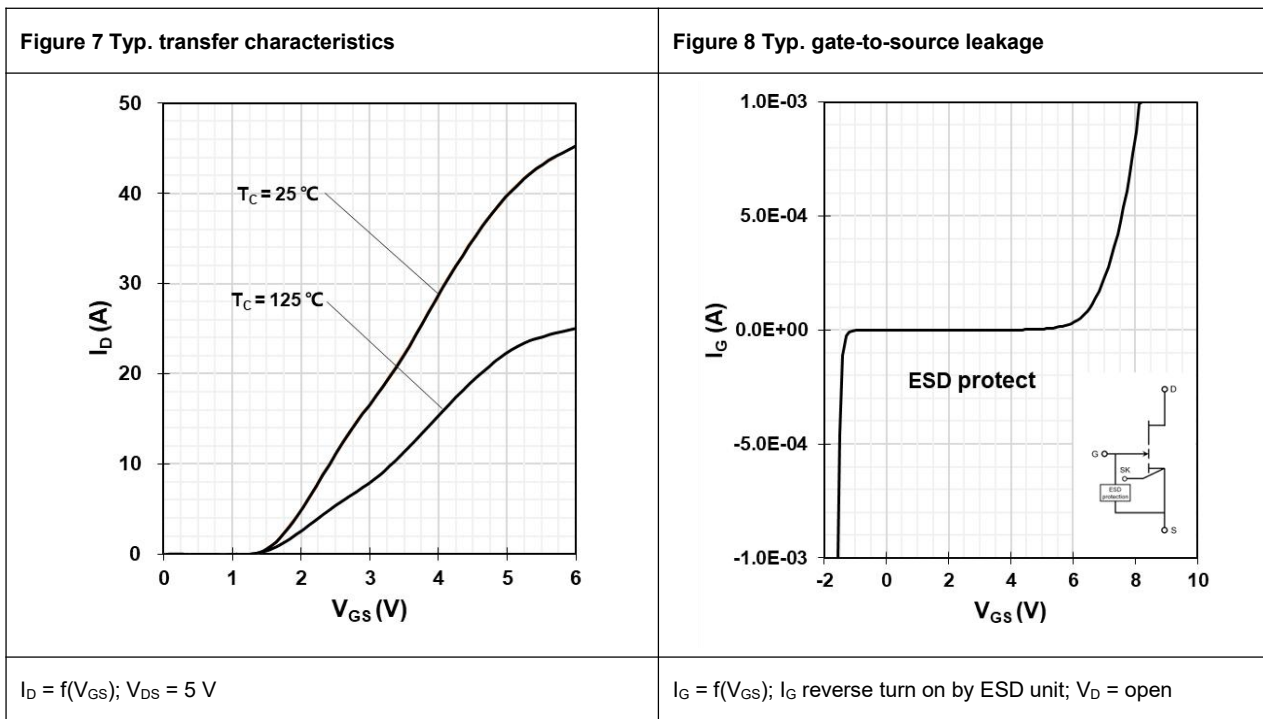
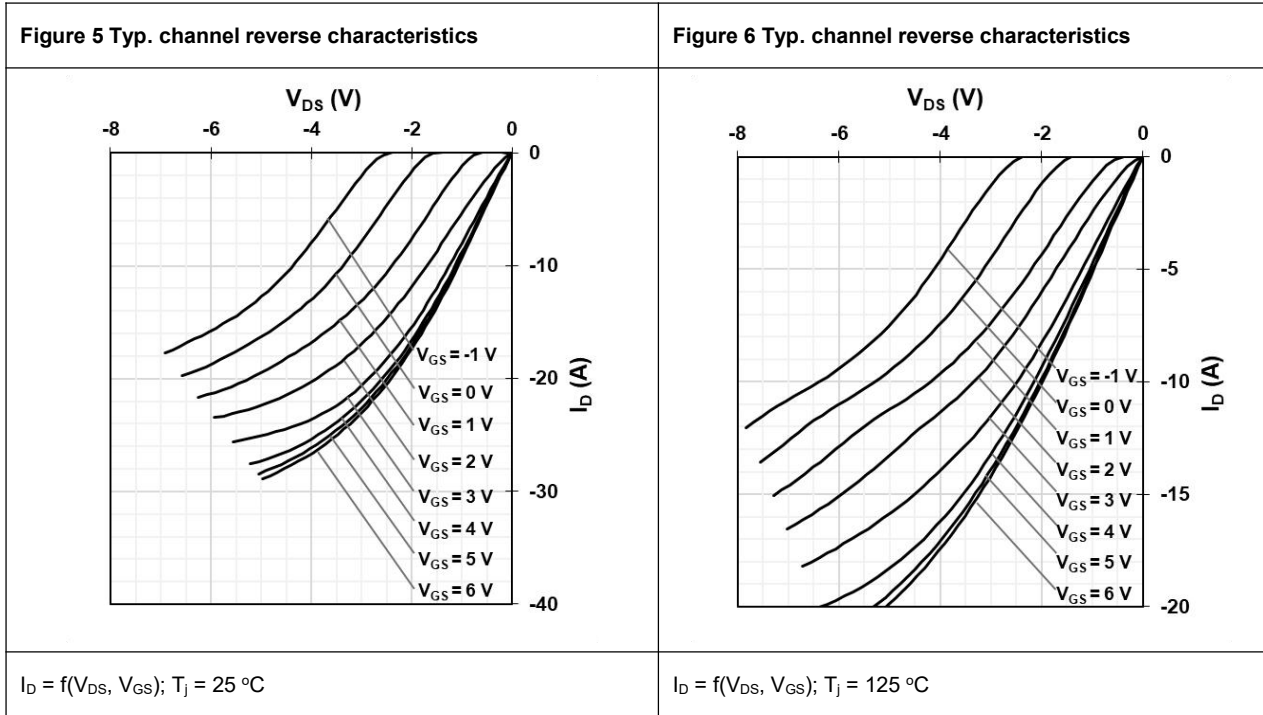

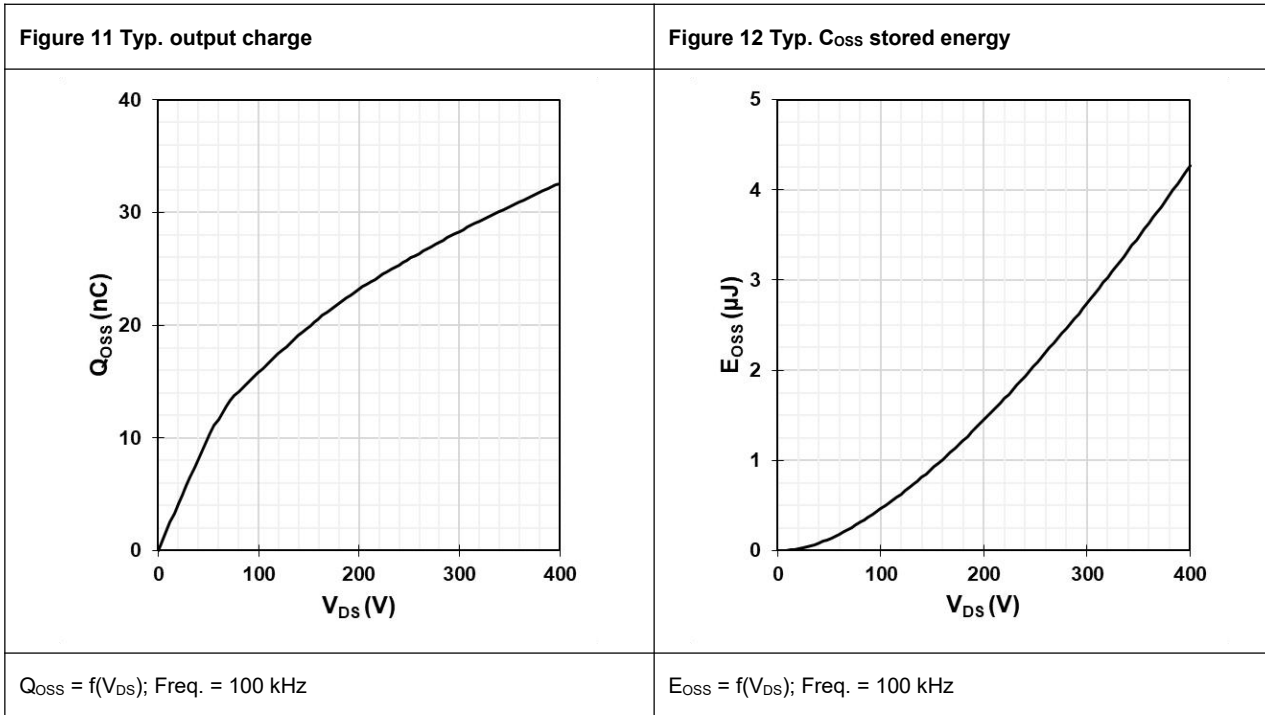
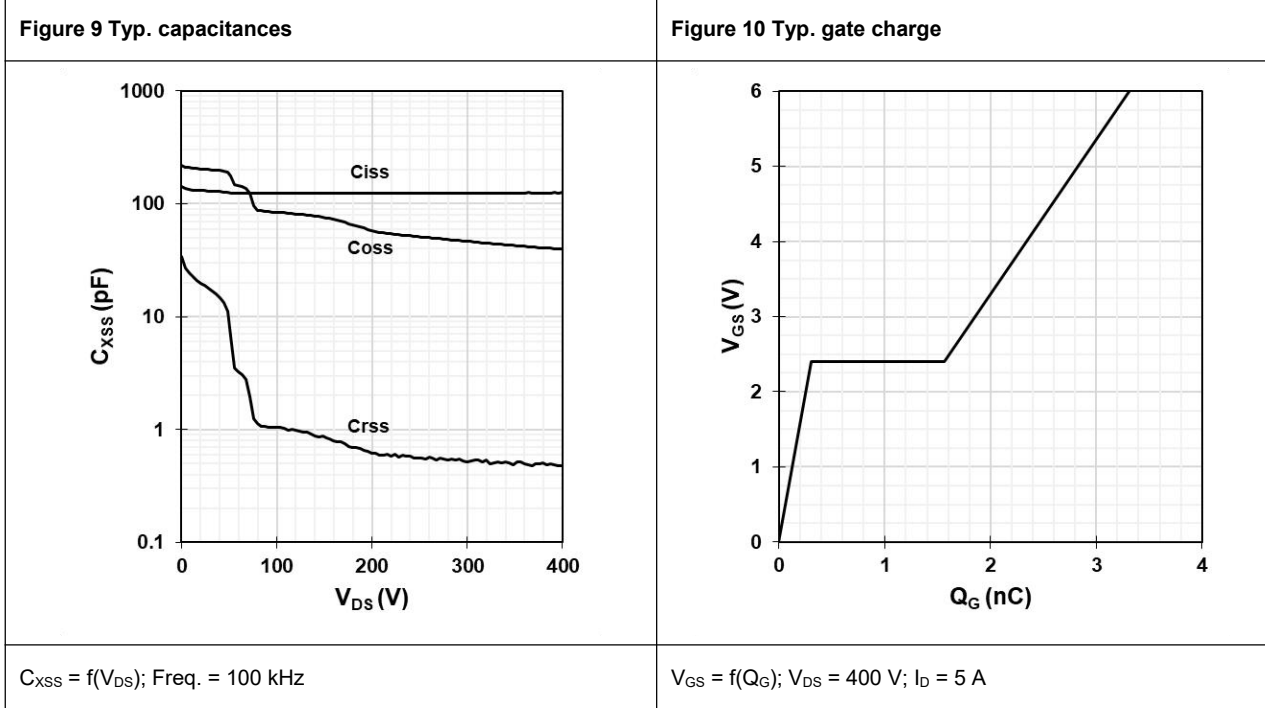

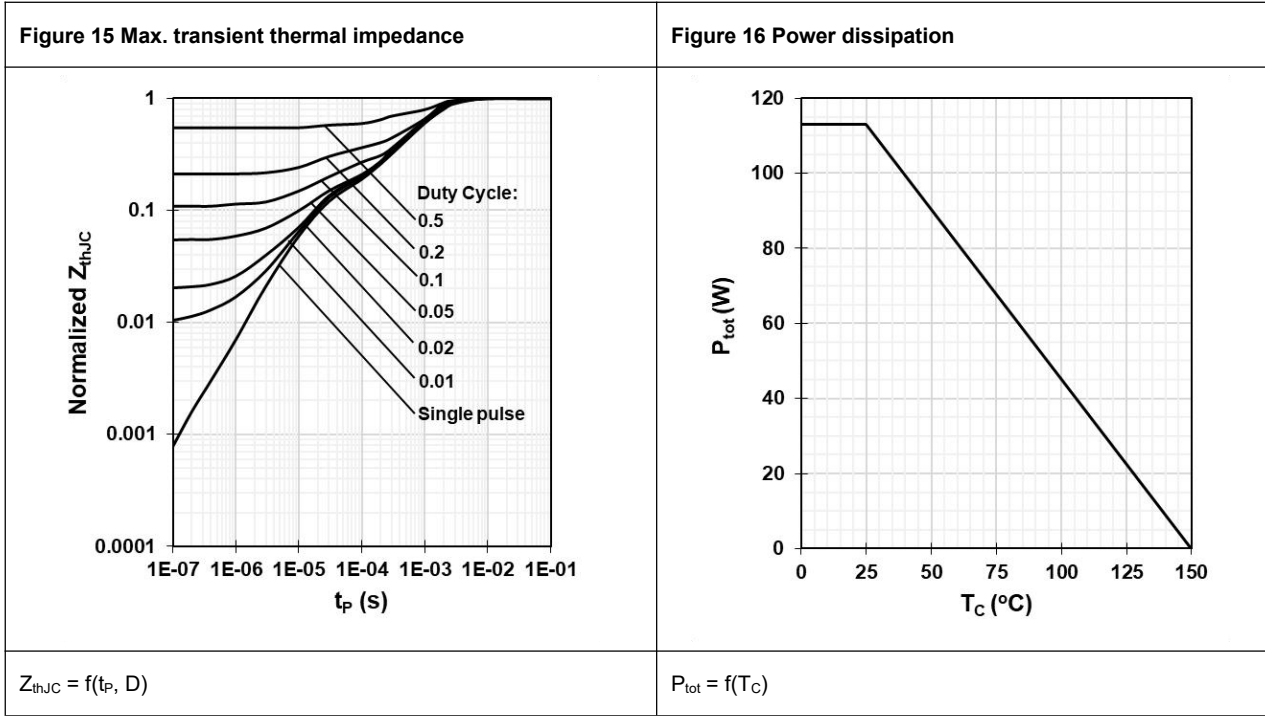
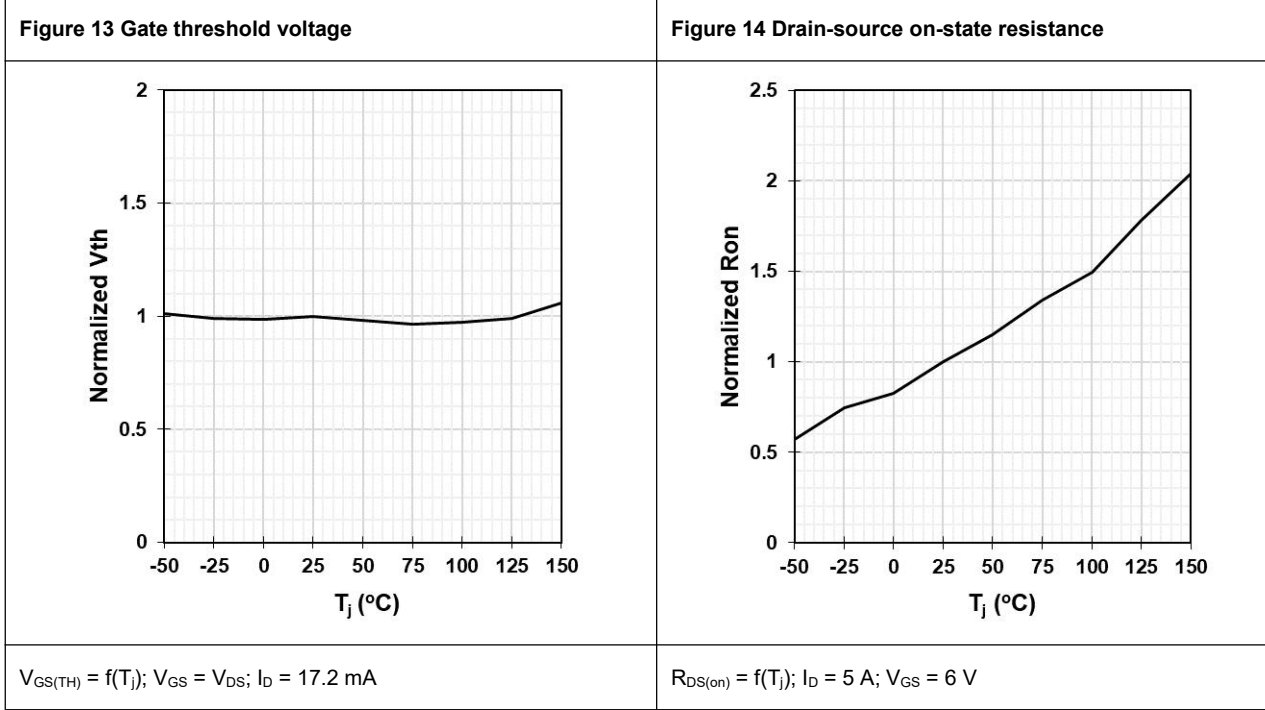
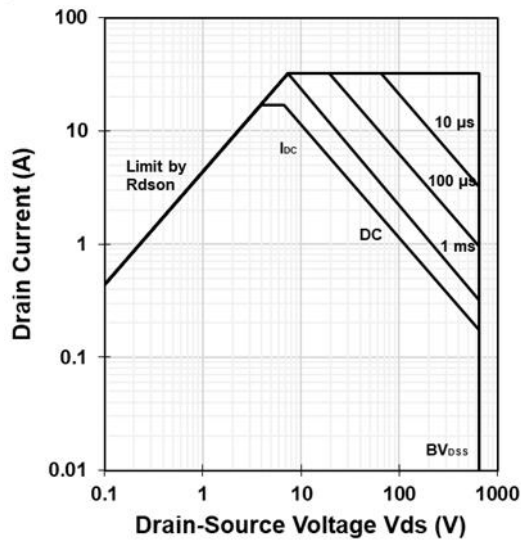
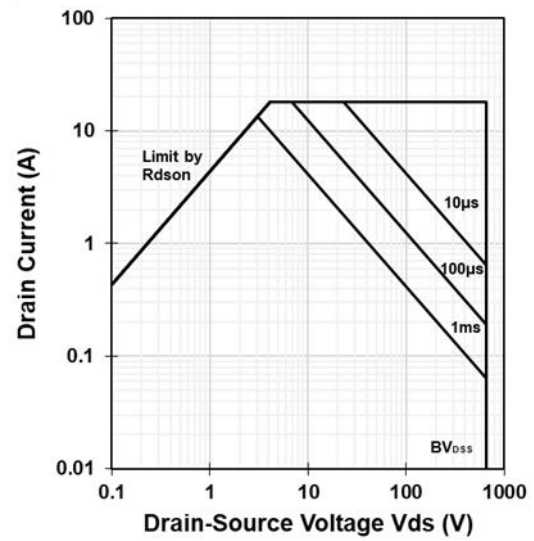

Figure 17 Safe operating area



$$I_D = f(V_{DS}); T_C = 25\text{ }^\circ\text{C}$$

Figure 18 Safe operating area



$$I_D = f(V_{DS}); T_C = 125\text{ }^\circ\text{C}$$

Figure 19 Switching times test circuit

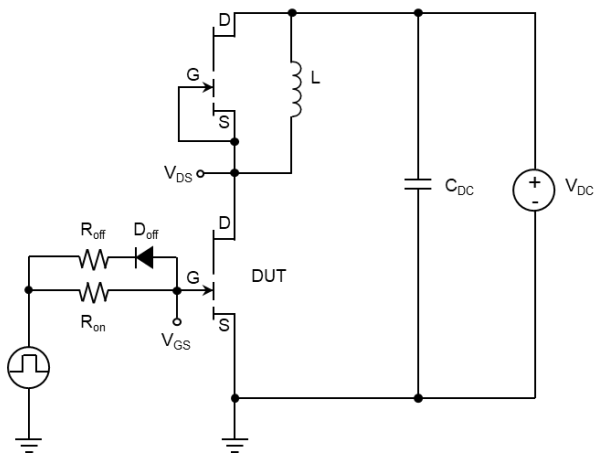

$$V_{DS} = 400\text{ V}, I_D = 10\text{ A}, L = 318\text{ }\mu\text{H}, V_{GS} = 6\text{ V},$$

$$R_{on} = 10\text{ }\Omega, R_{off} = 2\text{ }\Omega$$

Figure 20 Typ. switching times waveform

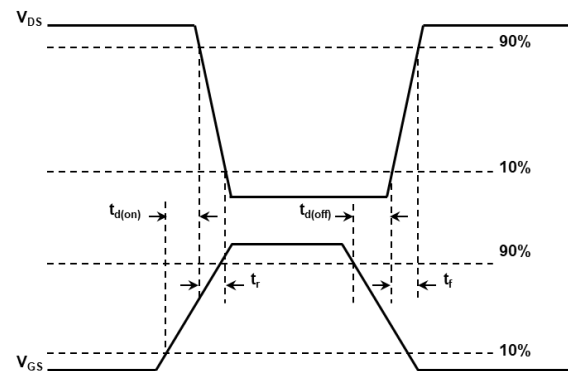

5 Package outlines

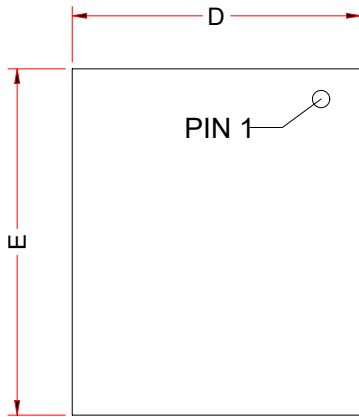

TOP VIEW

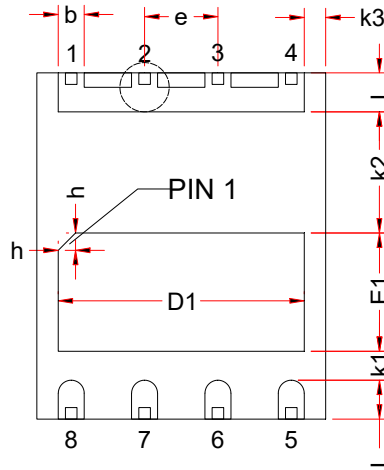

BOTTOM VIEW

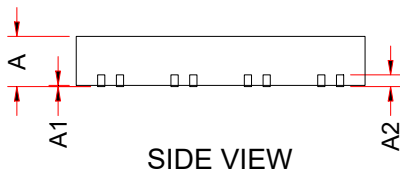

SIDE VIEW

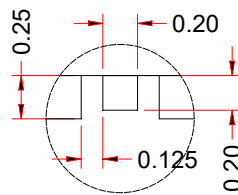

LEAD DETAIL

	MIN	MID	MAX
A	0.75	0.85	0.95
A1	0.00	0.02	0.05
A2	0.203REF		
b	0.40	0.45	0.50
D	4.90	5.00	5.10
D1	4.16	4.26	4.36
E	5.90	6.00	6.10
E1	1.95	2.05	2.15
h	0.20	0.30	0.40
L	0.575	0.675	0.775
e	1.270BSC		
k1	0.400MIN		
k2	2.000MIN		
k3	0.270MIN		

6 Reel information

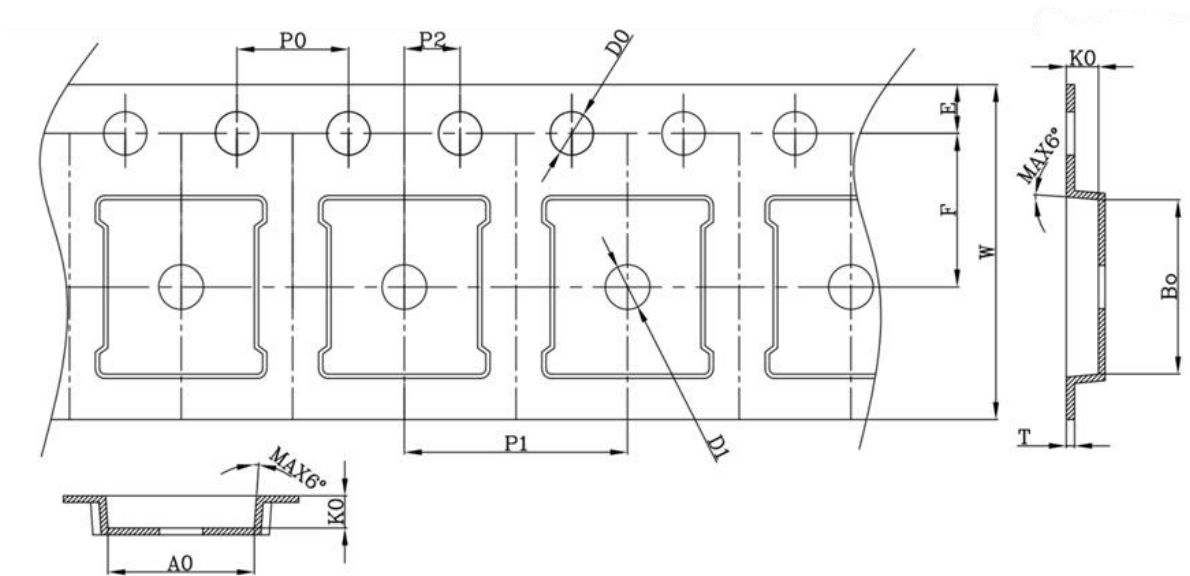

SYMBOL	DIMENSION	SYMBOL	DIMENSION
W	12.00±0.30	10P0	40.00±0.20
E	1.75±0.10	P1	8.00±0.10
F	5.50±0.05	A0	5.25±0.10
D0	1.55±0.05	B0	6.25±0.10
D1	1.55±0.10	K0	1.15±0.10
P0	4.00±0.10	T	0.25±0.05
P2	2.00±0.05		

