

N-Channel Enhancement Mode MOSFET

Feature

- 30V/5.8A, $R_{DS(ON)} = 35m\Omega(MAX)$ @ $V_{GS} = 10V$.
 $R_{DS(ON)} = 40m\Omega(MAX)$ @ $V_{GS} = 4.5V$.
 $R_{DS(ON)} = 55m\Omega(MAX)$ @ $V_{GS} = 2.5V$.
- Super High dense cell design for extremely low $R_{DS(ON)}$.
- Reliable and Rugged.
- SC-59 for Surface Mount Package.

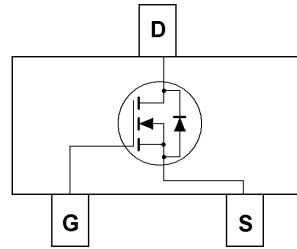

Applications

- Power Management
 Portable Equipment and Battery Powered Systems.

Absolute Maximum Ratings $T_A=25^{\circ}C$ Unless Otherwise noted

Parameter	Symbol	Limit	Units
Drain-Source Voltage	V_{DS}	30	V
Gate-Source Voltage	V_{GS}	± 12	V
Drain Current-Continuous	I_D	5.8	A

Electrical Characteristics $T_A=25^{\circ}C$ Unless Otherwise noted

Parameter	Symbol	Test Conditions	Min	Typ.	Max	Units
Off Characteristics						
Drain to Source Breakdown Voltage	BVDSS	$V_{GS}=0V, I_D=250\mu A$	30	-	-	V
Zero-Gate Voltage Drain Current	I_{DSS}	$V_{DS}=30V, V_{GS}=0V$	-	-	1	μA
Gate Body Leakage Current, Forward	I_{GSSF}	$V_{GS}=12V, V_{DS}=0V$	-	-	100	nA
Gate Body Leakage Current, Reverse	I_{GSSR}	$V_{GS}=-12V, V_{DS}=0V$	-	-	-100	nA
On Characteristics						
Gate Threshold Voltage	$V_{GS(th)}$	$V_{GS} = V_{DS}, I_D=250\mu A$	0.6	-	1.5	V
Static Drain-source On-Resistance	$R_{DS(ON)}$	$V_{GS} = 10V, I_D = 5.8A$	-	30	35	$m\Omega$
		$V_{GS} = 4.5V, I_D = 5A$	-	33	40	$m\Omega$
		$V_{GS} = 2.5V, I_D = 4A$	-	45	55	$m\Omega$
Drain-Source Diode Characteristics and Maximum Ratings						
Drain-Source Diode Forward Voltage	VSD	$V_{GS} = 0V, I_S = 1.25A$			1.2	V

Dynamic							
Q_g	Total Gate Charge	$V_{DS}=15V, V_{GS}=10V, I_D=2A$		8.5	12	nC	
Q_{gs}	Gate-Source Charge			1.1			
Q_{gd}	Gate-Drain Charge			1.8			
t_{on}	Turn-on Time	$V_{DD}=15V, I_D=2A, V_{GS}=10V, R_G=6\Omega$			40	ns	
$t_{d(on)}$	Turn-on Delay time			11			
t_r	Turn-on Rise Time			17			
$T_{d(off)}$	Turn-off Delay Time			37			
t_f	Turn-off Fall Time			20			
t_{off}	Turn-off Time				60		

Typical Characteristics

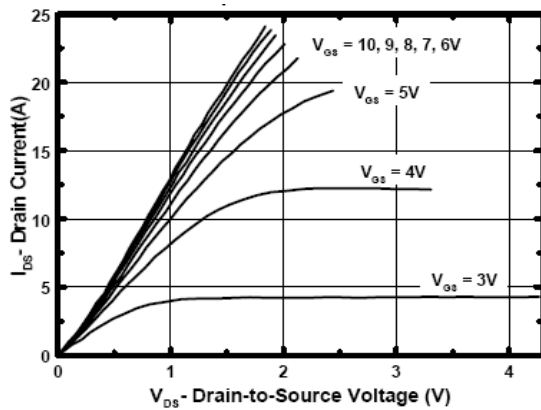

Figure 1. Output Characteristics

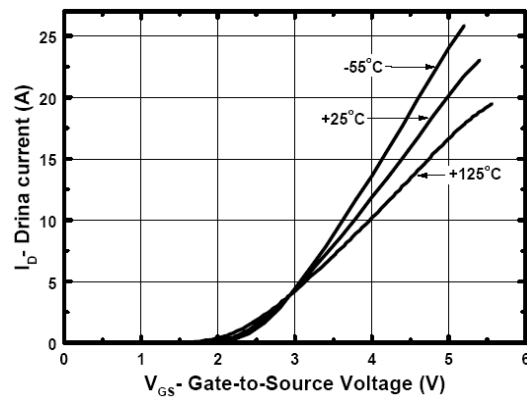

Figure 2. Transfer Characteristics

Typical Characteristics

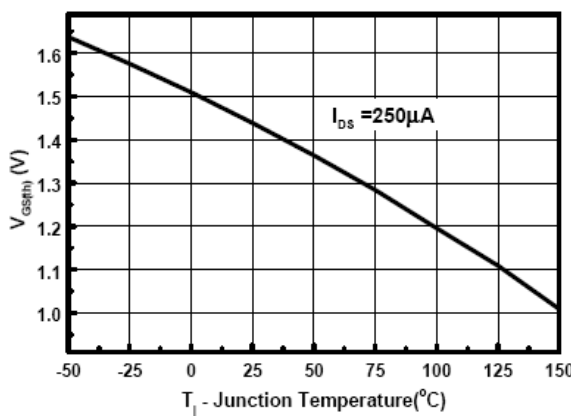

Figure 3. Gate Threshold Variation with Temperature

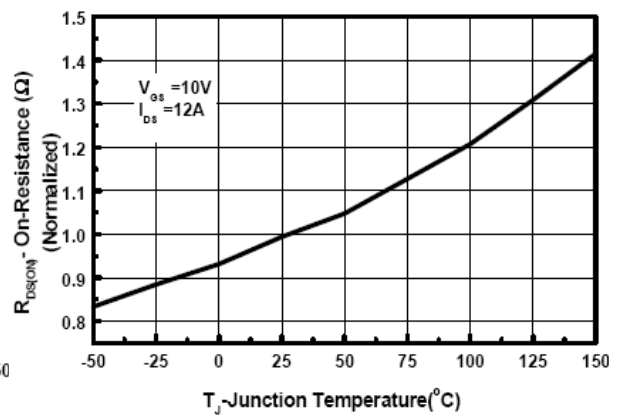

Figure 4. On-Resistance Variation with Temperature

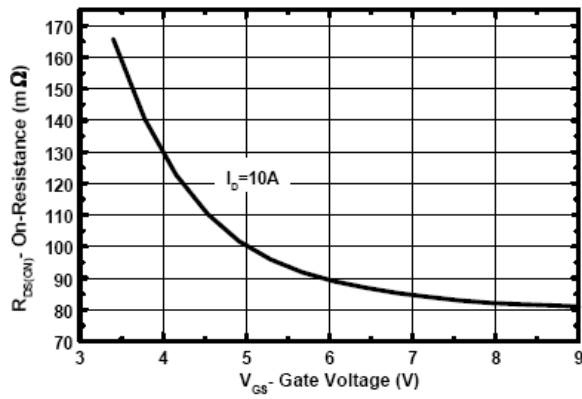

Figure 5. On-Resistance vs. Gate-to-Source Voltage

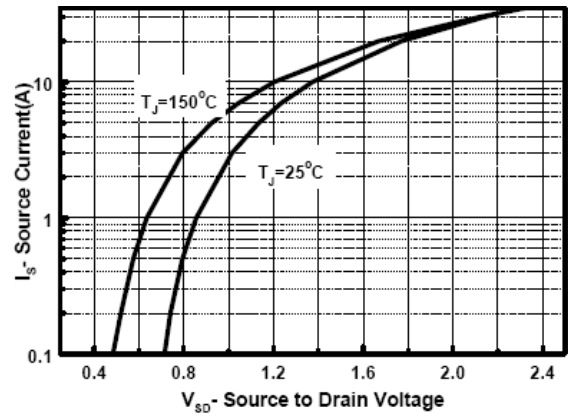
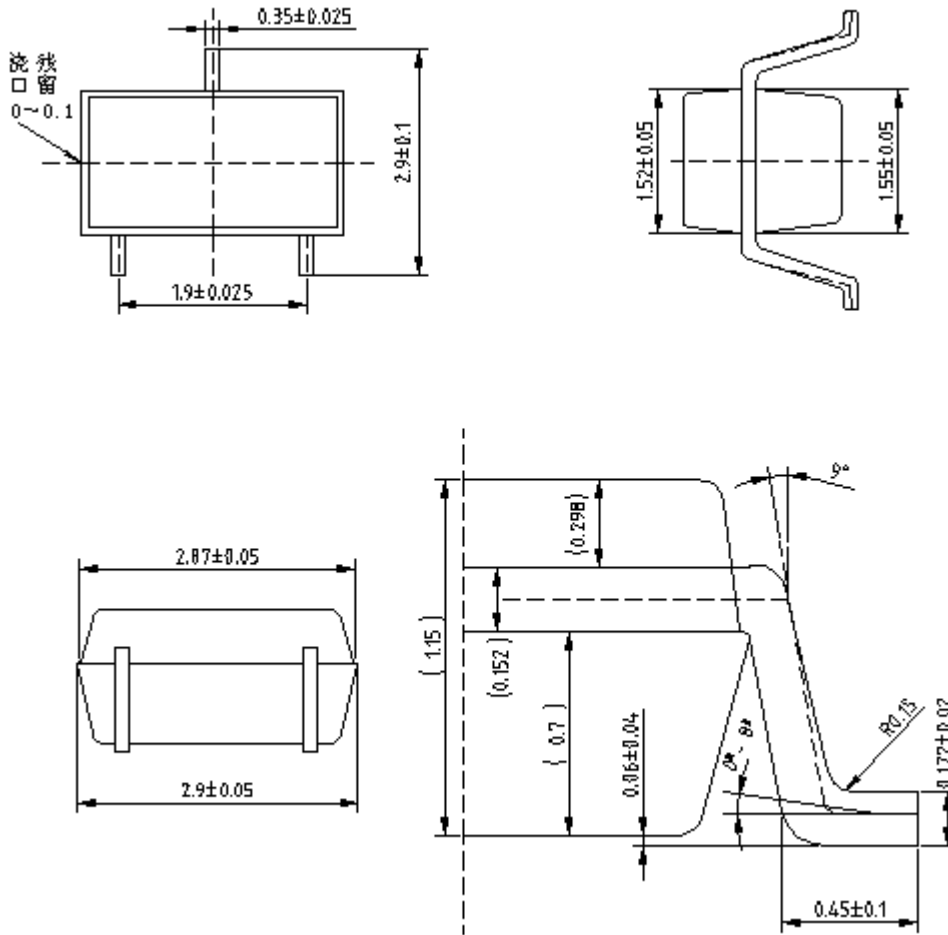

Figure 6. Source-Drain Diode Forward Voltage

Package Outline Dimensions (UNIT: mm)

SC-59



SC-59 Carrier Tape

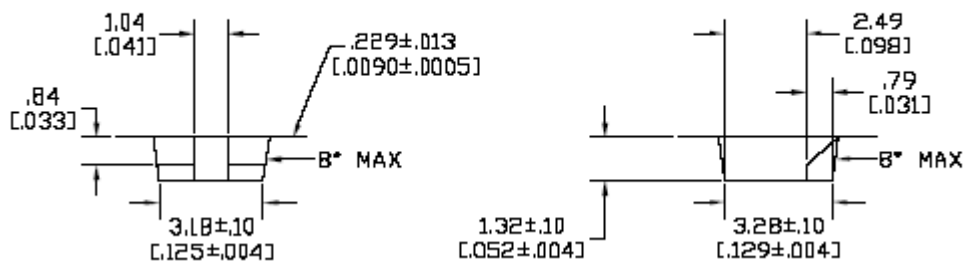

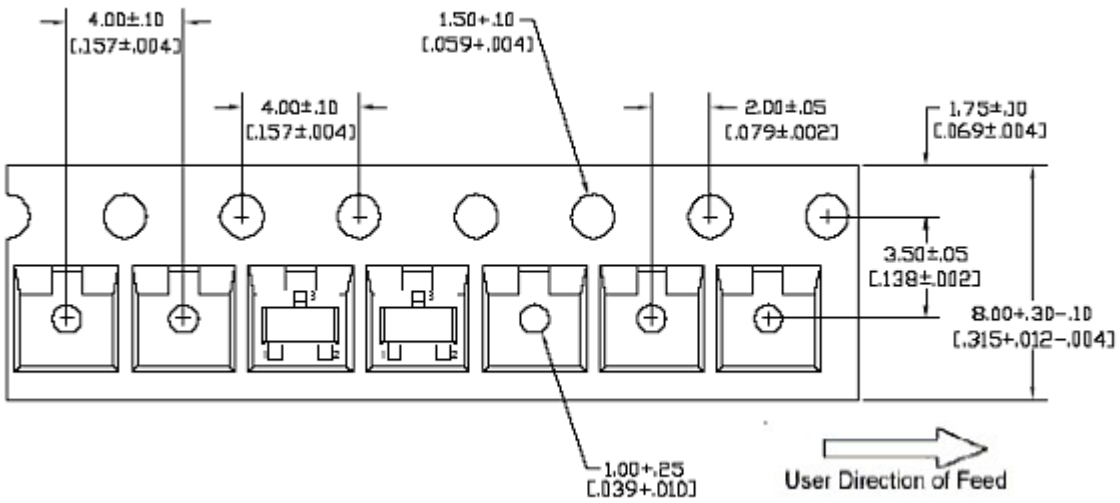

SC-59 Carrier Reel

