

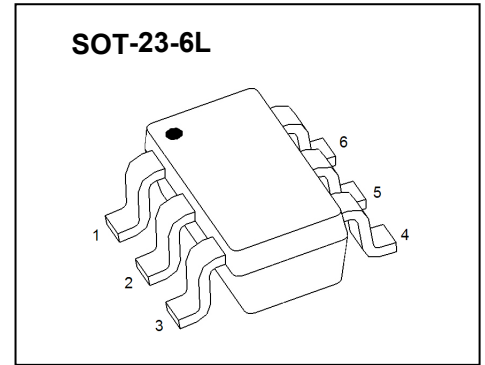

**SOT-23-6L Plastic-Encapsulate MOSFETS**

**CJL8205 Dual N-Channel MOSFET**

$V_{(BR)DSS}$	$R_{DS(on)MAX}$	$I_D$
19V	25mΩ@4.5V	6A
	32mΩ@2.5V	



**FEATURE**

- TrenchFET Power MOSFET
- Excellent  $R_{DS(on)}$
- Low Gate Charge
- High Power and Current Handling Capability
- Surface Mount Package

**APPLICATION**

- Battery Protection
- Load Switch
- Power Management

**MARKING**

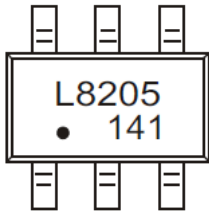

**Equivalent Circuit**

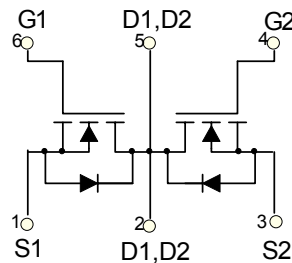

**ABSOLUTE MAXIMUM RATINGS ( $T_a=25^{\circ}C$  unless otherwise noted)**

Parameter	Symbol	Value	Unit
Drain-Source Voltage	$V_{DS}$	19	V
Gate-Source Voltage	$V_{GS}$	±10	V
Continuous Drain Current	$I_D$	6	A
Pulsed Drain Current (note 1)	$I_{DM}$	25	A
Thermal Resistance from Junction to Ambient (note 2)	$R_{\theta JA}$	357	$^{\circ}C/W$
Junction Temperature	$T_J$	150	$^{\circ}C$
Storage Temperature	$T_{STG}$	-55~+150	$^{\circ}C$
Lead Temperature for Soldering Purposes(1/8" from case for 10 s)	$T_L$	260	$^{\circ}C$

## MOSFET ELECTRICAL CHARACTERISTICS

$T_a=25^\circ\text{C}$  unless otherwise specified

Parameter	Symbol	Test Condition	Min	Typ	Max	Unit
<b>STATIC CHARACTERISTICS</b>						
Drain-source breakdown voltage	$V_{(BR)DSS}$	$V_{GS} = 0V, I_D = 250\mu A$	19			V
Zero gate voltage drain current	$I_{DSS}$	$V_{DS} = 18V, V_{GS} = 0V$			1	$\mu A$
Gate-body leakage current	$I_{GSS}$	$V_{GS} = \pm 10V, V_{DS} = 0V$			$\pm 100$	nA
Gate threshold voltage (note 3)	$V_{GS(th)}$	$V_{DS} = V_{GS}, I_D = 250\mu A$	0.5		0.9	V
Drain-source on-resistance (note 3)	$R_{DS(on)}$	$V_{GS} = 4.5V, I_D = 6A$			25	m $\Omega$
		$V_{GS} = 2.5V, I_D = 5A$			32	m $\Omega$
Forward transconductance (note 3)	$g_{FS}$	$V_{DS} = 5V, I_D = 4.5A$		10		S
Diode forward voltage (note 3)	$V_{SD}$	$I_S = 1.25A, V_{GS} = 0V$			1.2	V
<b>DYNAMIC CHARACTERISTICS (note 4)</b>						
Input Capacitance	$C_{iss}$	$V_{DS} = 8V, V_{GS} = 0V, f = 1MHz$		800		pF
Output Capacitance	$C_{oss}$			155		pF
Reverse Transfer Capacitance	$C_{rss}$			125		pF
<b>SWITCHING CHARACTERISTICS (note 4)</b>						
Turn-on delay time	$t_{d(on)}$	$V_{DD} = 10V, V_{GS} = 4V,$ $I_D = 1A, R_{GEN} = 10\Omega$		18		ns
Turn-on rise time	$t_r$			5		ns
Turn-off delay time	$t_{d(off)}$			43		ns
Turn-off fall time	$t_f$			20		ns
Total Gate Charge	$Q_g$	$V_{DS} = 10V, V_{GS} = 4.5V, I_D = 4A$		11		nC
Gate-Source Charge	$Q_{gs}$			2.3		nC
Gate-Drain Charge	$Q_{gd}$			2.5		nC

### Notes :

1. Repetitive rating: Pulse width limited by maximum junction temperature
2. Surface Mounted on FR4 board,  $t \leq 10$  sec.
3. Pulse test : Pulse width  $\leq 300\mu s$ , duty cycle  $\leq 2\%$ .
4. Guaranteed by design, not subject to production.

# Typical Characteristics

Output Characteristics

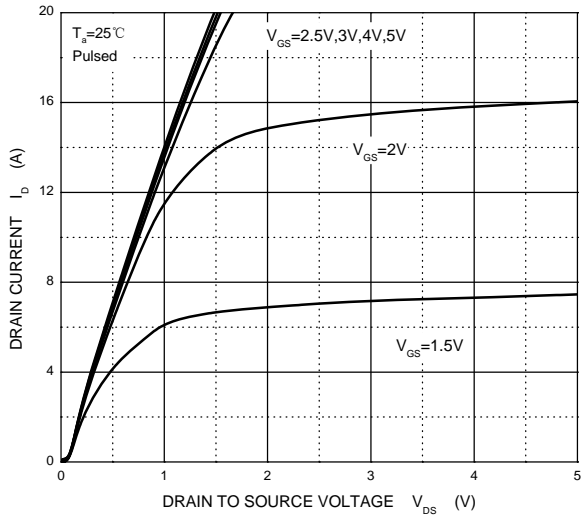

Transfer Characteristics

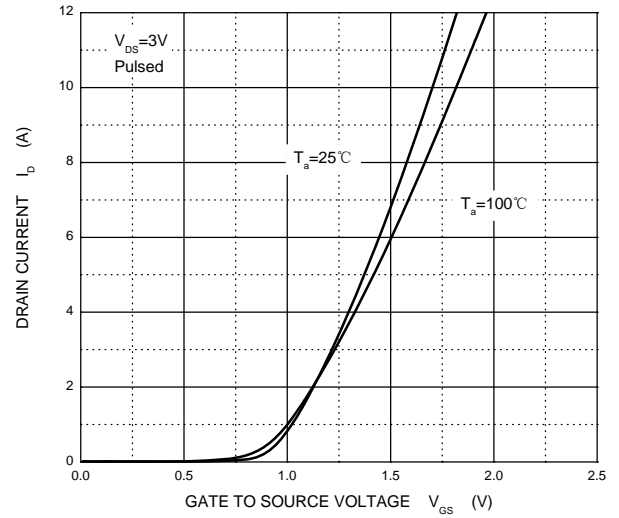

$R_{DS(ON)}$  —  $I_D$

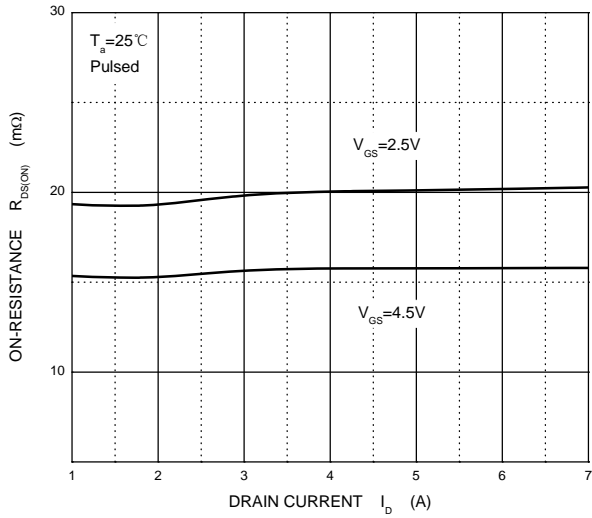

$R_{DS(ON)}$  —  $V_{GS}$

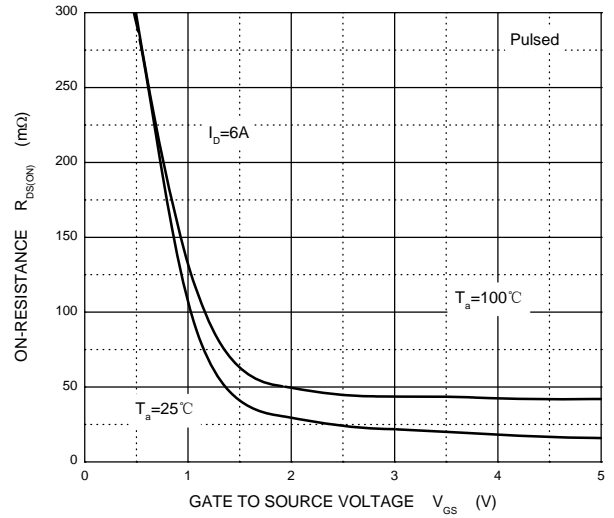

$I_S$  —  $V_{SD}$

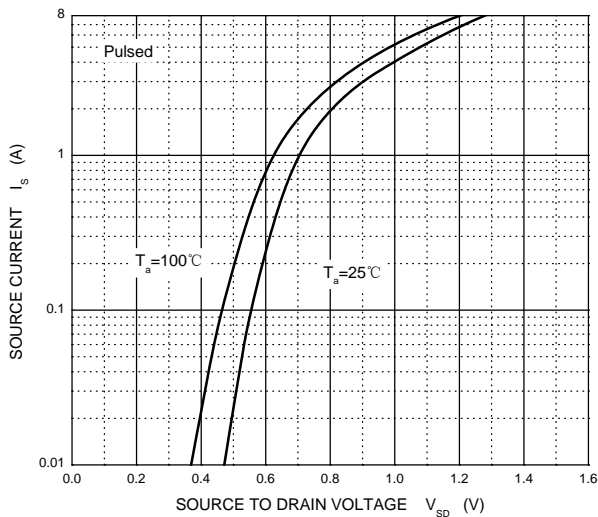

Threshold Voltage

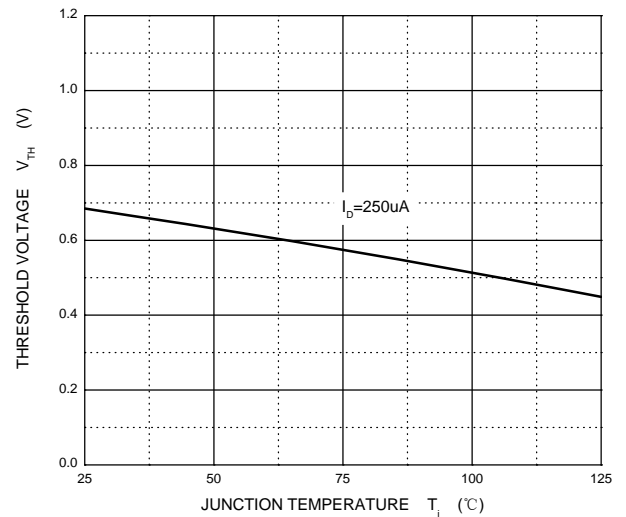

## SOT-23-6L Package Outline Dimensions

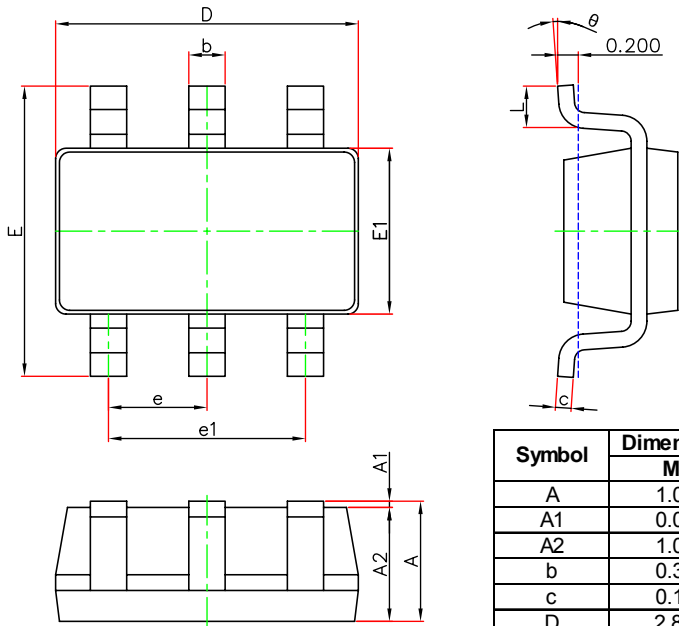

Symbol	Dimensions In Millimeters		Dimensions In Inches	
	Min.	Max.	Min.	Max.
A	1.050	1.250	0.041	0.049
A1	0.000	0.100	0.000	0.004
A2	1.050	1.150	0.041	0.045
b	0.300	0.500	0.012	0.020
c	0.100	0.200	0.004	0.008
D	2.820	3.020	0.111	0.119
E1	1.500	1.700	0.059	0.067
E	2.650	2.950	0.104	0.116
e	0.950(BSC)		0.037(BSC)	
e1	1.800	2.000	0.071	0.079
L	0.300	0.600	0.012	0.024
θ	0°	8°	0°	8°

## SOT-23-6L Suggested Pad Layout

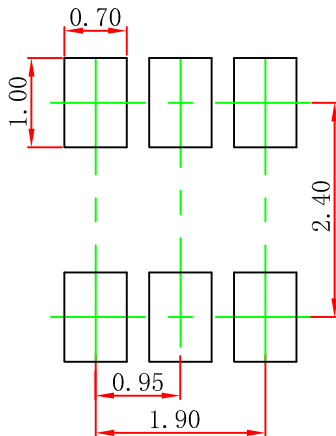

- Note:
1. Controlling dimension: in millimeters.
  2. General tolerance:  $\pm 0.05$  mm.
  3. The pad layout is for reference purposes only.

### NOTICE

JCET reserve the right to make modifications, enhancements, improvements, corrections or other changes without further notice to any product herein. JCET does not assume any liability arising out of the application or use of any product described herein.

# SOT-23-6L Tape and Reel

## SOT-23-6L Embossed Carrier Tape

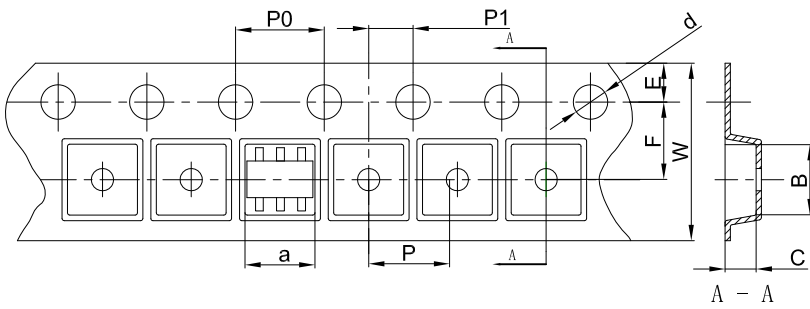

### Packaging Description:

SOT-23-6L parts are shipped in tape. The carrier tape is made from a dissipative (carbon filled) polycarbonate resin. The cover tape is a multilayer film (Heat Activated Adhesive in nature) primarily composed of polyester film, adhesive layer, sealant, and anti-static sprayed agent. These reeled parts in standard option are shipped with 3,000 units per 7" or 18.0cm diameter reel. The reels are clear in color and is made of polystyrene plastic (anti-static coated).

Dimensions are in millimeter										
Pkg type	a	B	C	d	E	F	P0	P	P1	W
SOT-23-6L	3.17	3.23	1.37	Ø1.55	1.75	3.50	4.00	4.00	2.00	8.00

## SOT-23-6L Tape Leader and Trailer

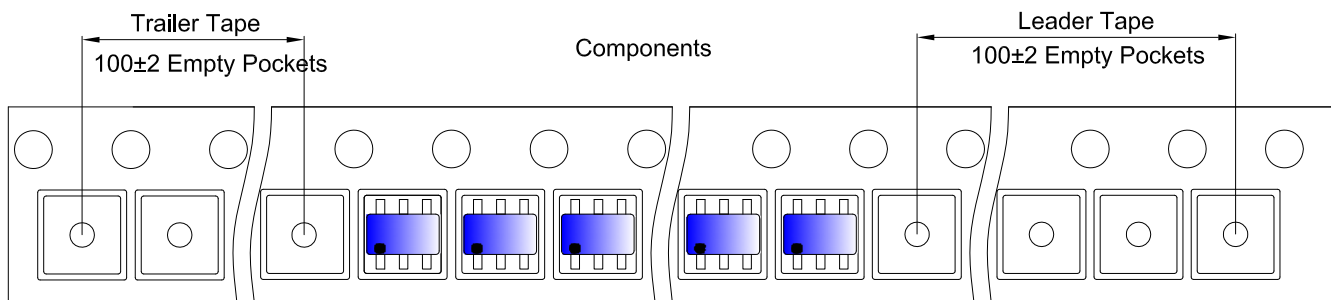

## SOT-23-6L Reel

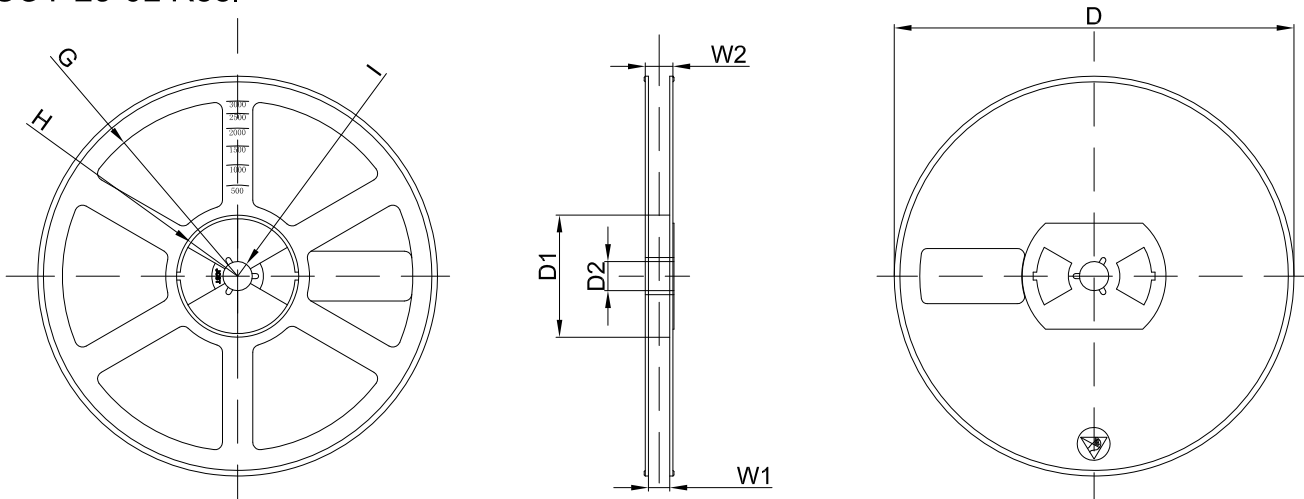

Dimensions are in millimeter								
Reel Option	D	D1	D2	G	H	I	W1	W2
7" Dia	Ø180.00	60.00	13.00	R78.00	R25.60	R6.50	9.50	13.10

REEL	Reel Size	Box	Box Size(mm)	Carton	Carton Size(mm)	G.W.(kg)
3000 pcs	7 inch	30,000 pcs	203×203×195	120,000 pcs	438×438×220	