

TO-220-3L Plastic-Encapsulate MOSFETS

CJP04N60A N-Channel Power MOSFET

$V_{(BR)DSS}$	$R_{DS(on)MAX}$	I_D
600V	3Ω@10V	4A

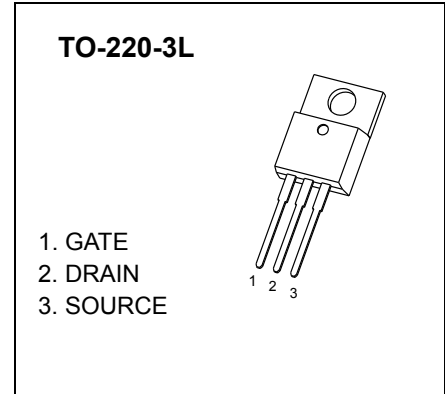

GENERAL DESCRIPTION

This advanced high voltage MOSFET is designed to stand high energy in the avalanche mode and switch efficiently. This new high energy device also offers a drain-to-source diode fast recovery time. Designed for high voltage, high speed switching applications such as power supplies, converters, power motor controls and bridge circuits.

FEATURE

- High Current Rating
- Lower $R_{DS(on)}$
- Lower Capacitance
- Lower Total Gate Charge
- Tighter V_{SD} Specifications
- Avalanche Energy Specified

MARKING



CJP04N60A= Device code
Solid dot = Green molding compound device,
if none, the normal device
XXX=Date Code

EQUIVALENT CIRCUIT

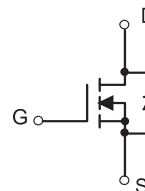

Maximum ratings ($T_a=25^\circ\text{C}$ unless otherwise noted)

Parameter Symbol		Value	Unit
Drain-Source Voltage	V_{DS}	600	V
Gate-Source Voltage	V_{GS}	±30	
Continuous Drain Current	I_D	4.0	A
Pulsed Drain Current	I_{DM}	16	
Single Pulsed Avalanche Energy (note1)	E_{AS}	260	mJ
Thermal Resistance from Junction to Ambient	$R_{\theta JA}$	62.5	$^\circ\text{C}/\text{W}$
Operating and Storage Temperature Range	T_J, T_{STG}	-55 ~+150	$^\circ\text{C}$
Maximum lead temperature for soldering purposes , 1/8"from case for 5 seconds	T_L	260	

MOSFET ELECTRICAL CHARACTERISTICS

$T_a=25^\circ\text{C}$ unless otherwise specified

Parameter	Symbol	Test Condition	Min	Typ	Max	Unit
Off characteristics						
Drain-source breakdown voltage	$V_{(BR)DSS}$	$V_{GS} = 0V, I_D = 250\mu A$	600			V
Drain-source diode forward voltage(note2)	V_{SD}	$V_{GS} = 0V, I_S = 4.0A$			1.5	
Zero gate voltage drain current	I_{DSS}	$V_{DS} = 600V, V_{GS} = 0V$			25	μA
Gate-body leakage current (note2)	I_{GSS}	$V_{DS} = 0V, V_{GS} = \pm 30V$			± 100	nA
On characteristics (note2)						
Gate-threshold voltage	$V_{GS(th)}$	$V_{DS} = V_{GS}, I_D = 250\mu A$	2.0	3.0	4.0	V
Static drain-source on-resistance	$R_{DS(on)}$	$V_{GS} = 10V, I_D = 2.0A$		2.2	3.0	Ω
Forward transconductance	g_{fs}	$V_{DS} = 50V, I_D = 2A$	2.5			S
Dynamic characteristics (note 3)						
Input capacitance	C_{iss}	$V_{DS} = 25V, V_{GS} = 0V, f = 1MHz$			760	pF
Output capacitance	C_{oss}				180	
Reverse transfer capacitance	C_{riss}				20	
Switching characteristics (note 3)						
Total gate charge	Q_g	$V_{DS} = 480V, V_{GS} = 10V, I_D = 4.0A$		5.0	10	nC
Gate-source charge	Q_{gs}			2.7		
Gate-drain charge	Q_{gd}			2.0		
Turn-on delay time (note3)	$t_{d(on)}$	$V_{DD} = 300V, V_{GS} = 10V, R_G = 9.1\Omega, I_D = 4.0A$			20	ns
Turn-on rise time (note3)	t_r				10	
Turn-off delay time (note3)	$t_{d(off)}$				40	
Turn-off fall time (note3)	t_f				20	

Notes :

1. $L=30mH, I_L=4A, V_{DD}=100V, V_{GS}=10V, R_G=25\Omega, \text{Starting } T_J=25^\circ\text{C}.$
2. Pulse Test : Pulse width $\leq 300\mu s$, duty cycle $\leq 2\%$.
3. These parameters have no way to verify.

Typical Characteristics

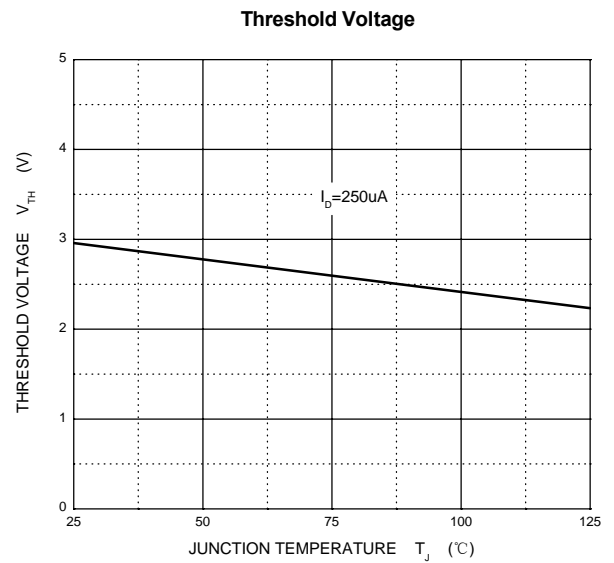
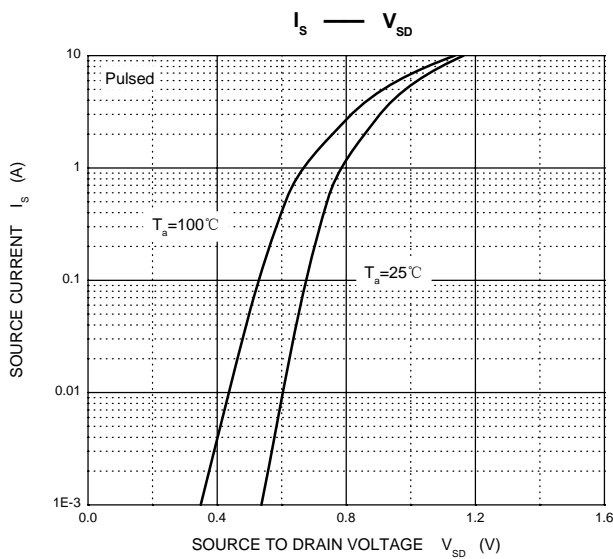
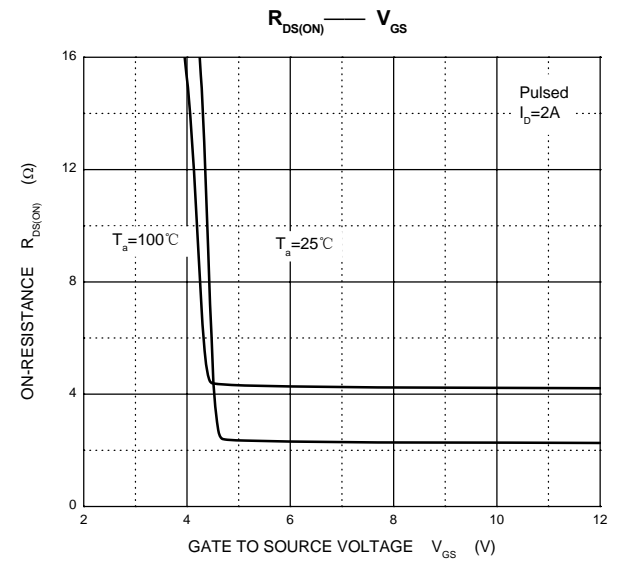
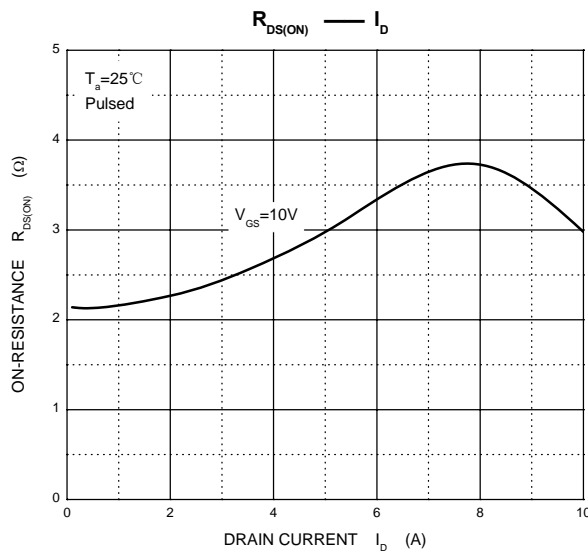
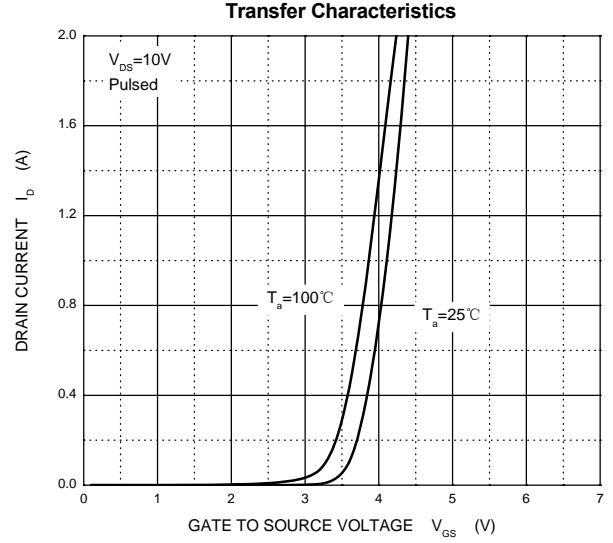
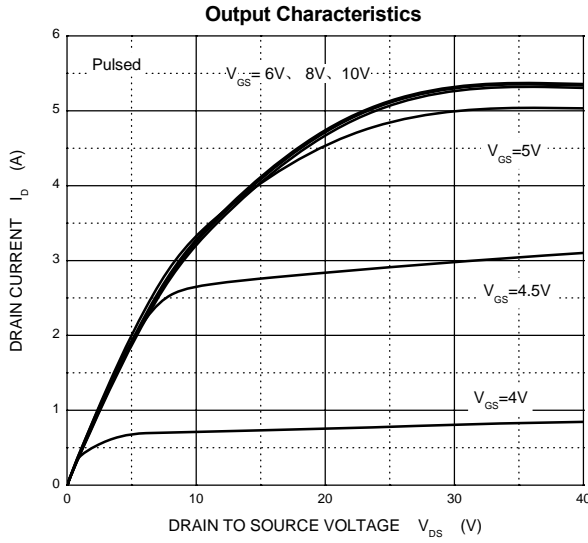

TO-220-3L Package Outline Dimensions

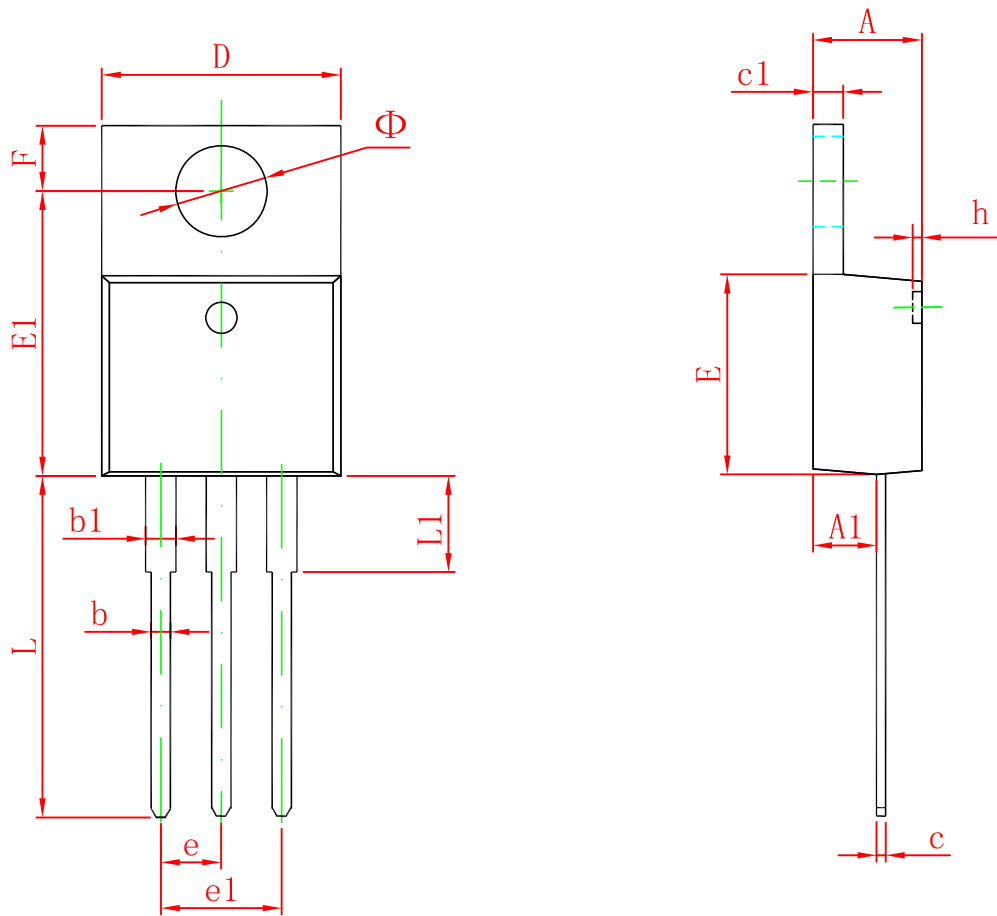

Symbol	Dimensions In Millimeters		Dimensions In Inches	
	Min	Max	Min	Max
A	4.470	4.670	0.176	0.184
A1	2.520	2.820	0.099	0.111
b	0.710	0.910	0.028	0.036
b1	1.170	1.370	0.046	0.054
c	0.310	0.530	0.012	0.021
c1	1.170	1.370	0.046	0.054
D	10.010	10.310	0.394	0.406
E	8.500	8.900	0.335	0.350
E1	12.060	12.460	0.475	0.491
e	2.540 TYP		0.100 TYP	
e1	4.980	5.180	0.196	0.204
F	2.590	2.890	0.102	0.114
h	0.000	0.300	0.000	0.012
L	13.400	13.800	0.528	0.543
L1	3.560	3.960	0.140	0.156
Φ	3.735	3.935	0.147	0.155