



TO-220-3L/TO-220F Plastic-Encapsulate MOSFETS

CJP10N60,CJPF10N60 N-Channel Power MOSFET

Description

The CJP10N60/CJPF10N60 is a high voltage and high current power MOSFET, designed to have characteristics, such as fast switching time, low gate charge, low on-state resistance and rugged avalanche characteristics.

This power MOSFET is usually used at high speed switching applications in power supplies, PWM motor controls, high efficient DC to DC converters and bridge circuits.

FEATURES

- Low C_{rss}
- Fast Switching
- 100% avalanche tested

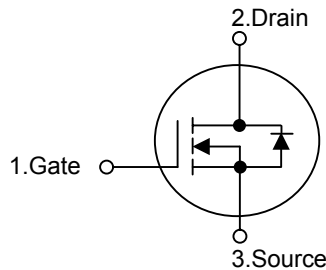
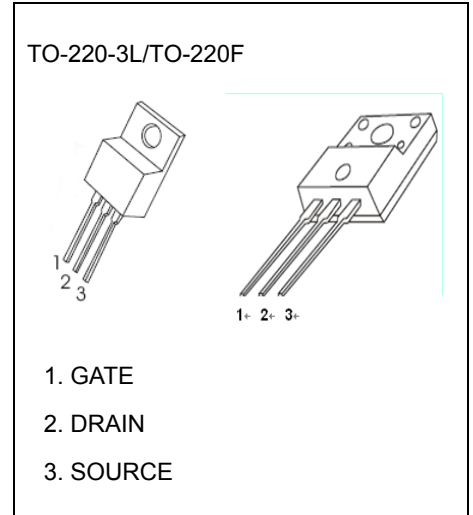

Maximum ratings ($T_a=25^{\circ}\text{C}$ unless otherwise noted)

Parameter	Symbol	Value	Unit
Drain-Source Voltage	V_{DS}	600	V
Gate-Source Voltage	V_{GS}	± 30	
Continuous Drain Current	I_D 10		A
Power Dissipation	P_D 2		W
Thermal Resistance from Junction to Ambient	$R_{\theta JA}$ 62.5		$^{\circ}\text{C/W}$
Junction Temperature	T_J	150	$^{\circ}\text{C}$
Storage Temperature	T_{stg} -50	$\sim +150$	

Electrical characteristics (T_a=25°C unless otherwise noted)

Parameter	Symbol	Test Condition	Min	Typ	Max	Unit
Drain-Source Breakdown Voltage	V _{(BR) DSS}	V _{GS} = 0V, I _D =250μA	600			V
Gate-Threshold Voltage (note1)	V _{GS(th)}	V _{DS} =V _{GS} , I _D =250μA	2.0		4.0	
Gate-Body Leakage Current (note1)	I _{GSS}	V _{DS} =0V, V _{GS} =±30V			±100	nA
Zero Gate Voltage Drain Current	I _{DSS}	V _{DS} =600V, V _{GS} =0V			10	μA
Drain-Source On-State Resistance (note1)	R _{DS(on)}	V _{GS} =10V, I _D =5A			1	Ω
Input Capacitance	C _{iss}	V _{DS} =25V, V _{GS} =0V, f =1MHz		1430		pF
Output Capacitance	C _{oss}			117		
Reverse Transfer Capacitance	C _{rss}			2.2		
Turn-On Delay Time	t _{d(on)}	V _{DD} =325V, I _D =10A, R _G =25Ω		46		ns
Rise Time	t _r			74		
Turn-Off Delay Time	t _{d(off)}			340		
Fall Time	t _f			66		
Forward on Voltage(note1)	V _{SD}	V _{GS} =0V, I _S =10A		1.4		V

Notes:

1. Pulse Test : Pulse Width≤300μs, Duty Cycle ≤2%.

Typical Characteristics

CJP/PF10N60

Output Characteristics

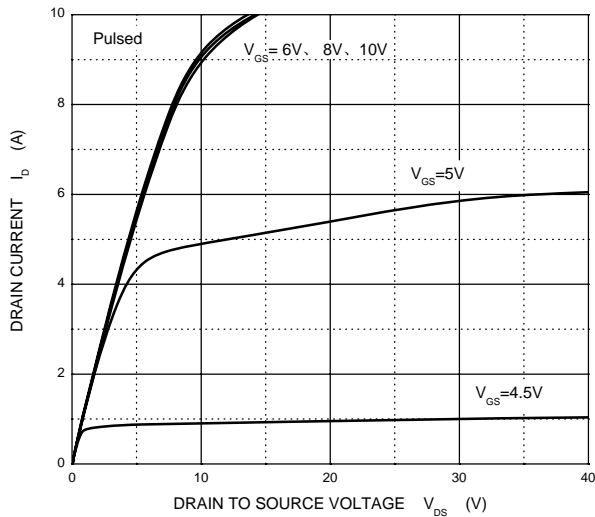

Transfer Characteristics

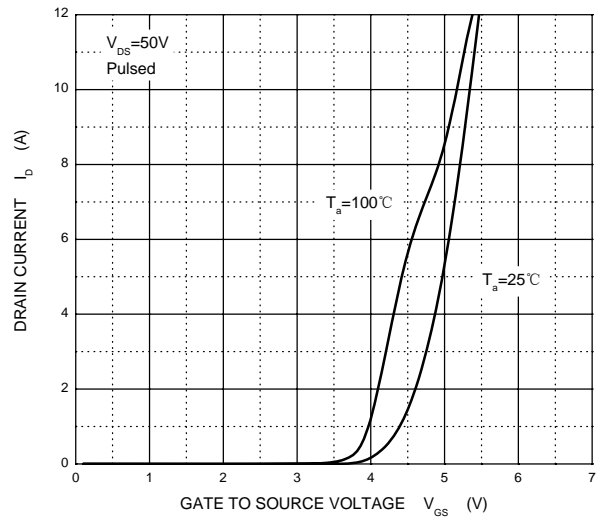

$R_{DS(ON)}$ — I_D

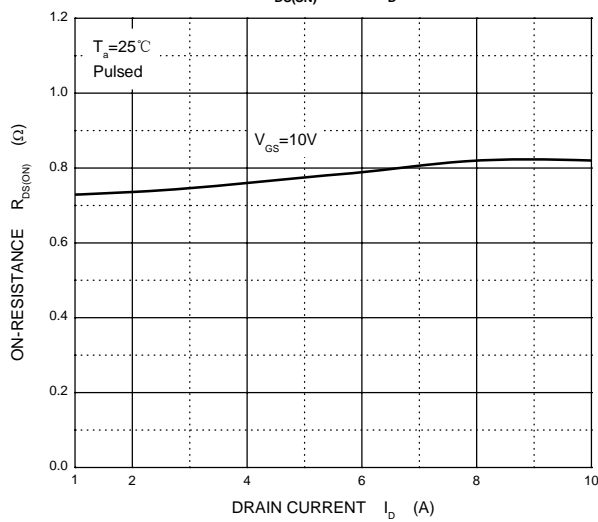

$R_{DS(ON)}$ — V_{GS}

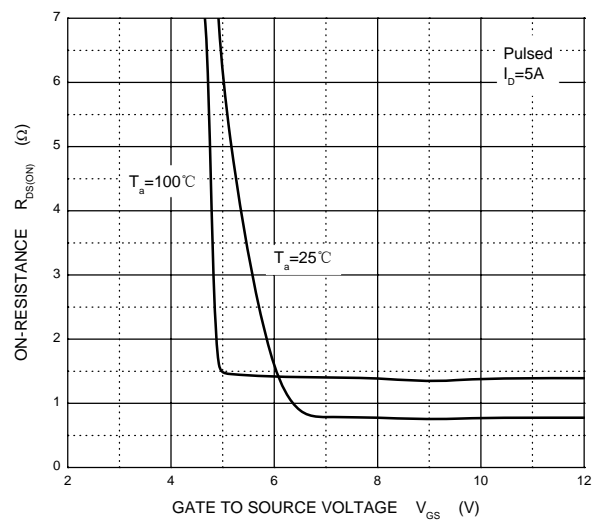

I_S — V_{SD}

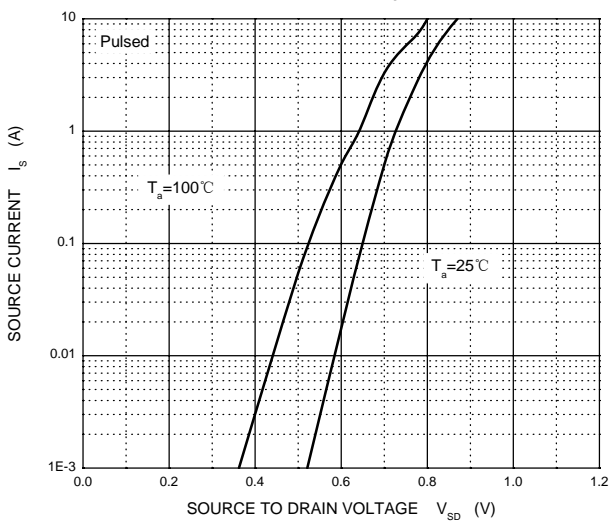

Threshold Voltage

