

TO-220F Plastic-Encapsulate MOSFETS

CJPF02N60 N-Channel Power MOSFET

$V_{(BR)DSS}$	$R_{DS(on)MAX}$	I_D
600V	4.4Ω@10V	2A

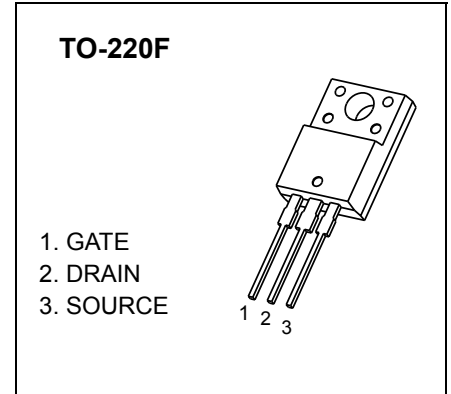

General Description

The high voltage MOSFET uses an advanced termination scheme to provide enhanced voltage-blocking capability without degrading performance over time. In addition, this advanced MOSFET is designed to withstand high energy in avalanche and commutation modes. The new energy efficient design also offers a drain-to-source diode with a fast recovery time. Designed for high voltage, high speed switching applications in power suppliers, converters and PWM motor controls, these devices are particularly well suited for bridge circuits where diode speed and commutating safe operating areas are critical and offer additional and safety margin against unexpected voltage transients.

FEATURES

- Robust High Voltage Termination
- Avalanche Energy Specified
- Source-to-Drain Diode Recovery Time Comparable to a Discrete Fast Recovery Diode
- Diode is Characterized for Use in Bridge Circuits
- I_{DSS} and $V_{DS(on)}$ Specified at Elevated Temperature

MARKING

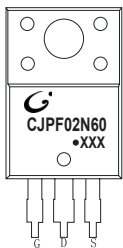

CJPF02N60= Device code
 Solid dot = Green molding compound device,
 if none, the normal device
 XXX=Date Code

EQUIVALENT CIRCUIT

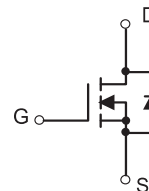

Maximum ratings ($T_a=25^\circ\text{C}$ unless otherwise noted)

Parameter	Symbol	Value	Unit
Drain-Source Voltage	V_{DS}	600	V
Gate-Source Voltage	V_{GS}	±20	
Continuous Drain Current	I_D	2	A
Pulsed Drain Current	I_{DM}	9	
Power Dissipation	P_D	2	W
Single Pulsed Avalanche Energy	E_{AS}^*	128	mJ
Thermal Resistance from Junction to Ambient	$R_{\theta JA}$	62.5	°C/W
Junction Temperature	T_J	150	°C
Storage Temperature	T_{STG}	-55 ~+150	

* E_{AS} condition: $T_J=25^\circ\text{C}$, $V_{DD}=50\text{V}$, $L=64\text{mH}$, $I_L=2\text{A}$, $R_G=25\Omega$

MOSFET ELECTRICAL CHARACTERISTICS

$T_a=25\text{ }^\circ\text{C}$ unless otherwise specified

Parameter	Symbol	Test Condition	Min	Typ	Max	Unit
Drain-Source Breakdown Voltage	$V_{(BR)DSS}$	$V_{GS} = 0V, I_D = 250\mu A$	600			V
Gate-Threshold Voltage (note1)	$V_{GS(th)}$	$V_{DS} = V_{GS}, I_D = 250\mu A$	2.0	3.0	4.0	
Gate-Body Leakage Current (note1)	I_{GSS}	$V_{DS} = 0V, V_{GS} = \pm 20V$			± 100	nA
Zero Gate Voltage Drain Current	I_{DSS}	$V_{DS} = 600V, V_{GS} = 0V$			25	μA
Drain-Source On-State Resistance (note1)	$R_{DS(on)}$	$V_{GS} = 10V, I_D = 1A$		3.8	4.4	Ω
Forward Transconductance (note1)	g_s	$V_{DS} = 50V, I_D = 1A$	1			S
Input Capacitance (note 2)	C_{iss}	$V_{DS} = 25V, V_{GS} = 0V,$ $f = 1MHz$		435		pF
Output Capacitance (note 2)	C_{oss}			56		
Reverse Transfer Capacitance (note 2)	C_{rss}			9.2		
Turn-On Delay Time (note 2)	$t_{d(on)}$	$V_{DD} = 300V, I_D = 2A,$ $V_{GS} = 10V, R_G = 18\Omega$		12		ns
Rise Time (note 2)	t_r			21		
Turn-Off Delay Time (note 2)	$t_{d(off)}$			30		
Fall Time (note 2)	t_f			24		
Forward on Voltage(note1)	V_{SD}	$V_{GS} = 0V, I_S = 2A$			1.6	V

Notes:

1. Pulse Test : Pulse width $\leq 300\mu s$, duty cycle $\leq 2\%$.
2. These parameters have no way to verify.

Typical Characteristics

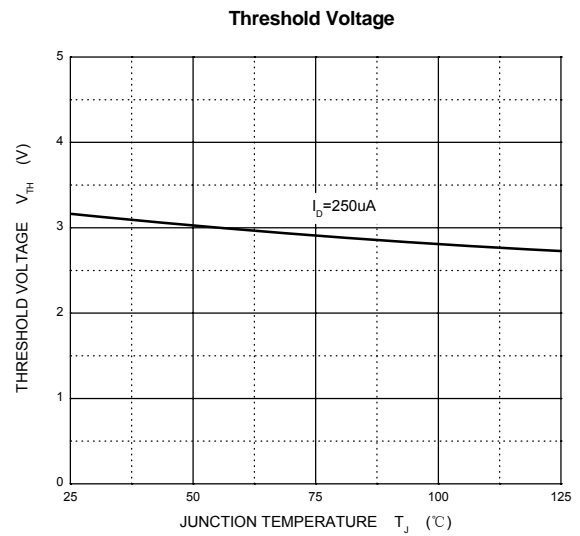
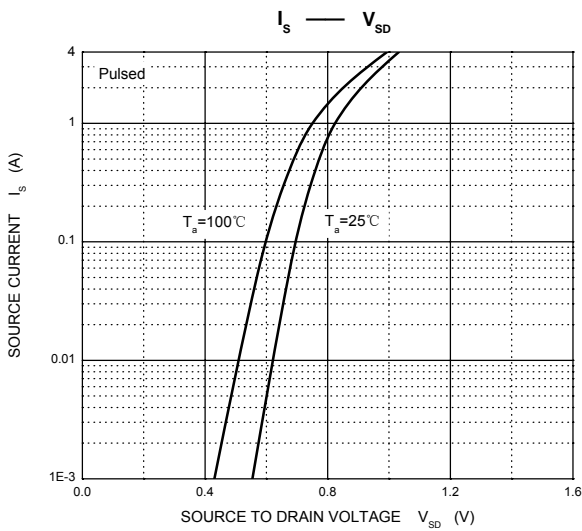
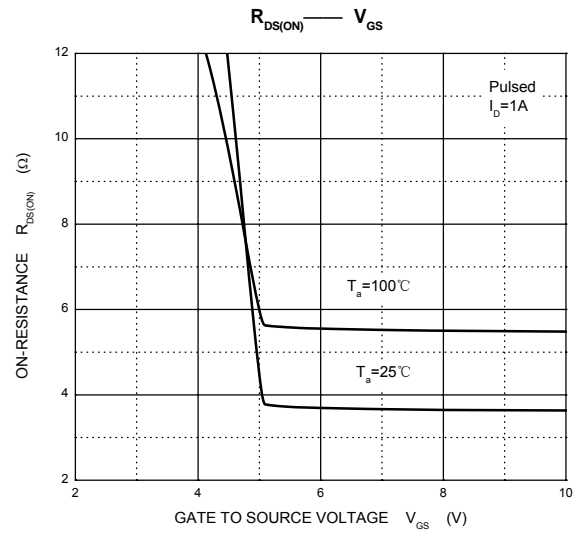
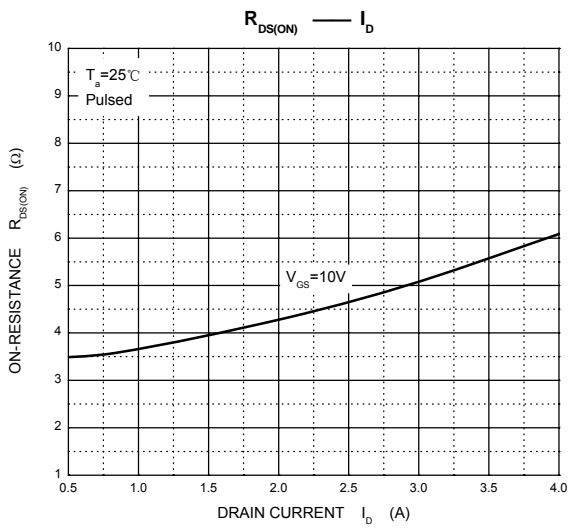
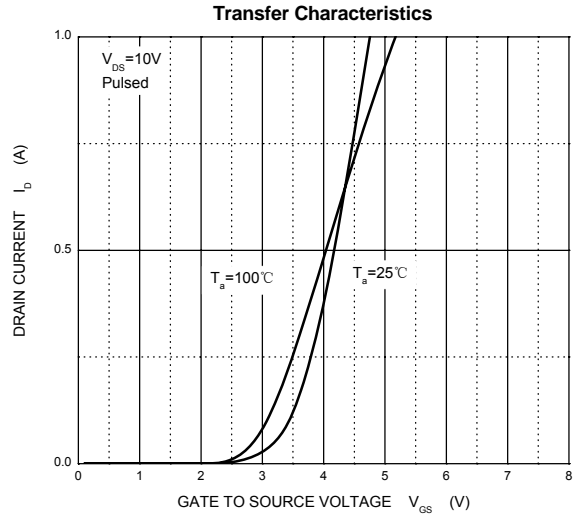
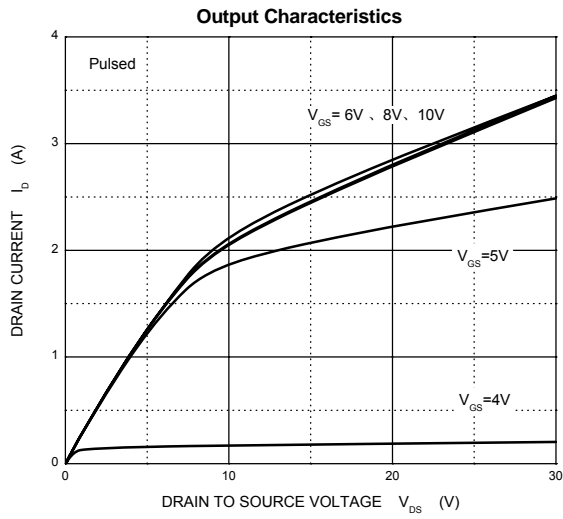

TO-220F Package Outline Dimensions

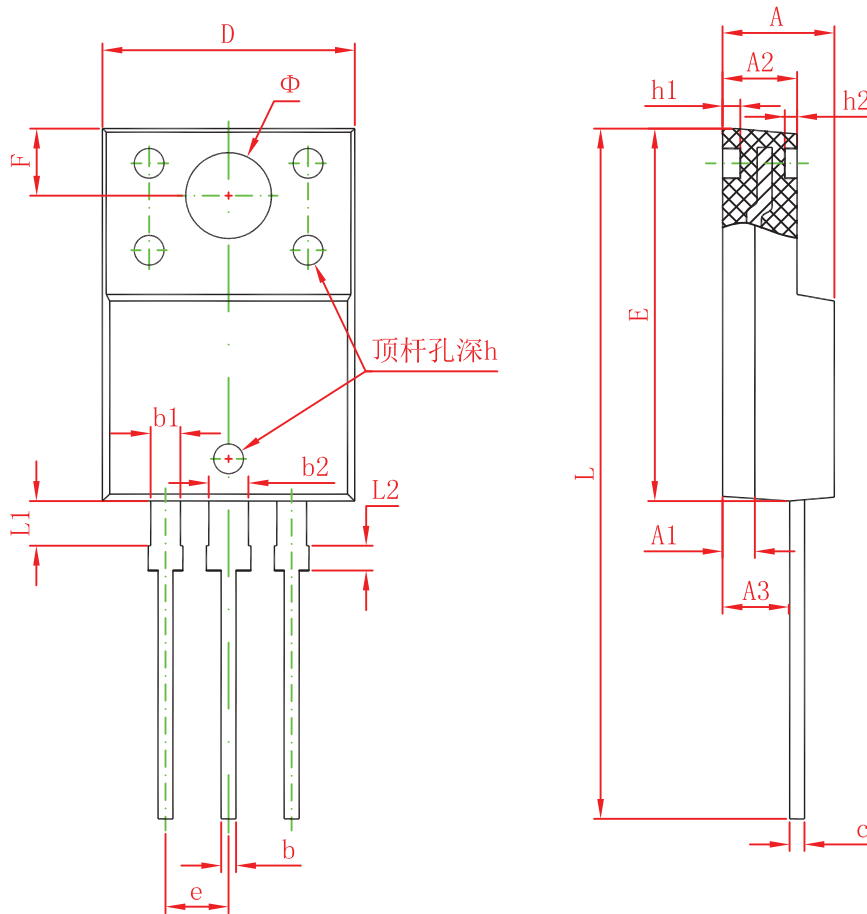

Symbol	Dimensions In Millimeters		Dimensions In Inches	
	Min.	Max.	Min.	Max.
A	4.300	4.700	0.169	0.185
A1	1.300 REF.		0.051 REF.	
A2	2.800	3.200	0.110	0.126
A3	2.500	2.900	0.098	0.114
b	0.500	0.750	0.020	0.030
b1	1.100	1.350	0.043	0.053
b2	1.500	1.750	0.059	0.069
c	0.500	0.750	0.020	0.030
D	9.960	10.360	0.392	0.408
E	14.800	15.200	0.583	0.598
e	2.540 TYP.		0.100 TYP.	
F	2.700 REF.		0.106 REF.	
Φ	3.500 REF.		0.138 REF.	
h	0.000	0.300	0.000	0.012
h1	0.800 REF.		0.031 REF.	
h2	0.500 REF.		0.020 REF.	
L	28.000	28.400	1.102	1.118
L1	1.700	1.900	0.067	0.075
L2	0.900	1.100	0.035	0.043