

TO-220F Plastic-Encapsulate MOSFETS

CJPF02N65

N-Channel Power MOSFET

$V_{(BR)DSS}$	$R_{DS(on)MAX}$	I_D
650V	4.4Ω@10V	2A

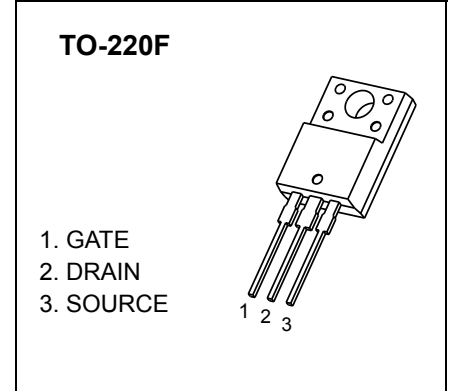

GENERAL DESCRIPTION

This advanced high voltage MOSFET is designed to stand high energy in the avalanche mode and switch efficiently. This new high energy device also offers a drain-to-source diode fast recovery time. Designed for high voltage, high speed switching applications such as power supplies, converters, power motor controls and bridge circuits.

FEATURE

- High Current Rating
- Lower $R_{DS(on)}$
- Lower Capacitance
- Lower Total Gate Charge
- Tighter V_{SD} Specifications
- Avalanche Energy Specified

MARKING

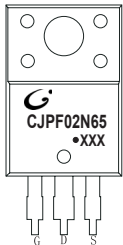

CJPF02N65= Device code
 Solid dot = Green molding compound device,
 if none, the normal device
 XXX=Date Code

EQUIVALENT CIRCUIT

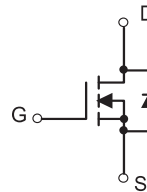

Maximum ratings ($T_a=25^{\circ}C$ unless otherwise noted)

Parameter	Symbol	Value	Unit
Drain-Source Voltage	V_{DS}	650	V
Gate-Source Voltage	V_{GSS}	±20	
Continuous Drain Current	I_D	2	A
Pulsed Drain Current	I_{DM}	8	
Single Pulsed Avalanche Energy (note1)	E_{AS}	128	mJ
Power Dissipation	P_D	2	W
Thermal Resistance from Junction to Ambient	$R_{\theta JA}$	62.5	°C/W
Operating and Storage Temperature Range	T_J, T_{STG}	-55 ~+150	°C
Maximum lead temperature for soldering purposes , 1/8"from case for 5 seconds	T_L	260	

MOSFET ELECTRICAL CHARACTERISTICS

$T_a=25\text{ }^\circ\text{C}$ unless otherwise specified

Parameter	Symbol	Test Condition	Min	Typ	Max	Unit
Off characteristics						
Drain-source breakdown voltage	$V_{(BR)DSS}$	$V_{GS} = 0V, I_D = 250\mu A$	650			V
Drain-source diode forward voltage(note2)	V_{SD}	$V_{GS} = 0V, I_S = 2A$			1.6	
Zero gate voltage drain current	I_{DSS}	$V_{DS} = 600V, V_{GS} = 0V$			250	μA
Gate-body leakage curren (note2)	I_{GSS}	$V_{DS} = 0V, V_{GS} = \pm 20V$			± 100	nA
On characteristics (note2)						
Gate-threshold voltage	$V_{GS(th)}$	$V_{DS} = V_{GS}, I_D = 250\mu A$	2.0	3.0	4.0	V
Static drain-source on-resistance	$R_{DS(on)}$	$V_{GS} = 10V, I_D = 1A$		3.8	4.4	Ω
Dynamic characteristics (note 3)						
Input capacitance	C_{iss}	$V_{DS} = 25V, V_{GS} = 0V, f = 1MHz$		435		pF
Output capacitance	C_{oss}			56		
Reverse transfer capacitance	C_{rss}			9.2		
Switching characteristics (note 3)						
Total gate charge	Q_g	$V_{DS} = 480V, V_{GS} = 10V, I_D = 4.0A$		5.0	10	nC
Gate-source charge	Q_{gs}			2.7		
Gate-drain charge	Q_{gd}			2.0		
Turn-on delay time (note3)	$t_{d(on)}$	$V_{DD} = 300V, V_{GS} = 10V,$ $R_G = 18\Omega, I_D = 2A$		12		ns
Turn-on rise time (note3)	t_r			21		
Turn-off delay time (note3)	$t_{d(off)}$			30		
Turn-off fall time (note3)	t_f			24		

Notes :

1. $L=64mH, I_L=2A, V_{DD}=50V, R_G=25\Omega$, Starting $T_J=25^\circ C$.
2. Pulse Test : Pulse width $\leq 300\mu s$, duty cycle $\leq 2\%$.
3. These parameters have no way to verify.

Typical Characteristics

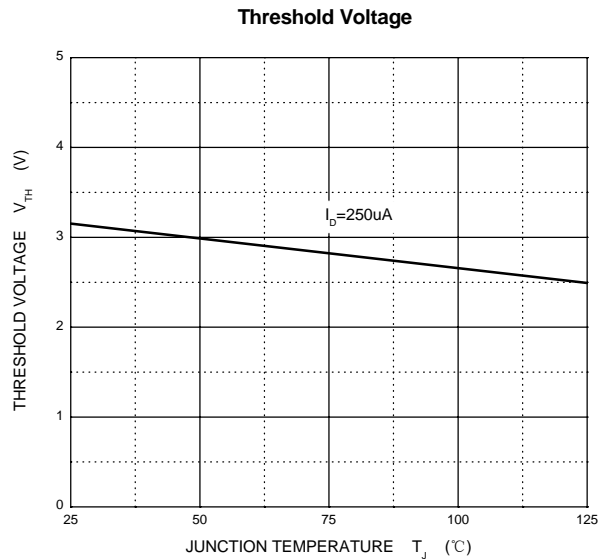
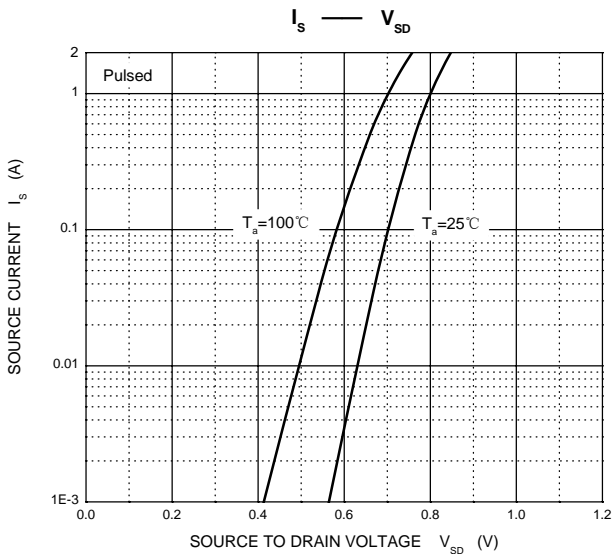
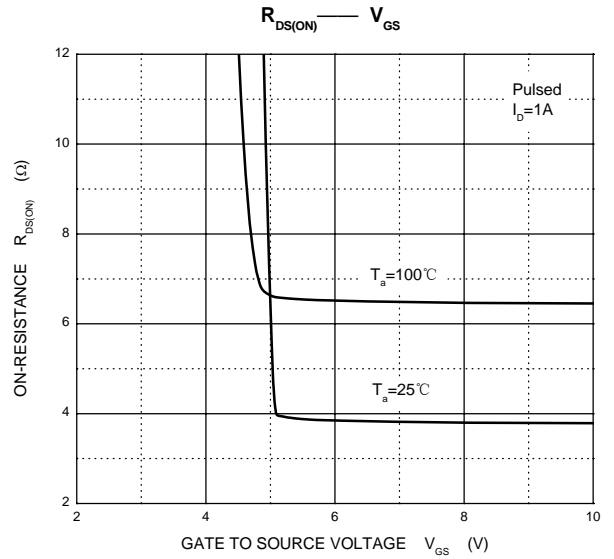
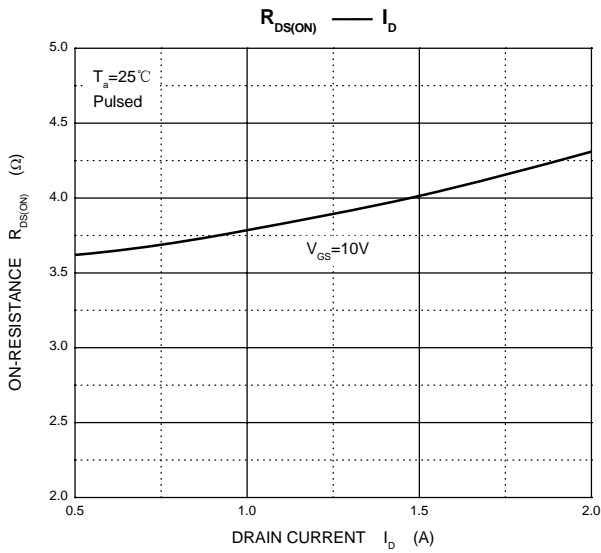
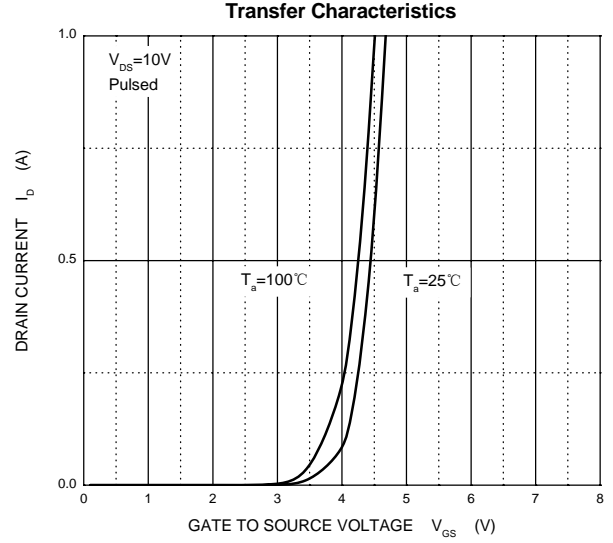
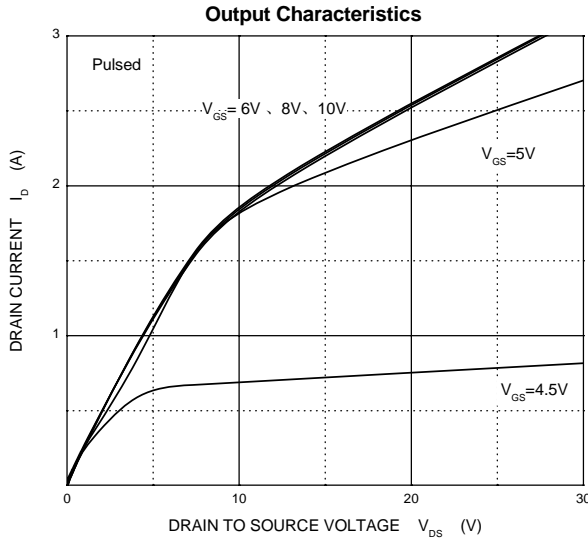

TO-220F Package Outline Dimensions

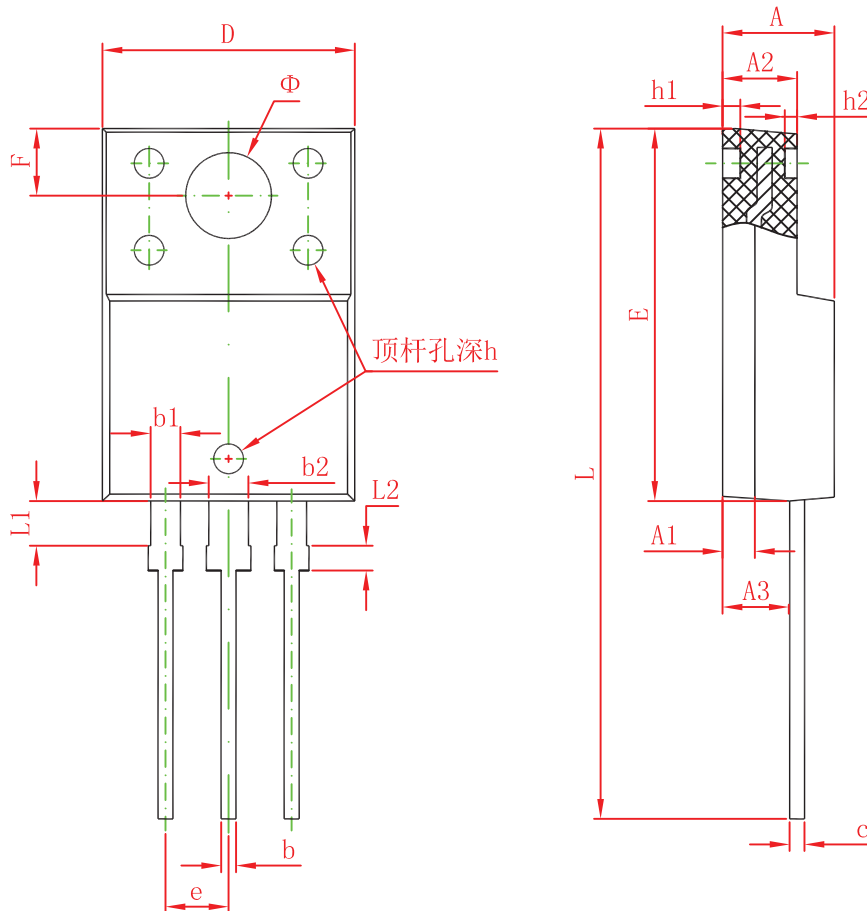

Symbol	Dimensions In Millimeters		Dimensions In Inches	
	Min.	Max.	Min.	Max.
A	4.300	4.700	0.169	0.185
A1	1.300 REF.		0.051 REF.	
A2	2.800	3.200	0.110	0.126
A3	2.500	2.900	0.098	0.114
b	0.500	0.750	0.020	0.030
b1	1.100	1.350	0.043	0.053
b2	1.500	1.750	0.059	0.069
c	0.500	0.750	0.020	0.030
D	9.960	10.360	0.392	0.408
E	14.800	15.200	0.583	0.598
e	2.540 TYP.		0.100 TYP.	
F	2.700 REF.		0.106 REF.	
Φ	3.500 REF.		0.138 REF.	
h	0.000	0.300	0.000	0.012
h1	0.800 REF.		0.031 REF.	
h2	0.500 REF.		0.020 REF.	
L	28.000	28.400	1.102	1.118
L1	1.700	1.900	0.067	0.075
L2	0.900	1.100	0.035	0.043