

SOP8 Plastic-Encapsulate MOSFETS

CJQ4559 N Channel +P Channel MOSFET

$V_{(BR)DSS}$	$R_{DS(on)MAX}$	I_D
60V	58mΩ@10V	4.5A
	72mΩ@4.5V	
-60V	80mΩ@-10V	-3.5A
	100mΩ@-4.5V	

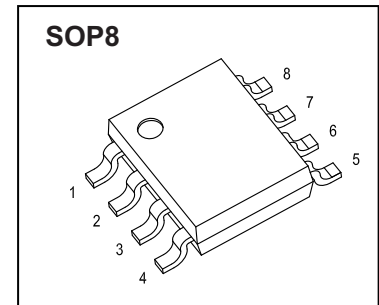

FEATURE

- Surface Mount Package
- Super High Density Cell Design for Extremely Low $R_{DS(ON)}$

APPLICATION

- CCFL Inverter

MARKING

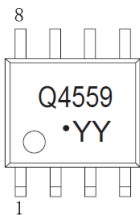

Q4559= Device code
 YY=Date Code
 Solid dot = Pin1 indicator
 Solid dot = Green molding compound device, if none,the normal device.

Equivalent Circuit

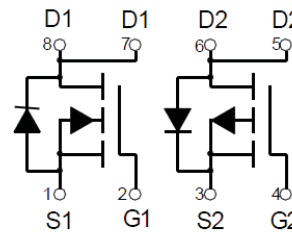

ABSOLUTE MAXIMUM RATINGS ($T_a=25^{\circ}C$ unless otherwise noted)

Parameter	Symbol	Value	Unit
N-MOSFET			
Drain-Source Voltage	V_{DS}	60	V
Gate-Source Voltage	V_{GS}	±20	V
Continuous Drain Current (note 1)	I_D	4.5	A
Pulsed Drain Current ($t_p=10\mu s$)	I_{DM}	18	A
Continous Source-Drain Diode Current	I_S	4.5	A
P-MOSFET			
Drain-Source Voltage	V_{DS}	-60	V
Gate-Source Voltage	V_{GS}	±20	V
Continuous Drain Current (note 1)	I_D	-3.5	A
Pulsed Drain Current ($t_p=10\mu s$)	I_{DM}	-14	A
Continous Source-Drain Diode Current	I_S	-3.5	A
Temperature and Thermal Resistance			
Power Dissipation	P_D	2	W
Thermal Resistance from Junction to Ambient (note 1)	$R_{\theta JA}$	62.5	$^{\circ}C/W$
Junction Temperature	T_J	150	$^{\circ}C$
Storage Temperature	T_{STG}	-55~+150	$^{\circ}C$
Lead Temperature for Soldering Purposes(1/8" from case for 10 s)	T_L	260	$^{\circ}C$

MOSFET ELECTRICAL CHARACTERISTICS

N-ch MOSFET ELECTRICAL CHARACTERISTICS($T_a=25^{\circ}\text{C}$ unless otherwise noted)

Parameter	Symbol	Test Condition	Min	Typ	Max	Unit
STATIC CHARACTERISTICS						
Drain-source breakdown voltage	$V_{(BR)DSS}$	$V_{GS} = 0V, I_D = 250\mu A$	60			V
Zero gate voltage drain current	I_{DSS}	$V_{DS} = 60V, V_{GS} = 0V$			1	μA
Gate-body leakage current	I_{GSS}	$V_{GS} = \pm 20V, V_{DS} = 0V$			± 100	nA
Gate threshold voltage (note 2)	$V_{GS(th)}$	$V_{DS} = V_{GS}, I_D = 250\mu A$	1	2.1	3	V
Drain-source on-resistance(note 2)	$R_{DS(on)}$	$V_{GS} = 10V, I_D = 4.3A$		40	58	m Ω
		$V_{GS} = 4.5V, I_D = 3.9A$		55	72	m Ω
Forward tranconductance(note 2)	g_{FS}	$V_{DS} = 15V, I_D = 4.3A$		15		S
Diode forward voltage	V_{SD}	$I_S = 1.7A, V_{GS} = 0V$			1.2	V
DYNAMIC CHARACTERISTICS (note 4)						
Input Capacitance	C_{iss}	$V_{DS} = 15V, V_{GS} = 0V, f = 1MHz$		665		pF
Output Capacitance	C_{oss}			75		pF
Reverse Transfer Capacitance	C_{rss}			40		pF
Gate Resistance	R_g	$f = 1MHz$			3	Ω
SWITCHING CHARACTERISTICS (note 3,4)						
Turn-on delay time	$t_{d(on)}$	$V_{GEN} = 4.5V, V_{DD} = 30V, I_D = 3.4A, R_G = 1\Omega, R_L = 8.8\Omega$			25	ns
Turn-on rise time	t_r				100	ns
Turn-off delay time	$t_{d(off)}$				25	ns
Turn-off fall time	t_f				15	ns
Total Gate Charge	Q_g	$V_{DS} = 30V, I_D = 4.3A, V_{GS} = 4.5V$			9	nC
Gate-Source Charge	Q_{gs}			2.3		nC
Gate-Drain Charge	Q_{gd}			2.6		nC

P-ch MOSFET ELECTRICAL CHARACTERISTICS($T_a=25^{\circ}\text{C}$ unless otherwise noted)

Parameter	Symbol	Test Condition	Min	Typ	Max	Unit
STATIC CHARACTERISTICS						
Drain-source breakdown voltage	$V_{(BR)DSS}$	$V_{GS} = 0V, I_D = -250\mu A$	-60			V
Zero gate voltage drain current	I_{DSS}	$V_{DS} = -60V, V_{GS} = 0V$			-1	μA
Gate-body leakage current	I_{GSS}	$V_{GS} = \pm 20V, V_{DS} = 0V$			± 100	nA
Gate threshold voltage (note 2)	$V_{GS(th)}$	$V_{DS} = V_{GS}, I_D = -250\mu A$	-1	-2.8	-3	V
Drain-source on-resistance(note 2)	$R_{DS(on)}$	$V_{GS} = -10V, I_D = -3.1A$		60	80	m Ω
		$V_{GS} = -4.5V, I_D = -0.2A$		92	100	m Ω
Forward tranconductance(note 2)	g_{FS}	$V_{DS} = -15V, I_D = -3.1A$		8.5		S
Diode forward voltage	V_{SD}	$I_S = -2A, V_{GS} = 0V$			-1.2	V
DYNAMIC CHARACTERISTICS (note 4)						
Input Capacitance	C_{iss}	$V_{DS} = -15V, V_{GS} = 0V, f = 1MHz$		650		pF
Output Capacitance	C_{oss}			95		pF
Reverse Transfer Capacitance	C_{rss}			60		pF
Gate Resistance	R_g	$f = 1MHz$			20	Ω
SWITCHING CHARACTERISTICS (note 3,4)						
Turn-on delay time	$t_{d(on)}$	$V_{GEN} = -4.5V, V_{DD} = -30V, I_D = -2.4A, R_G = 1\Omega, R_L = 12.5\Omega$			45	ns
Turn-on rise time	t_r				105	ns
Turn-off delay time	$t_{d(off)}$				60	ns
Turn-off fall time	t_f				45	ns
Total Gate Charge	Q_g	$V_{DS} = -30V, I_D = -3.1A, V_{GS} = -4.5V$			12	nC
Gate-Source Charge	Q_{gs}			2.2		nC
Gate-Drain Charge	Q_{gd}			3.7		nC

Notes :

1. Surface mounted on FR4 board using the minimum recommended pad size.
2. Pulse Test : Pulse width=300 μ s, duty cycle \leq 2%.
3. Switching characteristics are independent of operating junction temperature.
4. Guaranteed by design, not subject to producing.

Typical Characteristics

N-Channel MOS

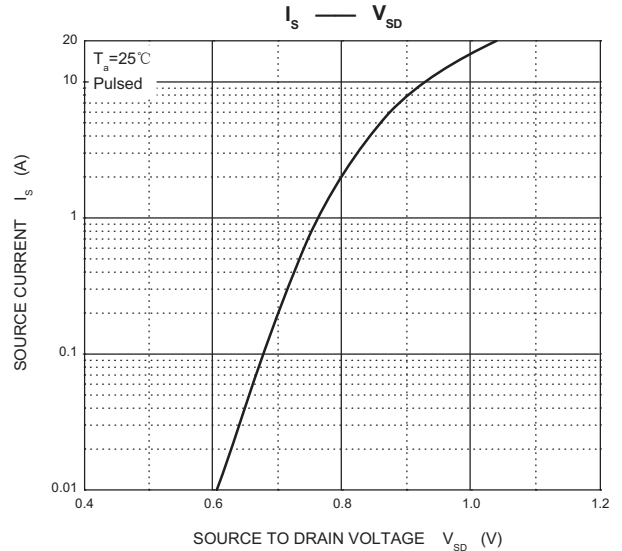
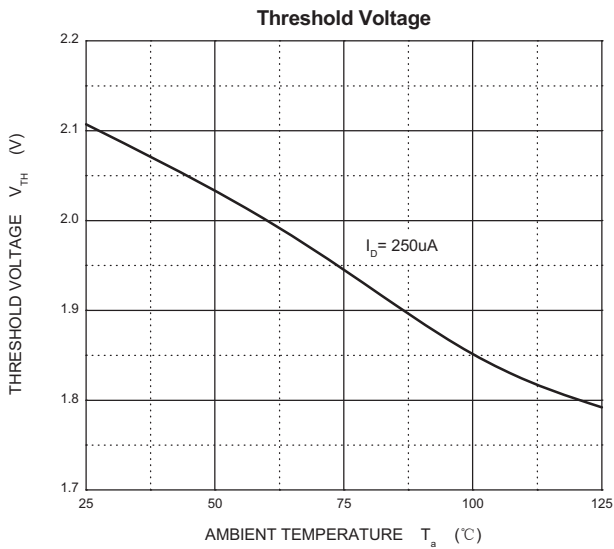
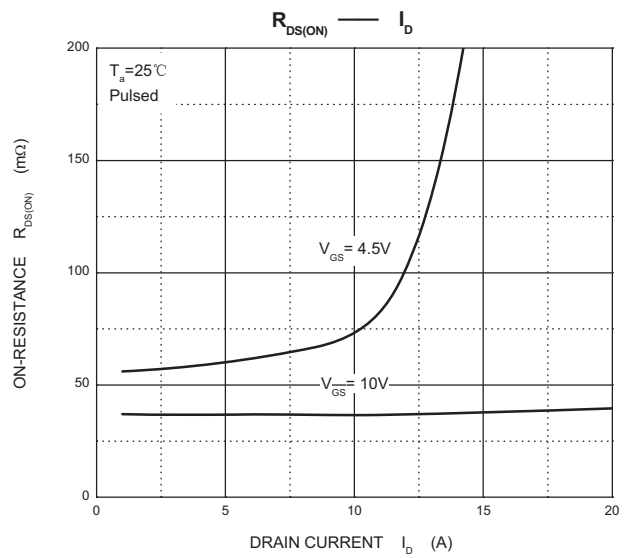
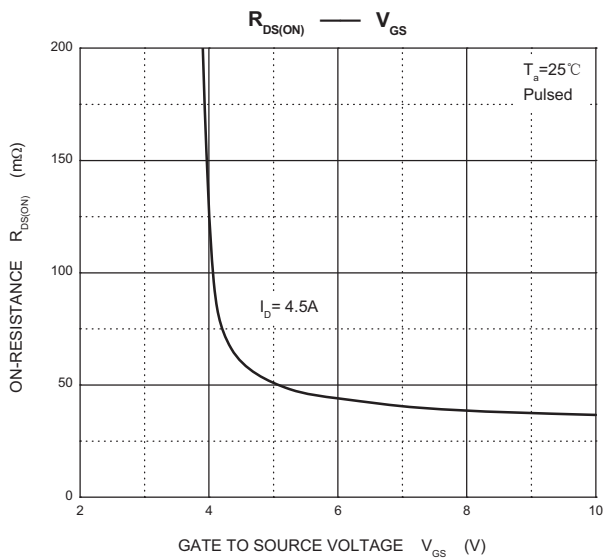
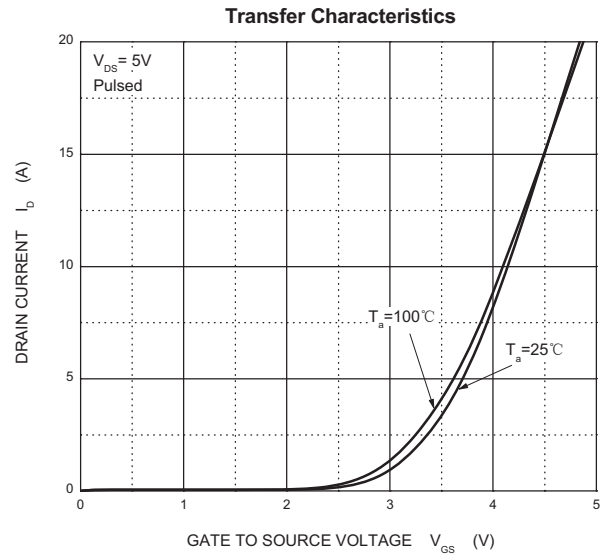
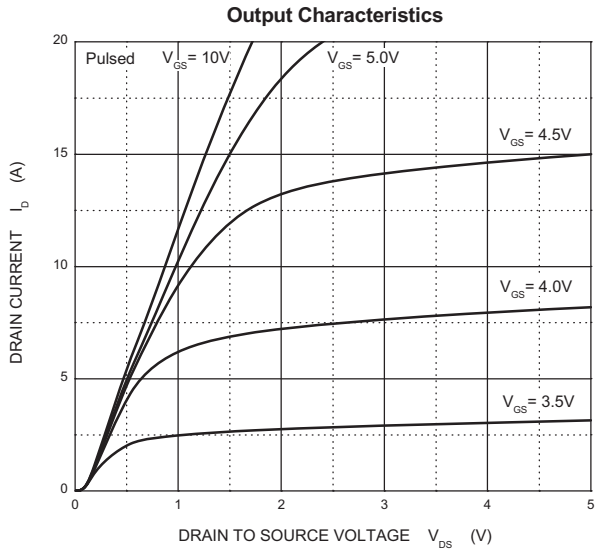

Typical Characteristics

P-Channel MOS

Output Characteristics

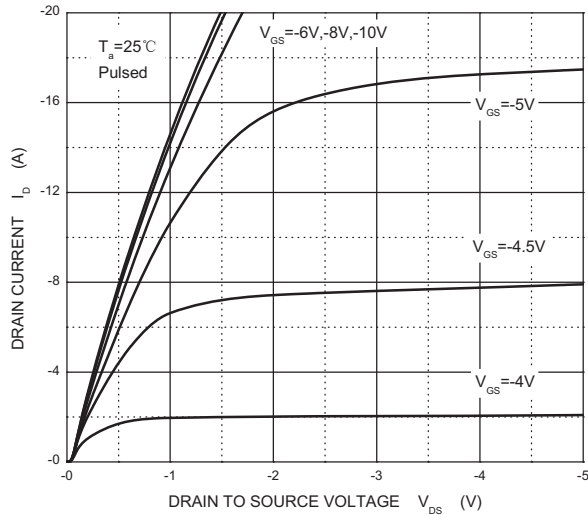

Transfer Characteristics

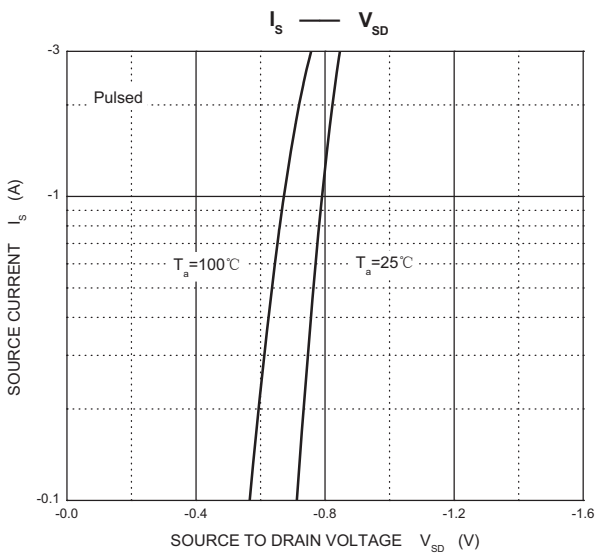
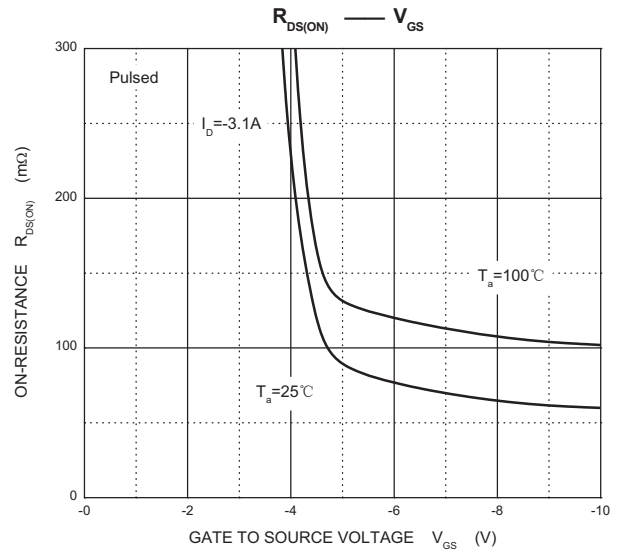
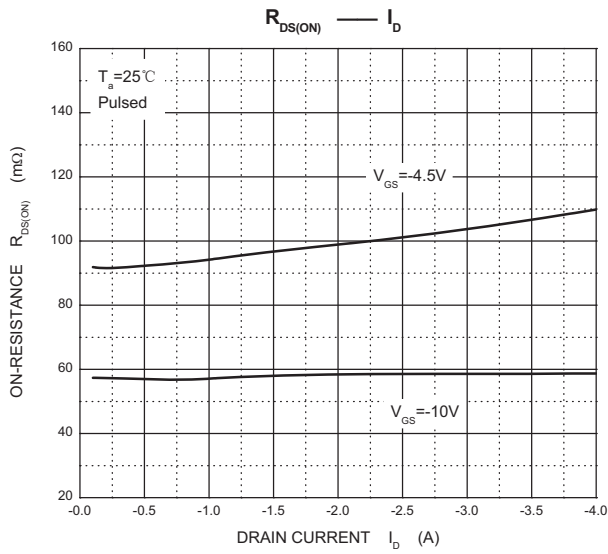
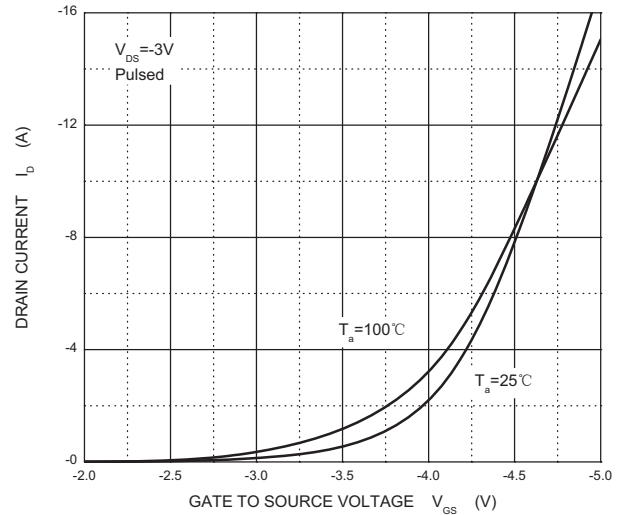

Threshold Voltage

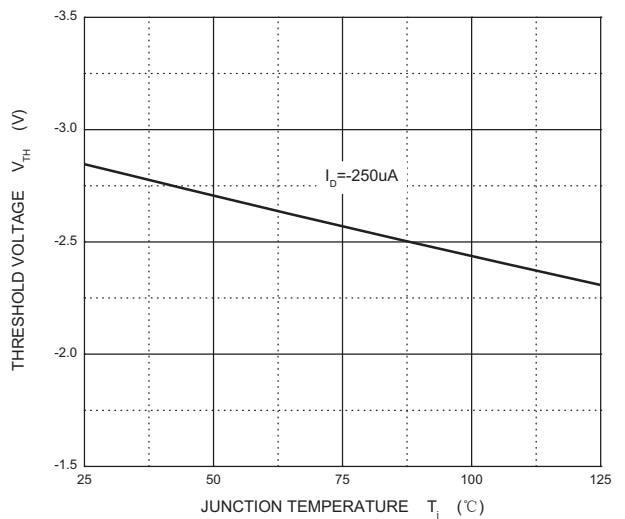

SOP8 Package Outline Dimensions

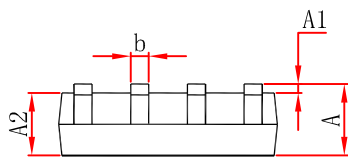
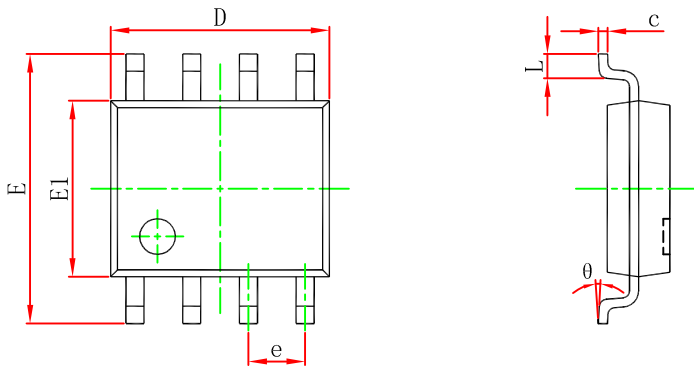

Symbol	Dimensions In Millimeters		Dimensions In Inches	
	Min	Max	Min	Max
A	1.350	1.750	0.053	0.069
A1	0.100	0.250	0.004	0.010
A2	1.350	1.550	0.053	0.061
b	0.330	0.510	0.013	0.020
c	0.170	0.250	0.007	0.010
D	4.800	5.000	0.189	0.197
e	1.270 (BSC)		0.050 (BSC)	
E	5.800	6.200	0.228	0.244
E1	3.800	4.000	0.150	0.157
L	0.400	1.270	0.016	0.050
θ	0°	8°	0°	8°

SOP8 Suggested Pad Layout

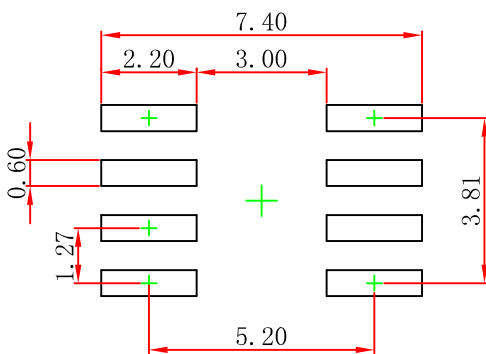

- Note:
1. Controlling dimension: in millimeters.
 2. General tolerance: $\pm 0.05\text{mm}$.
 3. The pad layout is for reference purposes only.

NOTICE

JCET reserve the right to make modifications, enhancements, improvements, corrections or other changes without further notice to any product herein. JCET does not assume any liability arising out of the application or use of any product described herein.

SOP8 Tape and Reel

SOP8 Embossed Carrier Tape

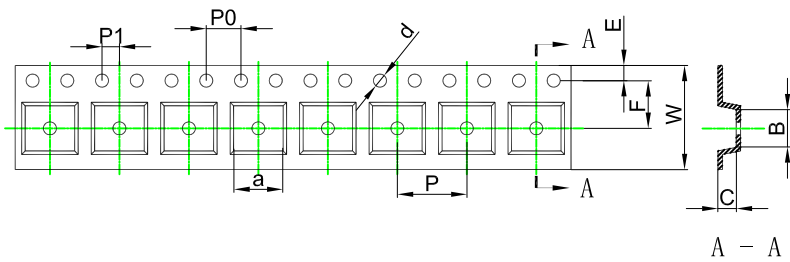

Packaging Description:

SOP8 parts are shipped in tape. The carrier tape is made from a dissipative (carbon filled) polycarbonate resin. The cover tape is a multilayer film (Heat Activated Adhesive in nature) primarily composed of polyester film, adhesive layer, sealant, and anti-static sprayed agent. These reeled parts in standard option are shipped with 2,500 units per 13" or 33cm diameter reel. The reels are clear in color and is made of polystyrene plastic (anti-static coated).

ALL DIM IN mm

Dimensions are in millimeter										
Pkg type	a	B	C	d	E	F	P0	P	P1	W
SOP8	6.40	5.40	2.10	Ø1.50	1.75	5.50	4.00	8.00	2.00	12.00

SOP8 Tape Leader and Trailer

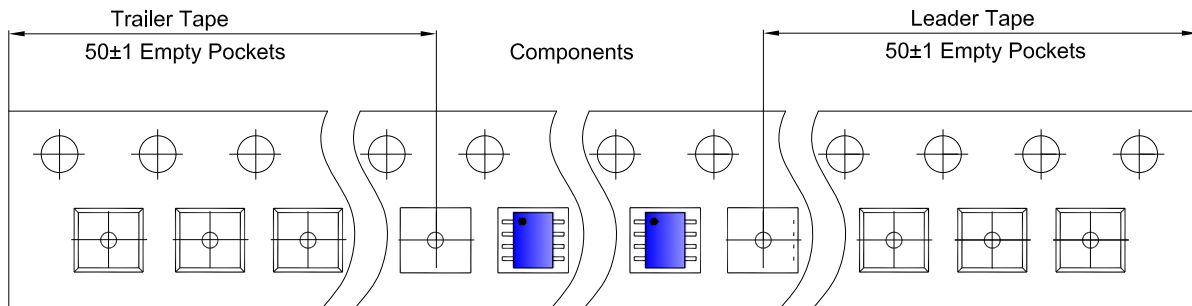

SOP8 Reel

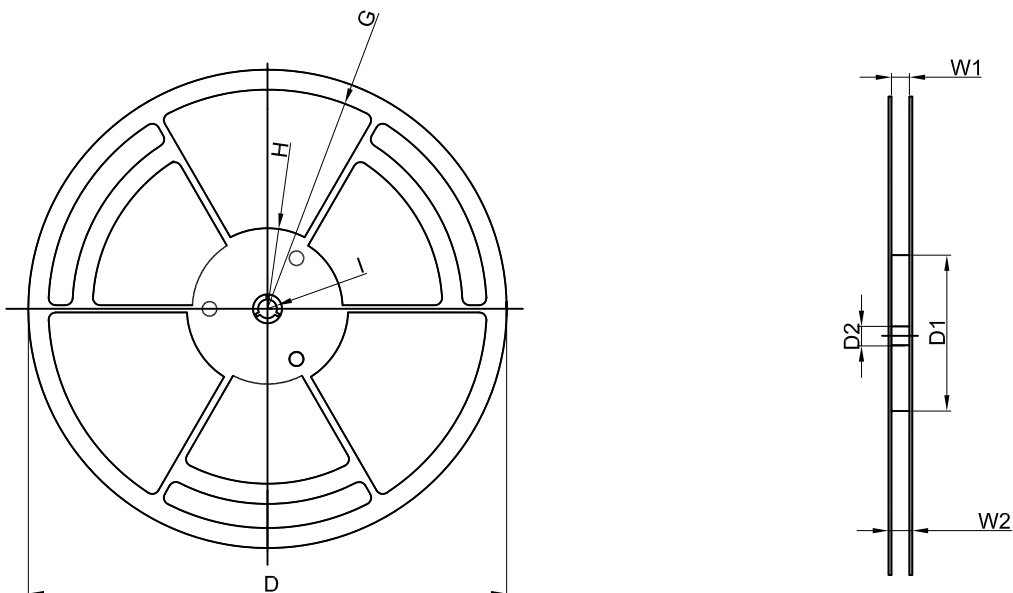

Dimensions are in millimeter								
Reel Option	D	D1	D2	G	H	I	W1	W2
13" Dia	Ø330.00	100.00	13.00	R151.00	R56.00	R6.50	12.40	17.60

REEL	Reel Size	Box	Box Size(mm)	Carton	Carton Size(mm)	G.W.(kg)
4,000 pcs	13 inch	8,000 pcs	360×360×65	64,000 pcs	565×380×390	