

CL - 211

The CL - 211 is a high - power GaAlAs IRED mounted in a durable, hermetically sealed TO - 18 metal can package. The output power is high compared to GaAs IREDs.

FEATURES

- High output power
- High reliability

APPLICATIONS

- Optical switches
- Transportation sensors

DIMENSIONS

(Unit : mm)

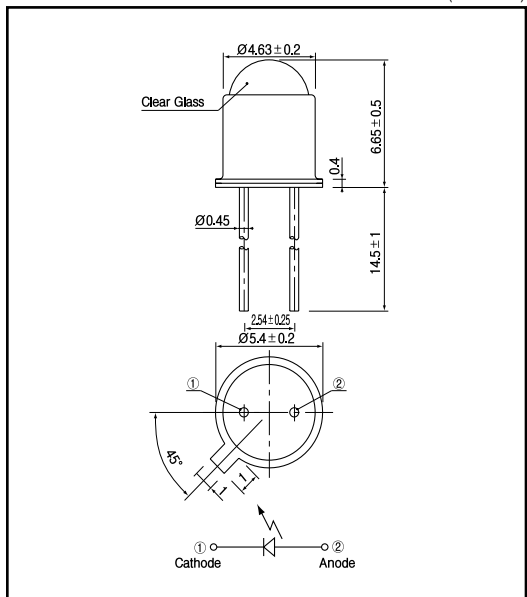

MAXIMUM RATINGS

(Ta=25)

Item	Symbol	Rating	Unit
Reverse voltage	V_R	4	V
Forward current	I_F	50	mA
Power dissipation	P_o	70	mW
Pulse forward current *1	I_{FP}	0.5	A
Operating temp.	$T_{opr.}$	- 30 +85	
Storage temp.	$T_{stg.}$	- 40 +100	
Soldering temp. *2	$T_{sol.}$	260	

*1. pulse width : t_w 100 μ sec.period : $T=10$ msec.

*2. For MAX.5 seconds at the position of 2 mm from the package

ELECTRO-OPTICAL CHARACTERISTICS

(Ta=25)

Item	Symbol	Conditions	Min.	Typ.	Max.	Unit.
Forward voltage	V_F	$I_F=20$ mA		1.3	1.6	V
Reverse current	I_R	$V_R=4$ V			10	μ A
Peak emission wavelength	λ_p	$I_F=20$ mA		870		nm
Spectral bandwidth		$I_F=20$ mA		45		nm
Radiant intensity	P_o	$I_F=20$ mA		90		mV
Half angle				± 12		deg.

Infrared Emitting Diodes(GaAlAs)

CL - 211

Power dissipation Vs. Ambient temperature

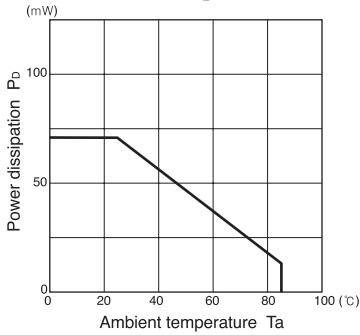

Radiant intensity Vs. Forward current

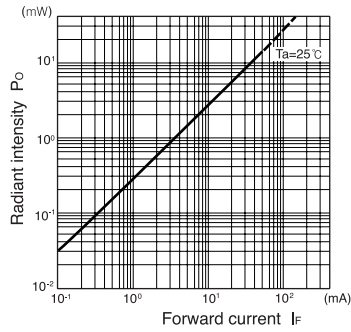

Relative radiant intensity Vs. Ambient temperature

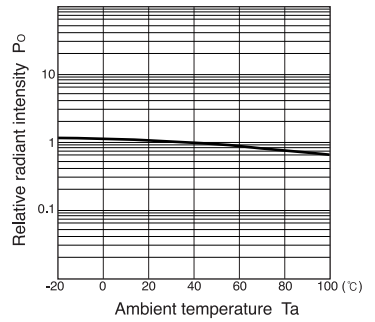

Relative intensity Vs. Wavelength

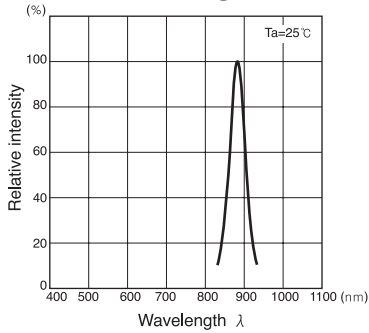

Forward current Vs. Forward voltage

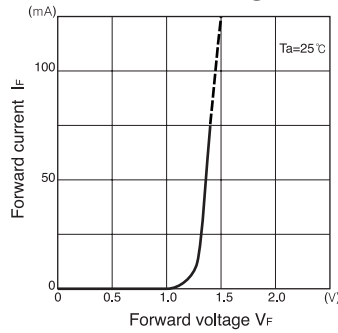

Radiant Pattern

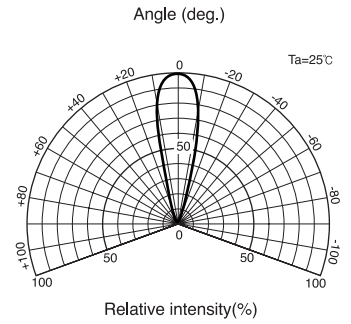

Relative radiant intensity Vs. Distance

