

## Product Features

- GaAs p-HEMT chip on board
- No matching circuit needed
- High Maximum input power(+25dBm)
- High IP3 & Low Noise
- Single Supply Voltage (+5V)
- Surface Mount Hybrid Type
- Tape & Reel Packaging
- Small Size, High Heatsink
- Alumina Substrate
- Pb Free / RoHS Standard

## Applications

- 2G & 3G Repeater
- Base Station
- PCS, CDMA, W-CDMA
- GSM, DCS, UMTS
- WiMAX, Wibro, WLAN
- RF Sub-Systems



Package Type : CP-16A

## Description

RFHIC's LOW Noise Amplifier series are all hybrid LNA type products which includes all matching for the convenience of customers. CL series are focused on giving lowest noise possible. The structure of the device is built with GaAs p-HEMT die attached on a ceramic thick film substrate. The device is still smaller than the area one would use for the application notes all together. Depending on the part number, one can use this in different frequency applications. All LNA hybrids are possible to have custom frequency & spec without any additional NRE cost involved. All RFHIC products are RoHS compliant.

## Electrical Specifications

PARAMETER	UNIT	CL0902-L		CL1502-L	CL1802-L	CL2102-L
Frequency Range	MHz	824 ~ 894 (Cellular)	890 ~ 960 (GSM)	1400 ~ 1600	1700 ~ 2000	1850 ~ 2200
Small Signal Gain (S <sub>21</sub> )	dB	21	20	17	16	15
Gain Flatness	dB	±0.5	±0.5	±0.5	±0.5	±1.0
Input Return Loss (S <sub>11</sub> )	dB	-17	-17	-17	-18	-18
Output Return Loss (S <sub>22</sub> )	dB	-8.5	-8.5	-10	-10	-10
1dB Compression Point (P <sub>1dB</sub> )	dBm	20	20	21	21	20
Output 3 <sup>rd</sup> Order Intercept Point (OIP3) (TYP.)	dBm	31	31	33	33	33
Noise Figure (TYP.)	dB	0.7	0.7	0.6	0.6	0.6
DC Supply Current (V <sub>dc</sub> =+5V)	mA	100	100	90	100	100

### Test Condition

- ① Supply voltage = +5V, 50ohm System, Ta = 25 °C
- ② OIP3 is measured with two tones, at an output power of +0dBm/tone separated by 1MHz.

**Absolute Maximum Ratings**

PARAMETER	UNIT	RATING	REMARK
Device Voltage	V	8	-
RF Input Power	dBm	25	-
Operating Temperature	°C	-40 ~ 85	-
Storage Temperature	°C	-50 ~ 125	-

**Note**

Operation of this device in excess of any one of these parameters may cause permanent damage.

**Functional Diagram**

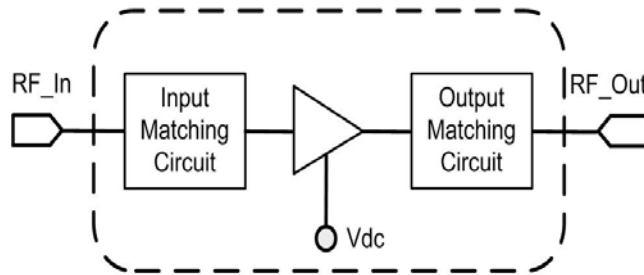

**Application Circuit**

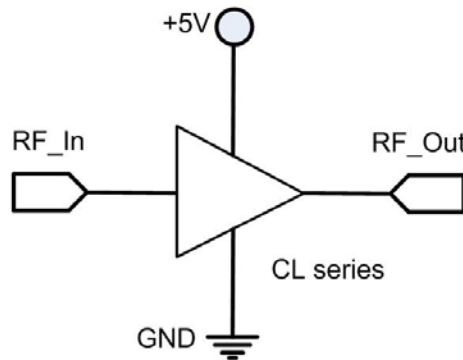

**ESD Protection**

Gallium Arsenide Integrated Circuits are sensitive to electrostatic discharge (ESD) and can be damaged by static electricity. Proper ESD control techniques should be used when handling these devices. Some of the precautions recommended are;

- Person at a workbench should be earthed via a wrist strap and a resistor.
- All mains-powered equipment should be connected to the mains via an earth-leakage switch.
- Equipment cases should be grounded.
- Relative humidity should be maintained between 40% and 50%.
- An ionizer is recommended.
- Keep static materials, such as plastic envelopes and plastic trays etc. away from the workbench.

Noise Figure

CL0902-L(Cellular)

Agilent 11:01:57 May 17, 2007

DUT Amplifier Sys Downconv Off			Frequency
Freq	NoiseFig dB	Gain dB	Freq Mode, Sweep
824.00000 MHz	0.711	20.577	Start Freq 824.000000 MHz
829.00000 MHz	0.712	20.577	
834.00000 MHz	0.696	20.510	Stop Freq 894.000000 MHz
839.00000 MHz	0.696	20.407	
844.00000 MHz	0.613	20.300	Center Freq 859.000000 MHz
849.00000 MHz	0.705	20.089	
854.00000 MHz	0.646	19.938	Freq Span 70.0000000 MHz
859.00000 MHz	0.583	19.795	
864.00000 MHz	0.621	19.645	Fixed Freq 1.50500000 GHz
869.00000 MHz	0.745	19.495	
874.00000 MHz	0.711	19.470	
879.00000 MHz	0.635	19.503	
884.00000 MHz	0.658	19.510	
889.00000 MHz	0.658	19.512	
894.00000 MHz	0.612	19.435	

Start 824.00 MHz BW 4 MHz Points 15 Stop 894.00 MHz  
Tcold 382.90 K Avgs Off Att 0 dB Loss Off Corr

More 1 of 2

CL0902-L(GSM)

Agilent 11:01:14 May 17, 2007

DUT Amplifier Sys Downconv Off			Frequency
Freq	NoiseFig dB	Gain dB	Freq Mode, Sweep
890.00000 MHz	0.642	19.532	Start Freq 890.000000 MHz
895.00000 MHz	0.633	19.566	
900.00000 MHz	0.671	19.559	Stop Freq 960.000000 MHz
905.00000 MHz	0.658	19.499	
910.00000 MHz	0.584	19.460	Center Freq 925.000000 MHz
915.00000 MHz	0.642	19.342	
920.00000 MHz	0.673	19.221	Freq Span 70.0000000 MHz
925.00000 MHz	0.569	19.149	
930.00000 MHz	0.582	19.055	Fixed Freq 1.50500000 GHz
935.00000 MHz	0.618	18.898	
940.00000 MHz	0.600	18.817	
945.00000 MHz	0.593	18.816	
950.00000 MHz	0.616	18.800	
955.00000 MHz	0.538	18.862	
960.00000 MHz	0.599	18.874	

Start 890.00 MHz BW 4 MHz Points 15 Stop 960.00 MHz  
Tcold 382.73 K Avgs Off Att 0 dB Loss Off Corr

More 1 of 2

CL1502-L

Agilent 09:19:19 May 22, 2007

DUT Amplifier Sys Downconv Off			Frequency
Freq	NoiseFig dB	Gain dB	Freq Mode, Sweep
1.400000 GHz	0.586	17.762	Start Freq 1.40000000 GHz
1.414286 GHz	0.586	18.017	
1.428571 GHz	0.578	17.422	Stop Freq 1.60000000 GHz
1.442857 GHz	0.657	16.726	
1.457143 GHz	0.604	16.960	Center Freq 1.50000000 GHz
1.471429 GHz	0.539	17.627	
1.485714 GHz	0.570	17.234	Freq Span 200.000000 MHz
1.500000 GHz	0.577	16.576	
1.514286 GHz	0.513	16.550	Fixed Freq 1.50500000 GHz
1.528571 GHz	0.587	16.938	
1.542857 GHz	0.534	16.704	
1.557143 GHz	0.551	16.265	
1.571429 GHz	0.505	16.391	
1.585714 GHz	0.496	16.787	
1.600000 GHz	0.504	16.488	

Start 1.40000 GHz BW 4 MHz Points 15 Stop 1.60000 GHz  
Tcold 382.90 K Avgs Off Att 0 dB Loss Off Corr

More 1 of 2

CL1802-L

Agilent 09:24:27 May 22, 2007

DUT Amplifier Sys Downconv Off			Frequency
Freq	NoiseFig dB	Gain dB	Freq Mode, Sweep
1.750000 GHz	0.578	15.278	Start Freq 1.75000000 GHz
1.758571 GHz	0.643	15.438	
1.767143 GHz	0.621	15.563	Stop Freq 1.87000000 GHz
1.775714 GHz	0.575	15.485	
1.784286 GHz	0.610	15.206	Center Freq 1.81000000 GHz
1.792857 GHz	0.626	15.053	
1.801429 GHz	0.606	15.026	Freq Span 120.000000 MHz
1.810000 GHz	0.554	15.128	
1.818571 GHz	0.600	15.147	Fixed Freq 1.50500000 GHz
1.827143 GHz	0.609	15.090	
1.835714 GHz	0.582	14.800	
1.844286 GHz	0.616	14.607	
1.852857 GHz	0.613	14.488	
1.861429 GHz	0.602	14.569	
1.870000 GHz	0.599	14.816	

Start 1.75000 GHz BW 4 MHz Points 15 Stop 1.87000 GHz  
Tcold 383.15 K Avgs Off Att 0 dB Loss Off Corr

More 1 of 2

CL2102-L

Agilent 09:31:14 May 22, 2007

DUT Amplifier Sys Downconv Off			Frequency
Freq	NoiseFig dB	Gain dB	Freq Mode, Sweep
1.920000 GHz	0.508	14.575	Start Freq 1.92000000 GHz
1.937857 GHz	0.557	14.656	
1.955714 GHz	0.589	14.467	Stop Freq 2.17000000 GHz
1.973571 GHz	0.500	14.457	
1.991429 GHz	0.572	14.424	Center Freq 2.04500000 GHz
2.009286 GHz	0.602	14.225	
2.027143 GHz	0.624	13.973	Freq Span 250.000000 MHz
2.045000 GHz	0.536	14.151	
2.062857 GHz	0.577	13.949	Fixed Freq 1.50500000 GHz
2.080714 GHz	0.578	13.706	
2.098571 GHz	0.653	13.715	
2.116429 GHz	0.646	13.812	
2.134286 GHz	0.531	13.565	
2.152143 GHz	0.617	13.396	
2.170000 GHz	0.590	13.595	

Start 1.92000 GHz BW 4 MHz Points 15 Stop 2.17000 GHz  
Tcold 383.52 K Avgs Off Att 0 dB Loss Off Corr

More 1 of 2

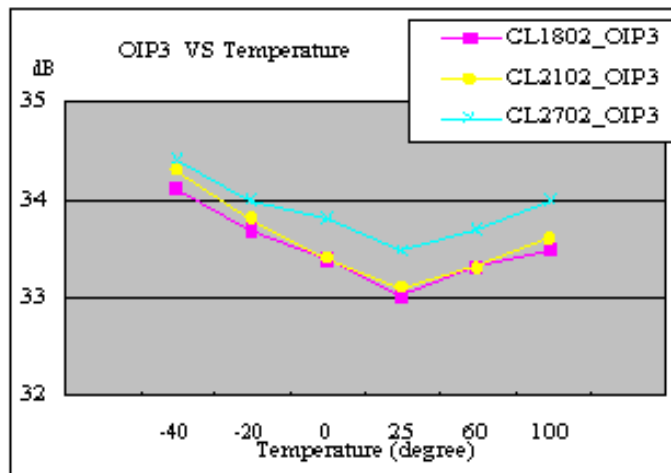
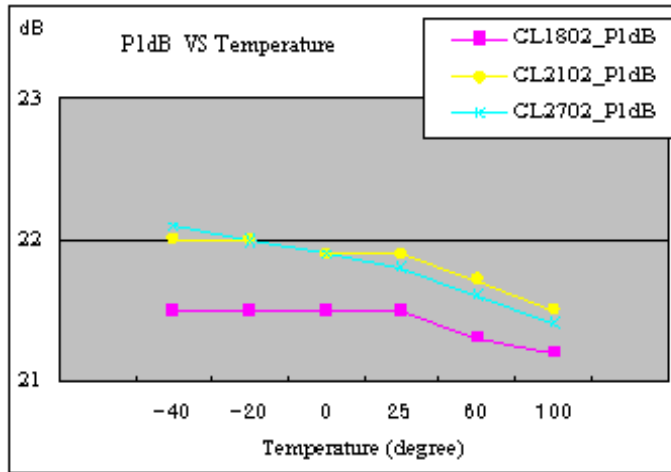
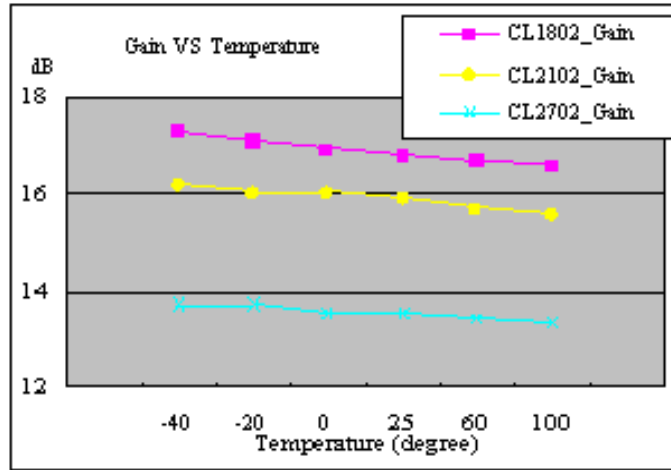

Package Dimensions (Type: CP-16A)

\* Unit: mm[inch] | Tolerance ±0.15[.006]

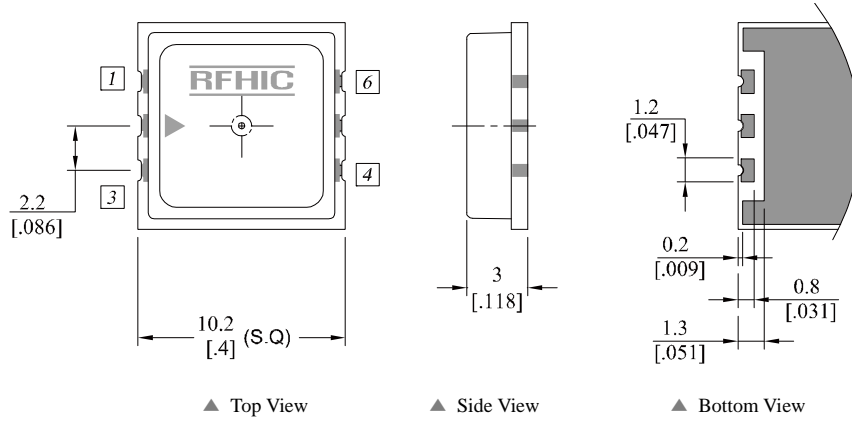

Pin Description			
Pin No	Function	Pin No	Function
1	GND	4	GND
2	Input	5	Output
3	GND	6	Vcc

Recommended Pattern

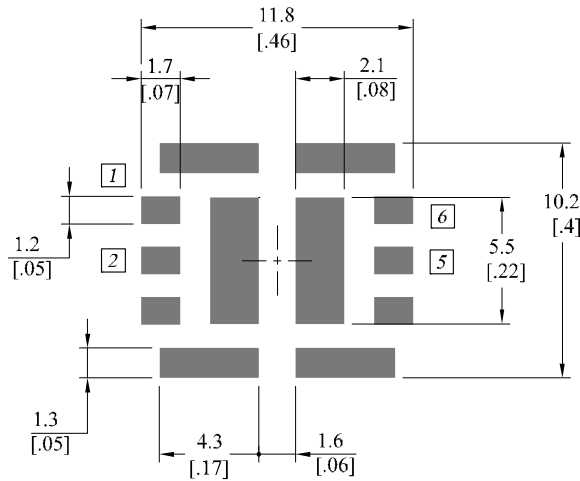

Recommended Mounting Configuration

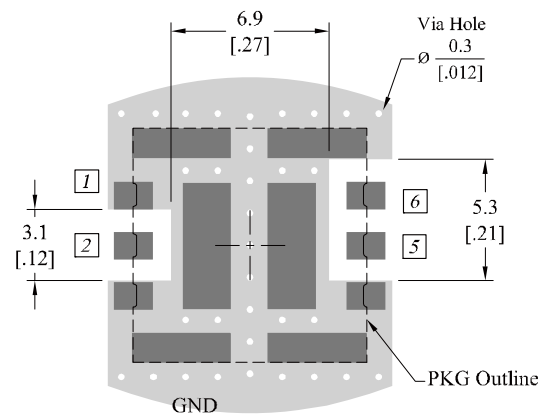

\* Mounting Configuration Notes

1. Ground / thermal via holes are critical for the proper performance of this device.
2. Add as much copper as possible to inner and outer layers near the part to ensure optimal thermal performance.
3. Mounting screws can be added near the part to fasten the board to a heatsink. Ensure that the ground / thermal via hole region contacts the heatsink.
4. Do not put solder mask on the backside of the PCB in the region where the board contacts the heatsink.
5. RF trace width depends upon the PCB material and construction.
6. Use 1 oz. Copper minimum.

**Revision History**

Part Number	Release Date	Version	Modification	Data Sheet Status
CL0902-L CL1502-L CL1802-L CL2102-L	2012.10.19	6.3	New datasheet format	-
CL0902-L CL1502-L CL1802-L CL2102-L	2012.2.18	6.2	-	-

RFHIC Corporation reserves the right to make changes to any products herein or to discontinue any product at any time without notice. While product specifications have been thoroughly examined for reliability, RFHIC Corporation strongly recommends buyers to verify that the information they are using is accurate before ordering. RFHIC Corporation does not assume any liability for the suitability of its products for any particular purpose, and disclaims any and all liability, including without limitation consequential or incidental damages. RFHIC products are not intended for use in life support equipment or application where malfunction of the product can be expected to result in personal injury or death. Buyer uses or sells such products for any such unintended or unauthorized application, buyer shall indemnify, protect and hold RFHIC Corporation and its directors, officers, stockholders, employees, representatives and distributors harmless against any and all claims arising out of such unauthorized use.

Sales, inquiries and support should be directed to the local authorized geographic distributor for RFHIC Corporation. For customers in the US, please contact the US Sales Team at 919-677-8780. For all other inquiries, please contact the International Sales Team at 82-31-250-5078.