

10. Schematic Diagrams

10-1 MAIN(1/3)

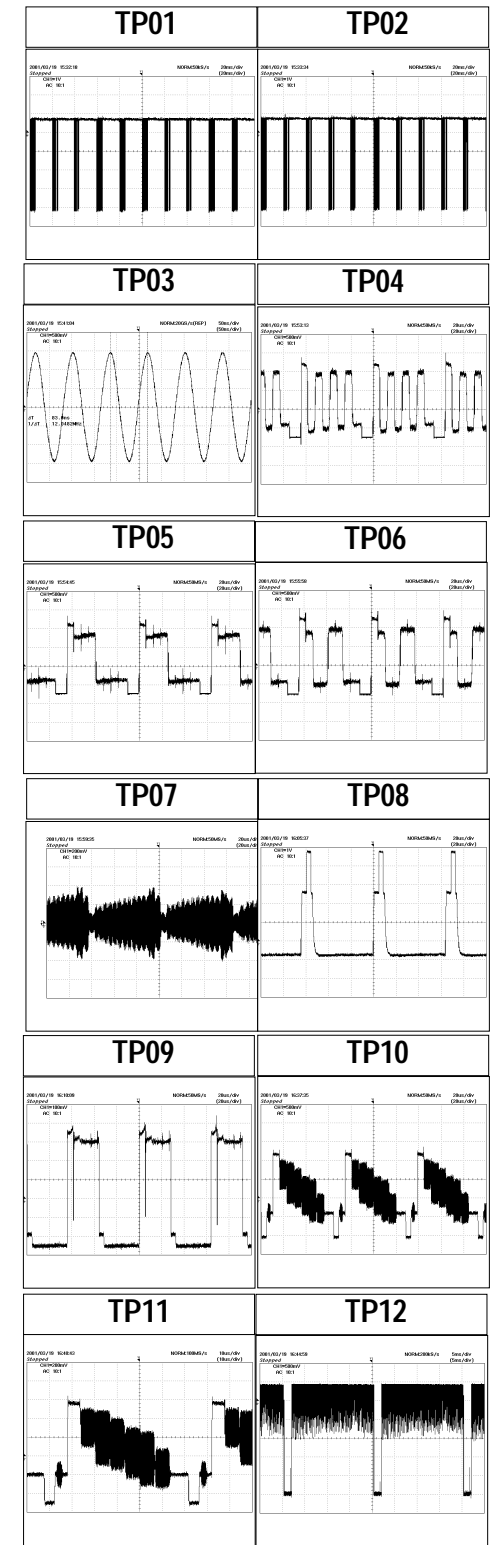

10-2 MAIN(2/3)

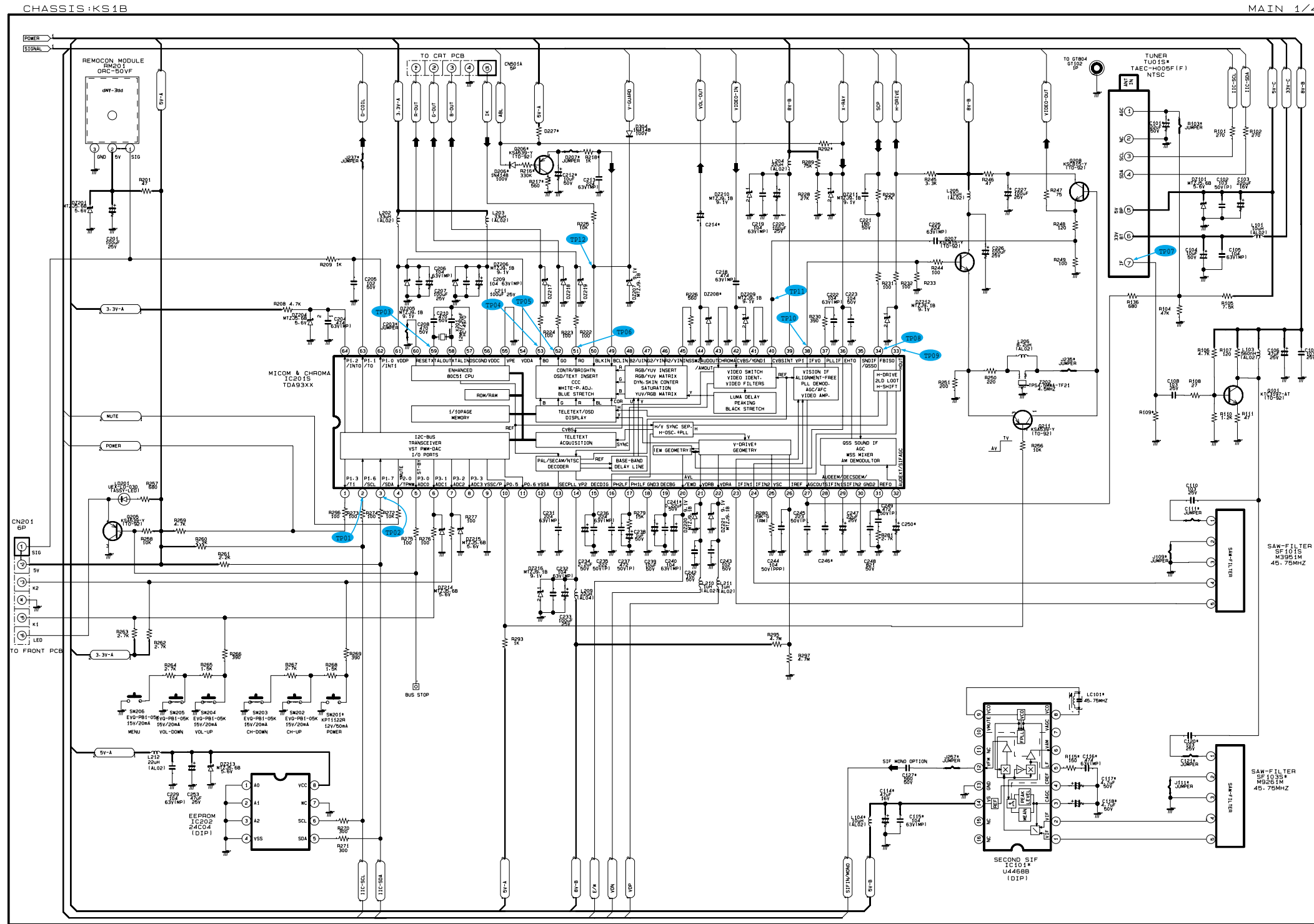
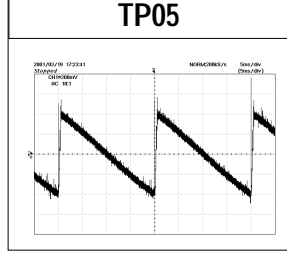
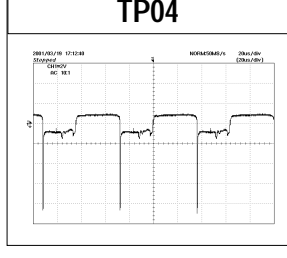
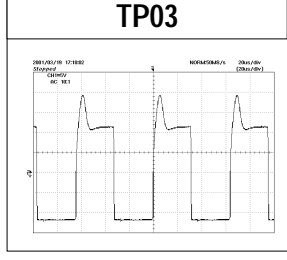
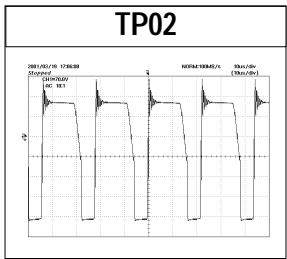
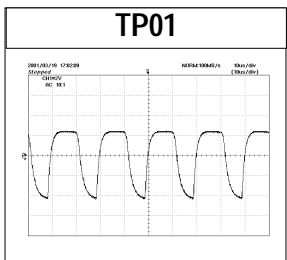
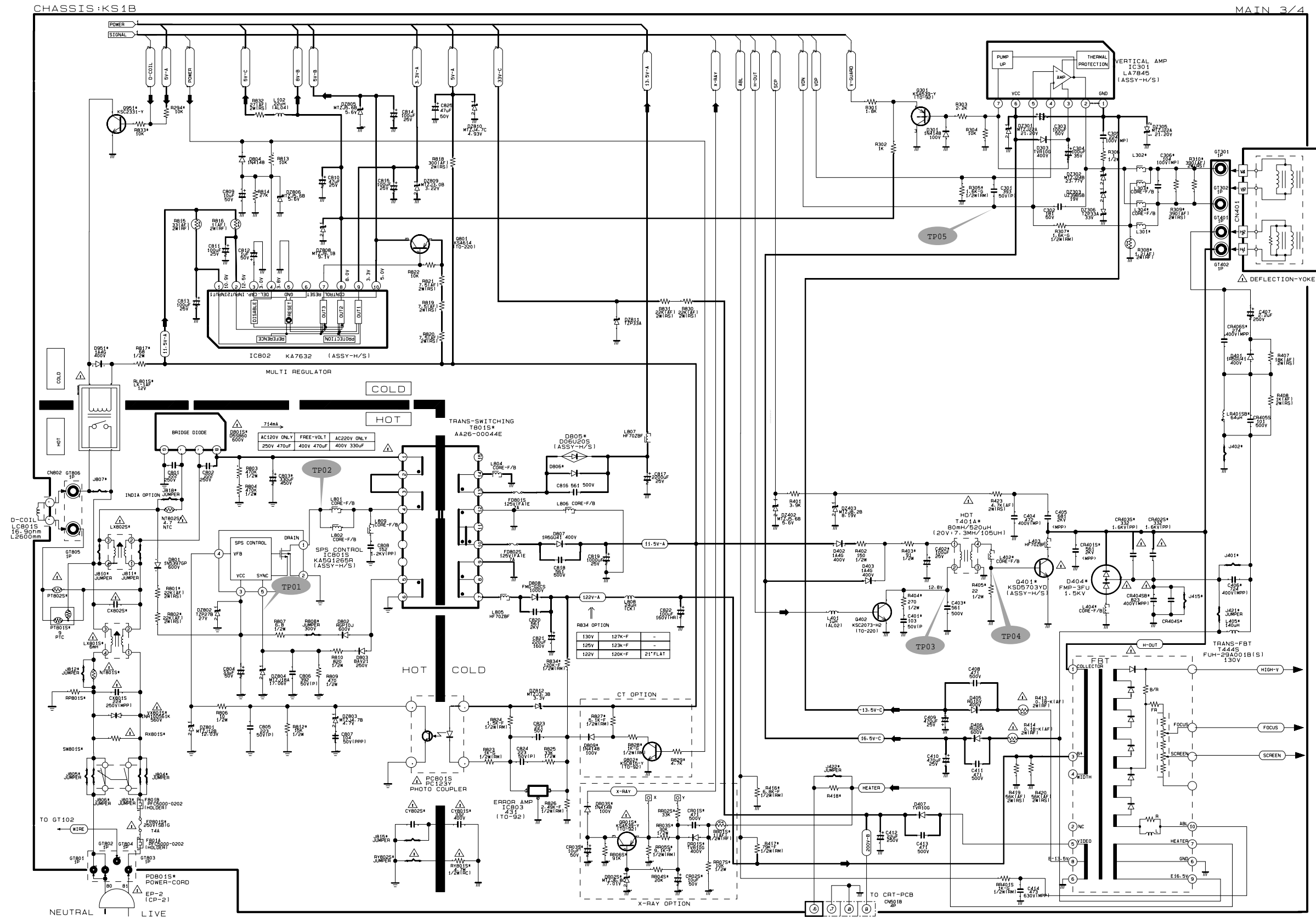

10-3 MAIN(3/3)

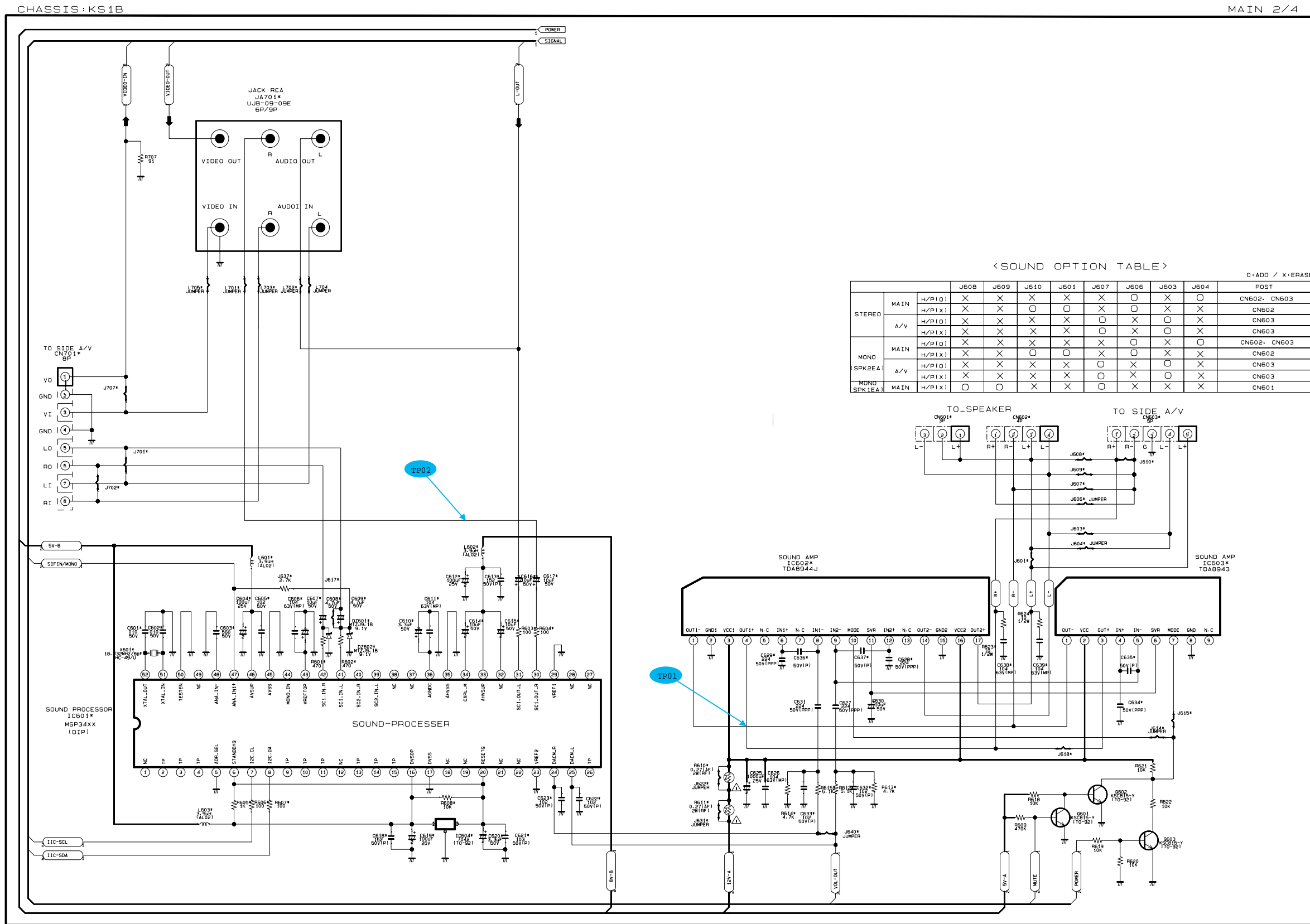

<SOUND OPTION TABLE>

		J60B	J609	J610	J601	J607	J606	J603	J604	POST
STEREO	MAIN	H/P(O)	X	X	X	X	O	X	O	CN602- CN603
	H/P(X)	X	X	O	O	X	X	X	X	CN602
A/V	H/P(O)	X	X	X	X	O	X	O	X	CN603
	H/P(X)	X	X	X	X	O	X	O	X	CN603
MONO	MAIN	H/P(O)	X	X	X	X	O	X	O	CN602- CN603
	H/P(X)	X	X	O	O	X	X	X	X	CN602
SPK2EA	H/P(O)	X	X	X	X	O	X	O	X	CN603
	H/P(X)	X	X	X	X	O	X	O	X	CN603
MONO	MAIN	H/P(X)	O	O	X	X	O	X	X	CN601

O: ADD / X: ERASE

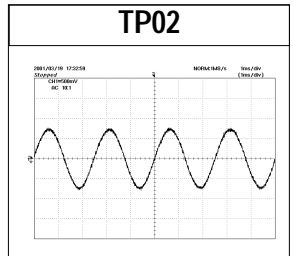
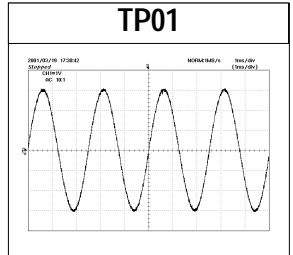

Power Line : Red
Signal Line : Blue

10-4 CRT, SIDE A/V

CHASSIS : KS1B

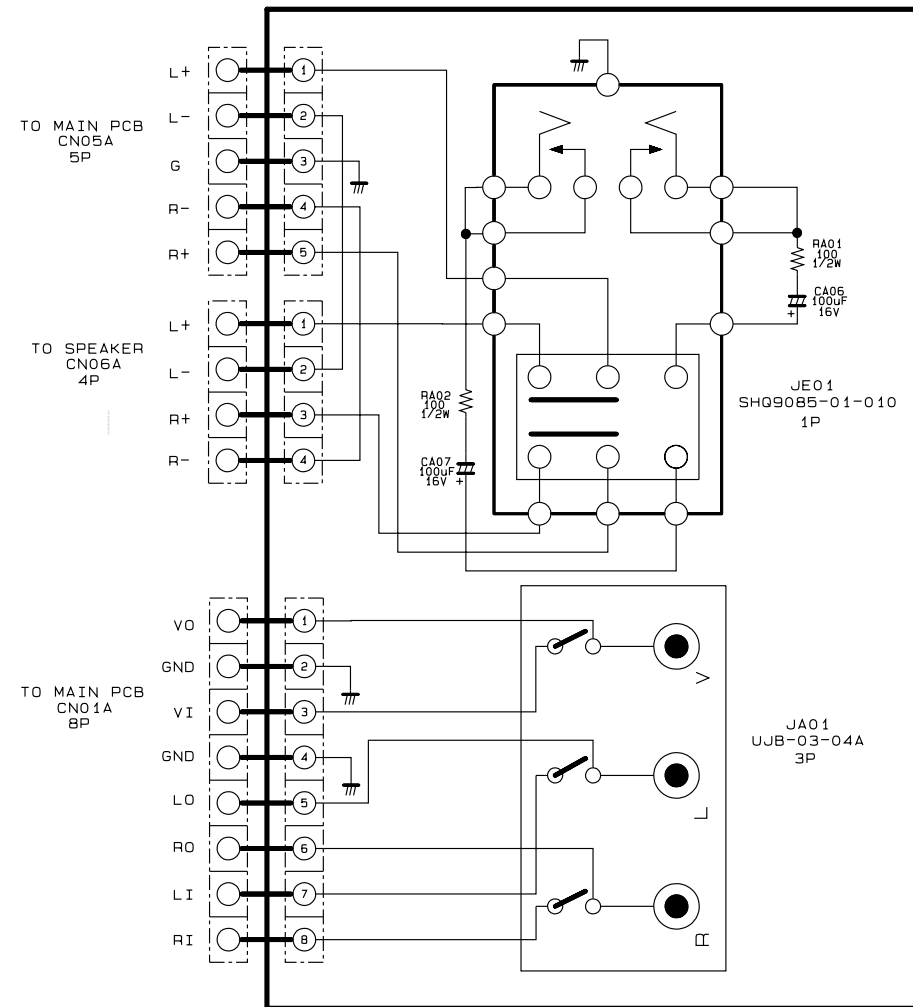
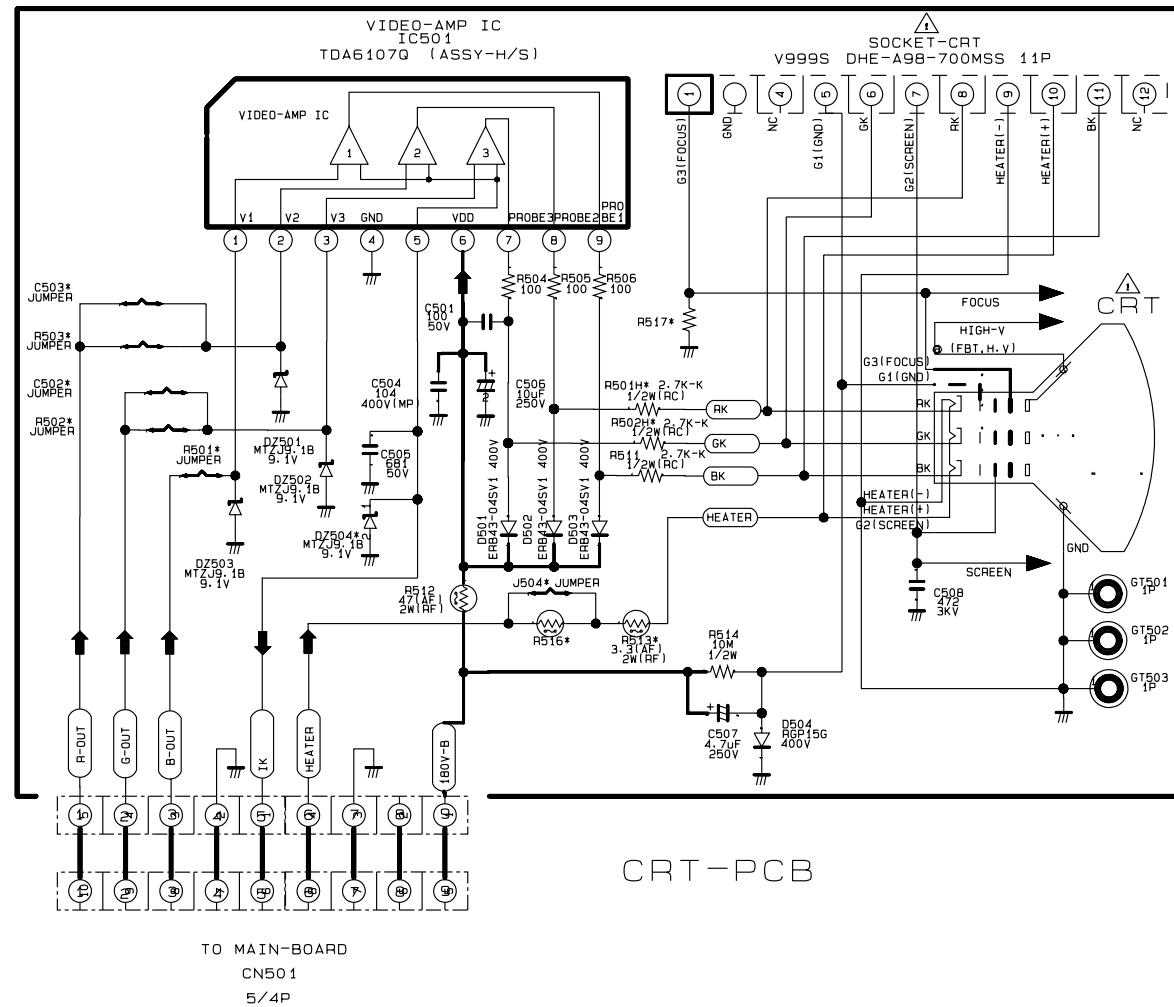

<SIDE A/V OPTION>

ASSY CODE	REMARK
AA95-00738A	21K3W