

High Efficiency Thyristor

$$V_{RRM} = 1200\text{ V}$$

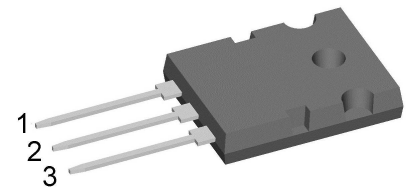
$$I_{TAV} = 100\text{ A}$$

$$V_T = 1.34\text{ V}$$

Single Thyristor

Part number

CLA100E1200KB



Backside: anode



Features / Advantages:

- Thyristor for line frequency
- Planar passivated chip
- Long-term stability

Applications:

- Line rectifying 50/60 Hz
- Softstart AC motor control
- DC Motor control
- Power converter
- AC power control
- Lighting and temperature control

Package: TO-264

- Industry standard outline
- RoHS compliant
- Epoxy meets UL 94V-0

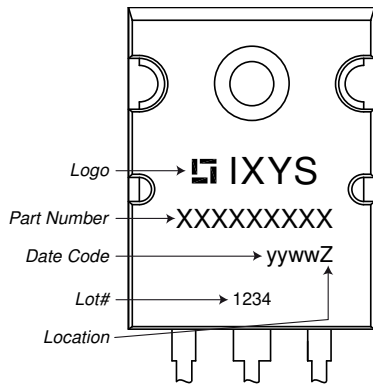
Disclaimer Notice

Information furnished is believed to be accurate and reliable. However, users should independently evaluate the suitability of and test each product selected for their own applications. Littelfuse products are not designed for, and may not be used in, all applications. Read complete Disclaimer Notice at www.littelfuse.com/disclaimer-electronics.

Thyristor			Ratings			
Symbol	Definition	Conditions	min.	typ.	max.	Unit
$V_{RSM/DSM}$	max. non-repetitive reverse/forward blocking voltage	$T_{VJ} = 25^{\circ}\text{C}$			1300	V
$V_{RRM/DRM}$	max. repetitive reverse/forward blocking voltage	$T_{VJ} = 25^{\circ}\text{C}$			1200	V
I_{RD}	reverse current, drain current	$V_{R/D} = 1200\text{ V}$	$T_{VJ} = 25^{\circ}\text{C}$		10	μA
		$V_{R/D} = 1200\text{ V}$	$T_{VJ} = 125^{\circ}\text{C}$		5	mA
V_T	forward voltage drop	$I_T = 100\text{ A}$	$T_{VJ} = 25^{\circ}\text{C}$		1.37	V
		$I_T = 200\text{ A}$			1.78	V
		$I_T = 100\text{ A}$	$T_{VJ} = 125^{\circ}\text{C}$		1.34	V
		$I_T = 200\text{ A}$			1.85	V
I_{TAV}	average forward current	$T_C = 105^{\circ}\text{C}$	$T_{VJ} = 150^{\circ}\text{C}$		100	A
$I_{T(RMS)}$	RMS forward current	180° sine			160	A
V_{T0}	threshold voltage	} for power loss calculation only	$T_{VJ} = 150^{\circ}\text{C}$		0.82	V
r_T	slope resistance				5.2	m Ω
R_{thJC}	thermal resistance junction to case				0.2	K/W
R_{thCH}	thermal resistance case to heatsink			0.15		K/W
P_{tot}	total power dissipation		$T_C = 25^{\circ}\text{C}$		625	W
I_{TSM}	max. forward surge current	$t = 10\text{ ms}; (50\text{ Hz}), \text{ sine}$	$T_{VJ} = 45^{\circ}\text{C}$		1.10	kA
		$t = 8,3\text{ ms}; (60\text{ Hz}), \text{ sine}$	$V_R = 0\text{ V}$		1.19	kA
		$t = 10\text{ ms}; (50\text{ Hz}), \text{ sine}$	$T_{VJ} = 150^{\circ}\text{C}$		935	A
		$t = 8,3\text{ ms}; (60\text{ Hz}), \text{ sine}$	$V_R = 0\text{ V}$		1.01	kA
I^2t	value for fusing	$t = 10\text{ ms}; (50\text{ Hz}), \text{ sine}$	$T_{VJ} = 45^{\circ}\text{C}$		6.05	kA ² s
		$t = 8,3\text{ ms}; (60\text{ Hz}), \text{ sine}$	$V_R = 0\text{ V}$		5.89	kA ² s
		$t = 10\text{ ms}; (50\text{ Hz}), \text{ sine}$	$T_{VJ} = 150^{\circ}\text{C}$		4.37	kA ² s
		$t = 8,3\text{ ms}; (60\text{ Hz}), \text{ sine}$	$V_R = 0\text{ V}$		4.25	kA ² s
C_J	junction capacitance	$V_R = 400\text{ V } f = 1\text{ MHz}$	$T_{VJ} = 25^{\circ}\text{C}$		43	pF
P_{GM}	max. gate power dissipation	$t_p = 30\text{ }\mu\text{s}$	$T_C = 150^{\circ}\text{C}$		10	W
		$t_p = 300\text{ }\mu\text{s}$			1	W
P_{GAV}	average gate power dissipation				0.5	W
$(di/dt)_{cr}$	critical rate of rise of current	$T_{VJ} = 150^{\circ}\text{C}; f = 50\text{ Hz}$ repetitive, $I_T = 300\text{ A}$			150	A/ μs
		$t_p = 200\text{ }\mu\text{s}; di_G/dt = 0.45\text{ A}/\mu\text{s};$ $I_G = 0.45\text{ A}; V = \frac{2}{3} V_{DRM}$ non-repet., $I_T = 100\text{ A}$			500	A/ μs
$(dv/dt)_{cr}$	critical rate of rise of voltage	$V = \frac{2}{3} V_{DRM}$ $R_{GK} = \infty$; method 1 (linear voltage rise)	$T_{VJ} = 150^{\circ}\text{C}$		1000	V/ μs
V_{GT}	gate trigger voltage	$V_D = 6\text{ V}$	$T_{VJ} = 25^{\circ}\text{C}$		1.5	V
			$T_{VJ} = -40^{\circ}\text{C}$		1.6	V
I_{GT}	gate trigger current	$V_D = 6\text{ V}$	$T_{VJ} = 25^{\circ}\text{C}$		40	mA
			$T_{VJ} = -40^{\circ}\text{C}$		80	mA
V_{GD}	gate non-trigger voltage	$V_D = \frac{2}{3} V_{DRM}$	$T_{VJ} = 150^{\circ}\text{C}$		0.2	V
I_{GD}	gate non-trigger current				5	mA
I_L	latching current	$t_p = 10\text{ }\mu\text{s}$	$T_{VJ} = 25^{\circ}\text{C}$		150	mA
		$I_G = 0.45\text{ A}; di_G/dt = 0.45\text{ A}/\mu\text{s}$				
I_H	holding current	$V_D = 6\text{ V } R_{GK} = \infty$	$T_{VJ} = 25^{\circ}\text{C}$		100	mA
t_{gd}	gate controlled delay time	$V_D = \frac{1}{2} V_{DRM}$	$T_{VJ} = 25^{\circ}\text{C}$		2	μs
		$I_G = 0.5\text{ A}; di_G/dt = 0.5\text{ A}/\mu\text{s}$				
t_q	turn-off time	$V_R = 100\text{ V}; I_T = 100\text{ A}; V = \frac{2}{3} V_{DRM}$ $di/dt = 10\text{ A}/\mu\text{s } dv/dt = 20\text{ V}/\mu\text{s } t_p = 200\text{ }\mu\text{s}$	$T_{VJ} = 125^{\circ}\text{C}$		150	μs



Package TO-264			Ratings			
Symbol	Definition	Conditions	min.	typ.	max.	Unit
I_{RMS}	RMS current	per terminal			70	A
T_{VJ}	virtual junction temperature		-40		150	°C
T_{op}	operation temperature		-40		125	°C
T_{stg}	storage temperature		-40		150	°C
Weight				10		g
M_D	mounting torque		0.8		1.2	Nm
F_C	mounting force with clip		20		120	N



Part description

- C = Thyristor (SCR)
- L = High Efficiency Thyristor
- A = (up to 1200V)
- 100 = Current Rating [A]
- E = Single Thyristor
- 1200 = Reverse Voltage [V]
- KB = TO-264 (3)

Ordering	Ordering Number	Marking on Product	Delivery Mode	Quantity	Code No.
Standard	CLA100E1200KB	CLA100E1200KB	Tube	25	514750

Similar Part	Package	Voltage class
CLA100E1200HB	TO-247AD (3)	1200

Equivalent Circuits for Simulation

* on die level

$T_{VJ} = 150^{\circ}C$

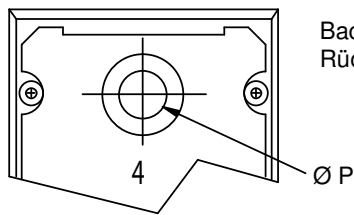
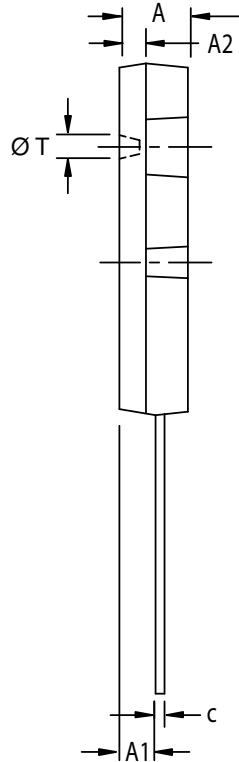
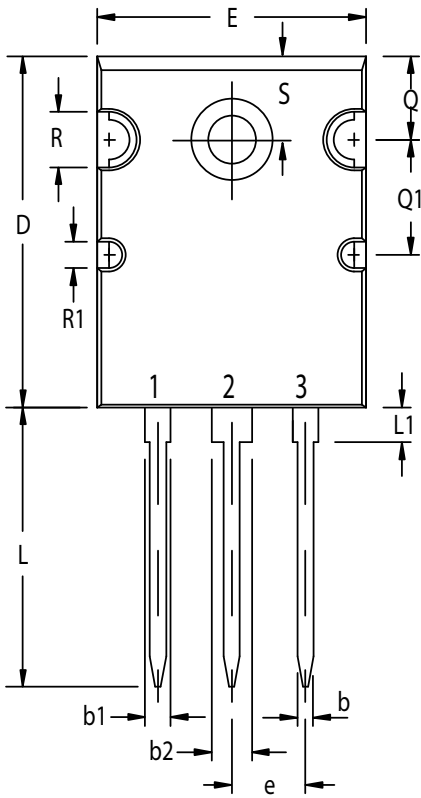


Thyristor

$V_{0 \max}$	threshold voltage	0.82	V
$R_{0 \max}$	slope resistance *	2.7	mΩ

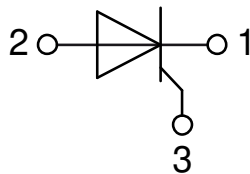


Outlines TO-264



Back side
Rückseite

SYM	INCHES		MILLIMETERS	
	MIN	MAX	MIN	MAX
A	0.190	0.202	4.82	5.13
A1	0.100	0.114	2.54	2.89
A2	0.079	0.083	2.00	2.10
b	0.044	0.056	1.12	1.42
b1	0.094	0.106	2.39	2.69
b2	0.114	0.122	2.90	3.09
c	0.021	0.033	0.53	0.83
D	1.020	1.030	25.91	26.16
E	0.780	0.786	19.81	19.96
e	5.46 BSC		.215 BSC	
J	0.000	0.010	0.00	0.25
K	0.000	0.010	0.00	0.25
L	0.800	0.820	20.32	20.83
L1	0.090	0.102	2.29	2.59
P	0.125	0.144	3.17	3.66
Q	0.239	0.247	6.07	6.27
Q1	0.330	0.342	8.38	8.69
R	0.150	0.170	3.81	4.32
R1	0.070	0.090	1.78	2.29
S	0.238	0.248	6.04	6.30
T	0.062	0.072	1.57	1.83



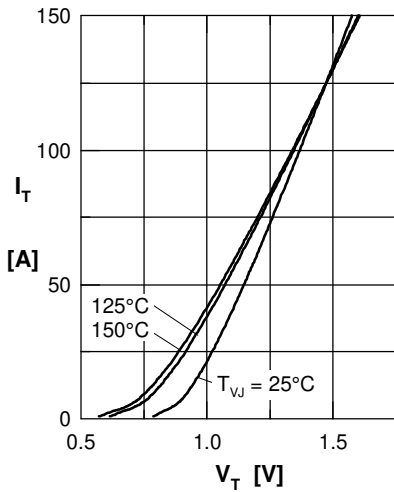
Thyristor


Fig. 1 Forward characteristics

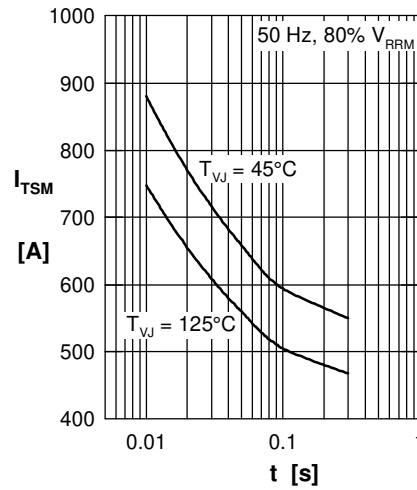


Fig. 2 Surge overload current

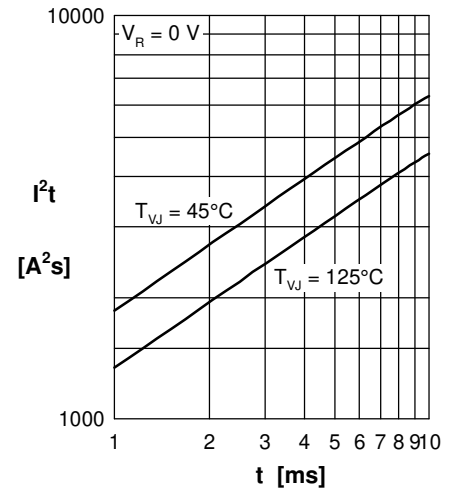
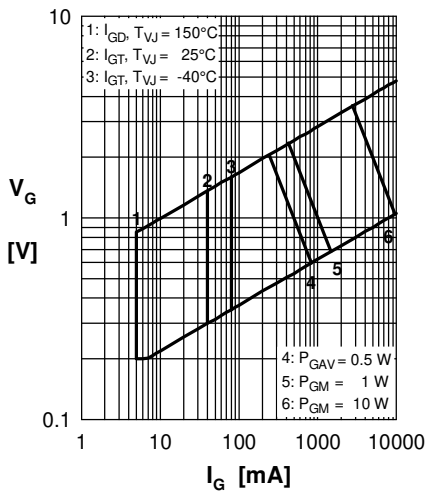

 Fig. 3 I^2t versus time (1-10 ms)


Fig. 4 Gate trigger characteristics

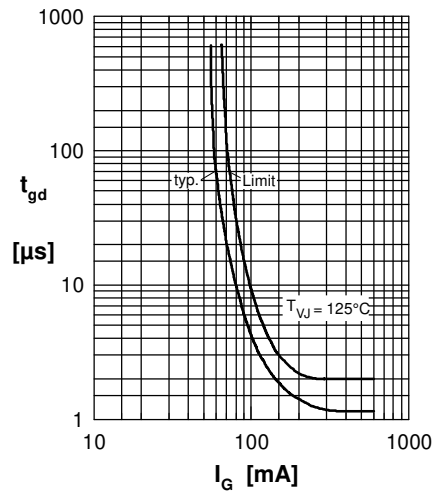


Fig. 5 Gate controlled delay time

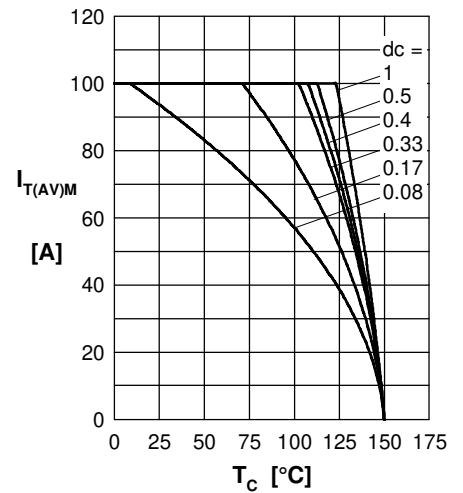


Fig. 6 Max. forward current at case temperature

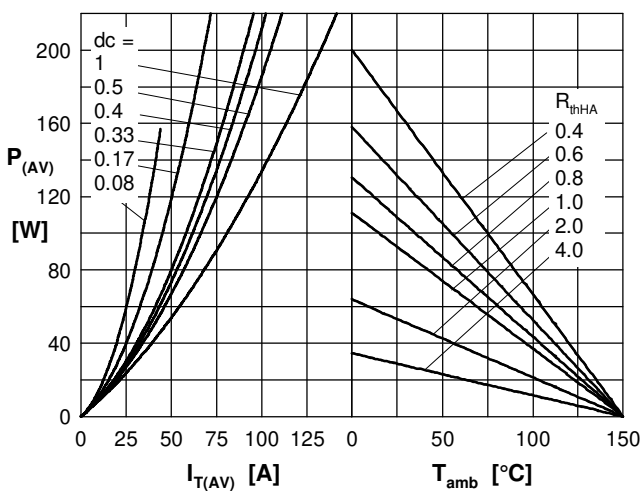
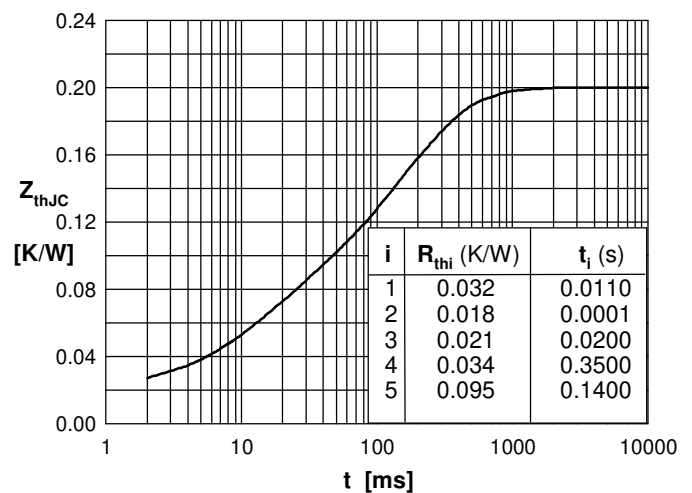

 Fig. 7a Power dissipation versus direct output current
 Fig. 7b and ambient temperature


Fig. 8 Transient thermal impedance