



Chunghwa Picture Tubes, Ltd. Product Specification

To :

Date :

TFT LCD

CLAA070NA01CT

ACCEPTED BY : (V0.3)

APPROVED BY	CHECKED BY	PREPARED BY

Prepared by :

Product Planning Management Division
Small & Medium TFT Product Business Unit
CHUNGHWA PICTURE TUBES, LTD.

1127 Hopin Rd., Padeh, Taoyuan, Taiwan 334, R.O.C.
TEL: +886-3-3675151 FAX: +886-3-377-3858

Doc.No:	SPEC_CLAA070NA01CT_V0.3_	_070830	Issue Date:	2007/05/28
---------	--------------------------	---------	-------------	------------

5. INPUT SIGNAL(DE ONLY MODE)

5.1 Timing Specification

Item		Symbol	Min	Typ	Max	Unit	
LVDS input signal sequence	CLK Frequency		fCLKin	39	45	52	MHz
LCD input signal sequence (Input LVDS Transmitter)	Horizontal	Horizontal total Time	t _H	1150	1200	1250	tCLK
		Horizontal effective Time	t _{HA}	1024			tCLK
		Horizontal Blank Time	t _{HB}	126	176	226	tCLK
	Vertical	Frame	fV	55	60	65	Hz
		Vertical total Time	t _V	610	625	640	t _H
		Vertical effectiveTime	t _{VA}	600			t _H
		Vertical Blank Time	t _{VB}	10	25	50	t _H

Studio Technology Co., Ltd.

5.2 Timing sequence(Timing chart)

5.2.1 Horizontal Timing Sequence

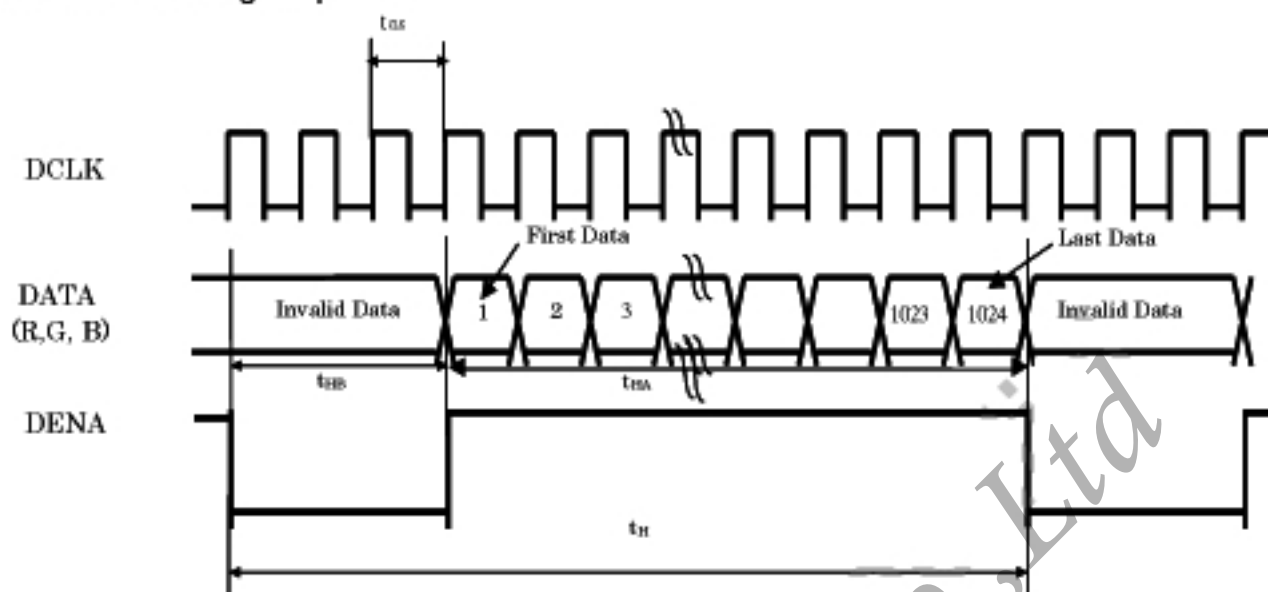

5.2.2 Vertical Timing Sequence

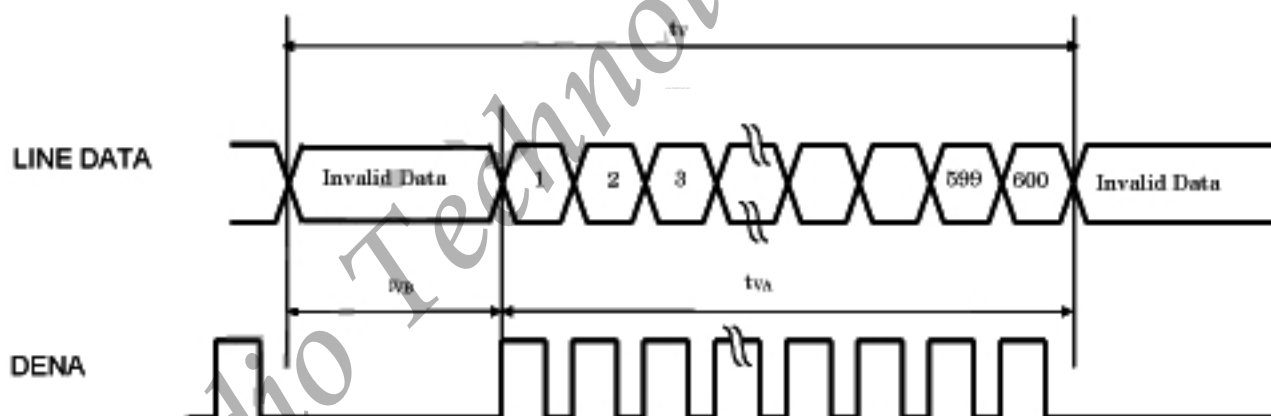

5.3 LVDS Input Data mapping

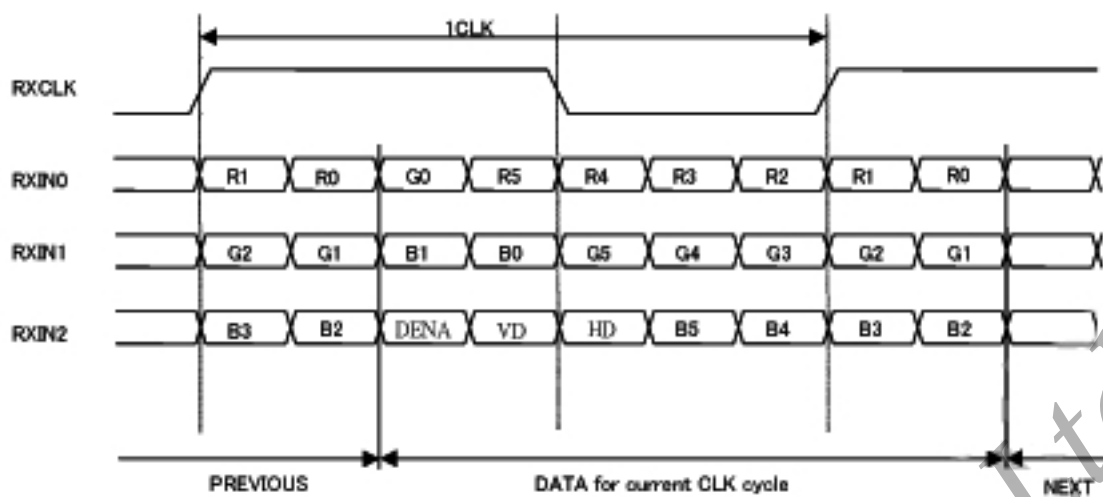

5.4 Color Data Assignment

COLOR	INPUT DATA	R DATA						G DATA						B DATA					
		R5	R4	R3	R2	R1	R0	G5	G4	G3	G2	G1	G0	B5	B4	B3	B2	B1	B0
		MSB					LSB	MSB					LSB	MSB					LSB
BASIC COLOR	BLACK	0	0	0	0	0	0	0	0	0	0	0	0	0	0	0	0	0	0
	RED(63)	1	1	1	1	1	1	0	0	0	0	0	0	0	0	0	0	0	0
	GREEN(63)	0	0	0	0	0	0	1	1	1	1	1	1	0	0	0	0	0	0
	BLUE(63)	0	0	0	0	0	0	0	0	0	0	0	0	1	1	1	1	1	1
	CYAN	0	0	0	0	0	0	1	1	1	1	1	1	1	1	1	1	1	1
	MAGENTA	1	1	1	1	1	1	0	0	0	0	0	0	1	1	1	1	1	1
	YELLOW	1	1	1	1	1	1	1	1	1	1	1	1	0	0	0	0	0	0
	WHITE	1	1	1	1	1	1	1	1	1	1	1	1	1	1	1	1	1	1
RED	RED(0)	0	0	0	0	0	0	0	0	0	0	0	0	0	0	0	0	0	0
	RED(1)	0	0	0	0	0	1	0	0	0	0	0	0	0	0	0	0	0	0
	RED(2)	0	0	0	0	1	0	0	0	0	0	0	0	0	0	0	0	0	0
	RED(62)	1	1	1	1	1	0	0	0	0	0	0	0	0	0	0	0	0	0
	RED(63)	1	1	1	1	1	1	0	0	0	0	0	0	0	0	0	0	0	0
GREEN	GREEN(0)	0	0	0	0	0	0	0	0	0	0	0	0	0	0	0	0	0	0
	GREEN(1)	0	0	0	0	0	0	0	0	0	0	0	1	0	0	0	0	0	0
	GREEN(2)	0	0	0	0	0	0	0	0	0	0	1	0	0	0	0	0	0	0
	GREEN(62)	0	0	0	0	0	0	1	1	1	1	1	0	0	0	0	0	0	0
	GREEN(63)	0	0	0	0	0	0	1	1	1	1	1	1	0	0	0	0	0	0
BLUE	BLUE(0)	0	0	0	0	0	0	0	0	0	0	0	0	0	0	0	0	0	0
	BLUE(1)	0	0	0	0	0	0	0	0	0	0	0	0	0	0	0	0	0	1
	BLUE(2)	0	0	0	0	0	0	0	0	0	0	0	0	0	0	0	0	1	0
	BLUE(62)	0	0	0	0	0	0	0	0	0	0	0	0	1	1	1	1	1	0
	BLUE(63)	0	0	0	0	0	0	0	0	0	0	0	0	1	1	1	1	1	1

Remarks :

(1) Definition of Gray Scale

color(n) : n is series of Gray Scale

The more n value is, the bright Gray Scale.

(2)Data:1-High,0-Low

6. CHARACTERISTIC OF TOUCH PANEL

6.1 Basis characteristic

Item	Standard	Note
Operating Voltage	5V(Typ)/7V(Max)	DC
Surface Treatment	Anti-Glare · Hardness : 3H	
Activation Force	Max. 100gf	with stylus pen (R 0.8mm) or finger (R 8.0mm)
Interface Type	4 Wire Resistive	
Resistance Between Terminals	X(Film side) : 200~900Ω Y(Glass side) : 200~900Ω	At the connector
Linearity	X(Film side) : ≤1.5% Y(Glass side) : ≤1.5%	Testing interval is 2mm with load 80g
Insulation Resistance	Min. 20MΩ	At DC 25V

6.2 Design guideline for Touch-Panel

- The Housing Cushion on touch-panel must be set at outside of T.P's view-area .
- The Cushion material must be elastic material.
- The housing must avoid to touch the T.P
- To combine, the housing should not be stuck on T.P.
- Example of housing design :

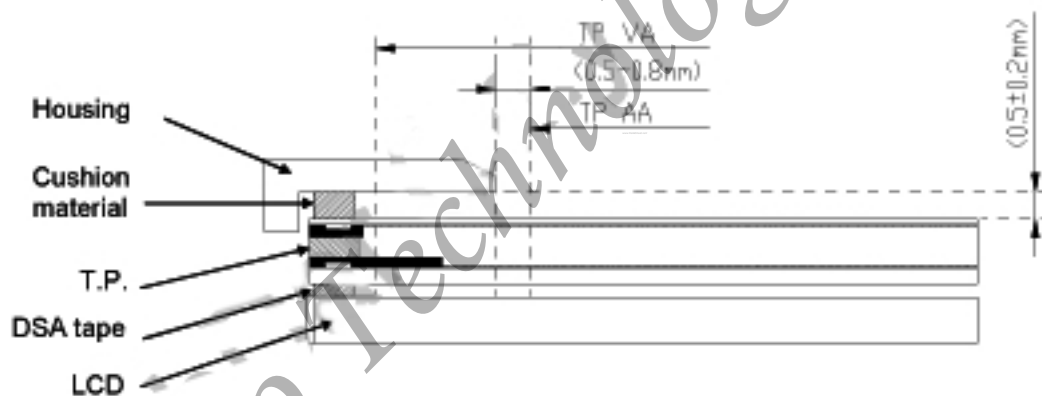

6.3 Circuit Diagram

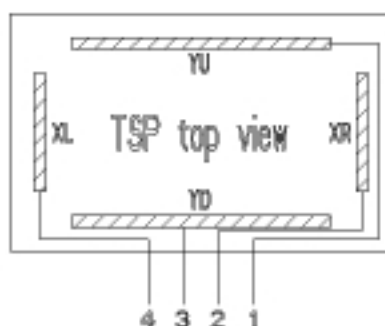

7. BLOCK DIAGRAM

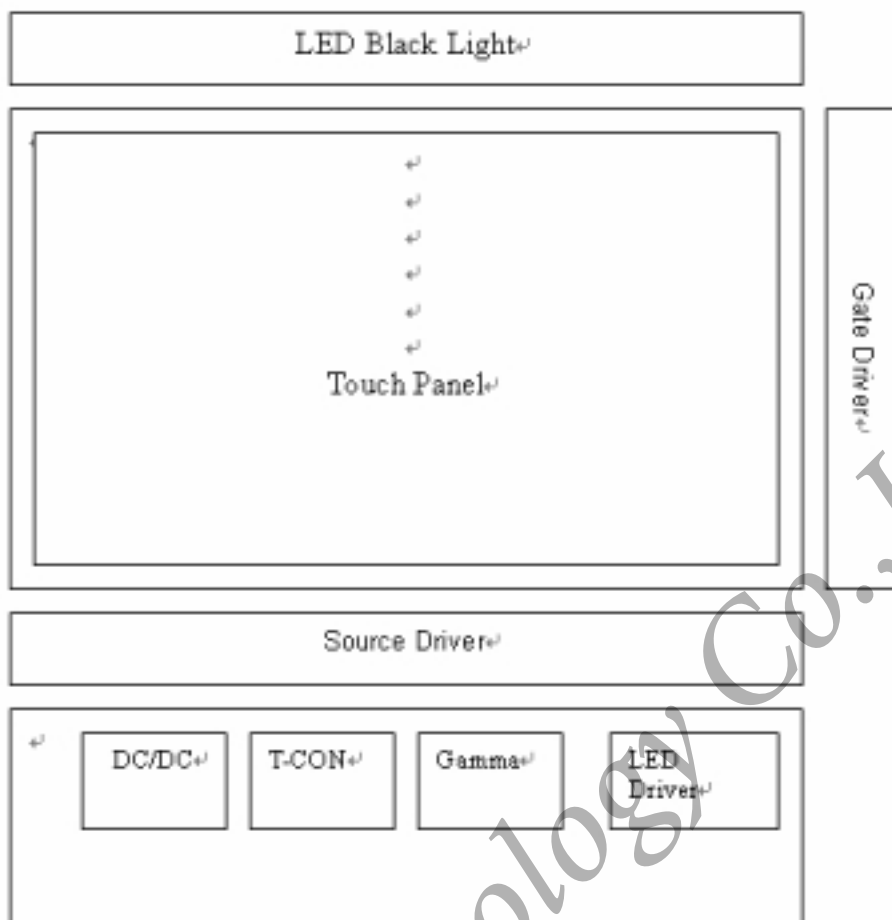

8. MECHANICAL DIMENSION

8.1 Front Side

[Unit : mm]

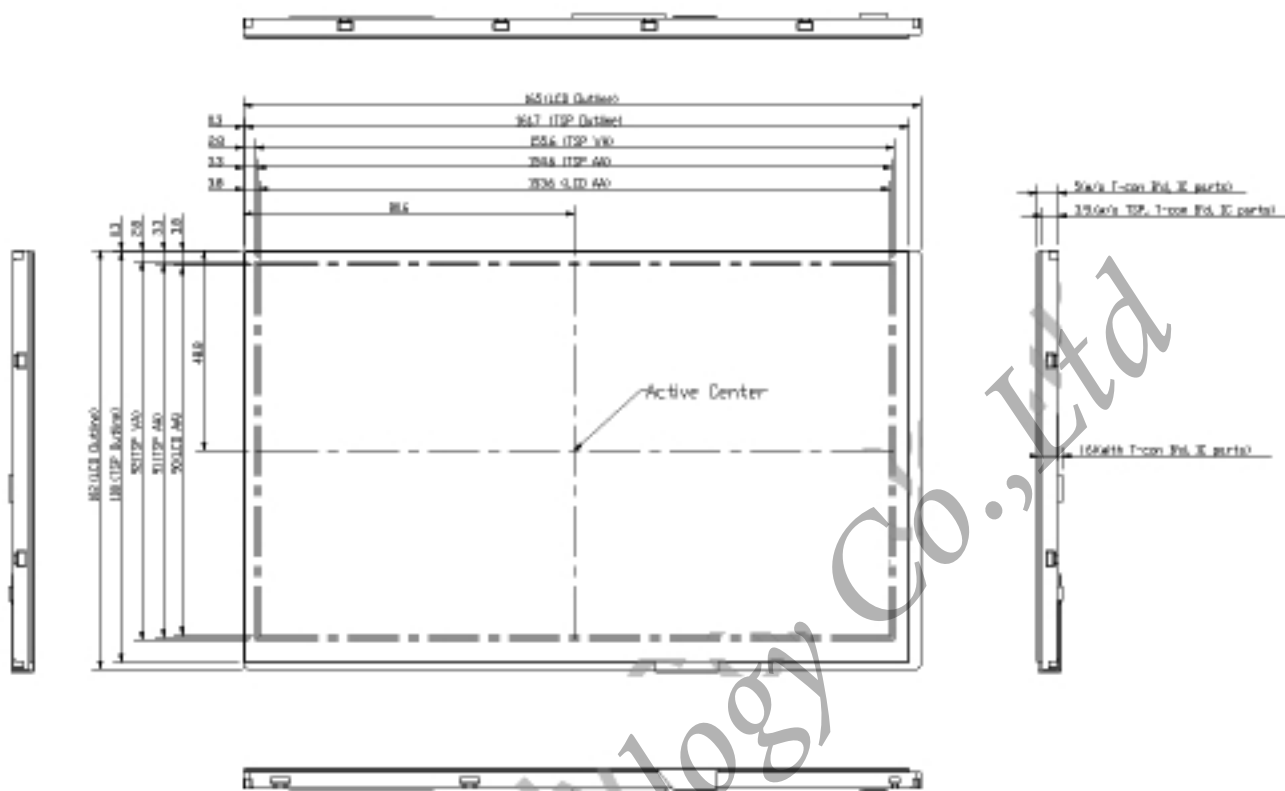

8.2 Rear Side

[Unit : mm]

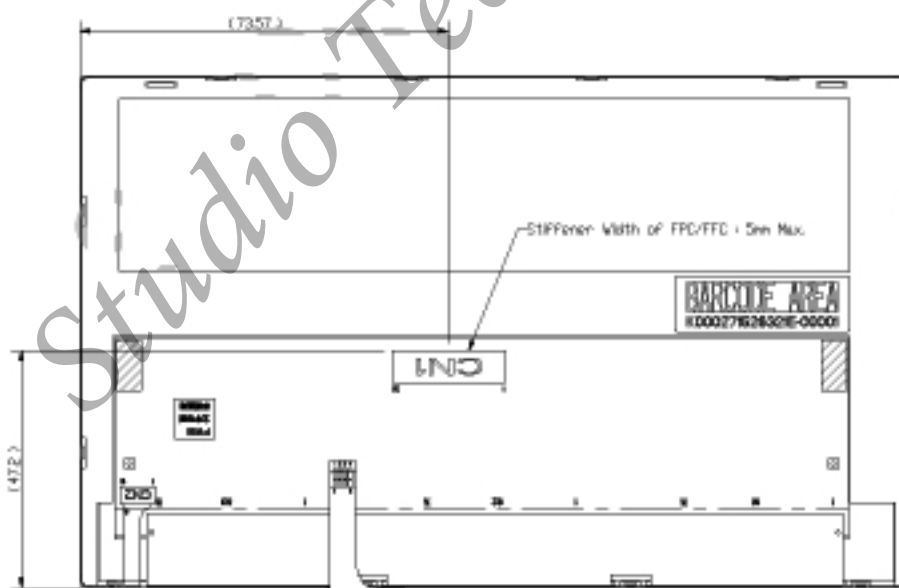

Note :

1. General tolerance : $\pm 0.3\text{mm}$
2. LCD connector CN1(30pin) : STARCONN · P/N : 089N30-000R00-G2

9. OPTICAL CHARACTERISTICS

ITEM		SYMBOL	CONDITION	MIN.	TYP.	MAX.	UNIT	Remarks
Contrast Ratio		CR	Point-5	300	400	--	--	*1)*2)*3)
Luminance*)		Lw	Point-5	200	250	--	cd/m ²	*1)*3)
Luminance Uniformity		ΔL		70	80	--	%	*1)*3)
Response Time (White - Black)		Tr+ Tf	Point-5	--	--	20	ms	*1)*3)*5)
Viewing Angle	Horizontal	ϕ	CR \geq 10 Point-5	120	140	--	°	*1)*2)*4)
	Vertical	θ		90	110	--	°	*1)*2)*4)
Color Coordinate	White	Wx Wy	Point-5	0.273 0.289	0.313 0.329	0.353 0.369	*1)*3)	*1)*3)
	Red	Rx Ry		0.544 0.299	0.584 0.339	0.624 0.379		
	Green	Gx Gy		0.275 0.528	0.315 0.568	0.355 0.608		
	Blue	Bx By		0.108 0.118	0.148 0.158	0.188 0.198		

Remarks :

*1) Measure condition : 25°C \pm 2°C · 60 \pm 10%RH · under 10 Lux in the dark room. BM-5A (TOPCON) · viewing angle 2° · VCC=3.3V · VLED=5V.

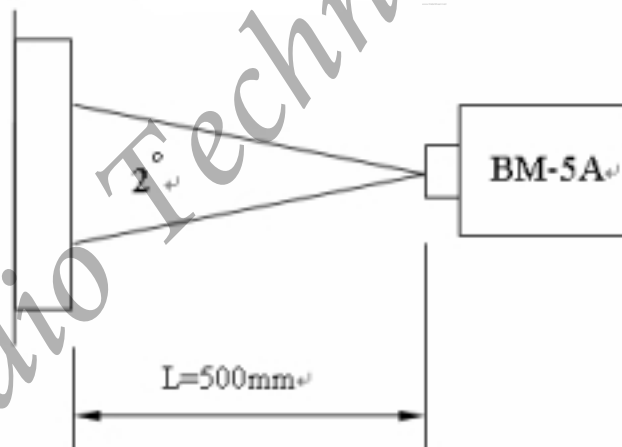

*2) Definition of contrast ratio :

Contrast Ratio (CR)= (White) Luminance of ON + (Black) Luminance of OFF

*3) Definition of luminance :

Measure white luminance on the point 5 as figure9-1

Definition of Luminance Uniformity:

Measure white luminance on the point1 ~9as figure9-1

$$\Delta L = [L(\text{MIN})/L(\text{MAX})] \times 100$$

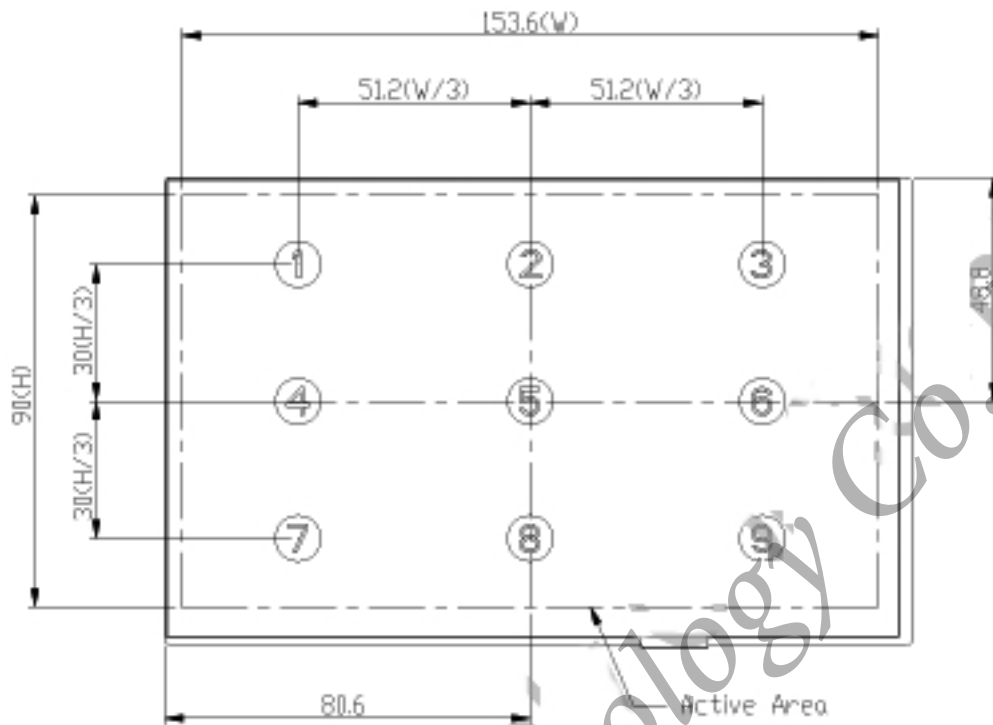

Fig9-1 Measuring point

*4) Definition of Viewing Angle(θ, ψ), refer to Fig9-2 as below :

Fig9-2 Definition of Viewing Angle

*5) Definition of Response Time.(White-Black)

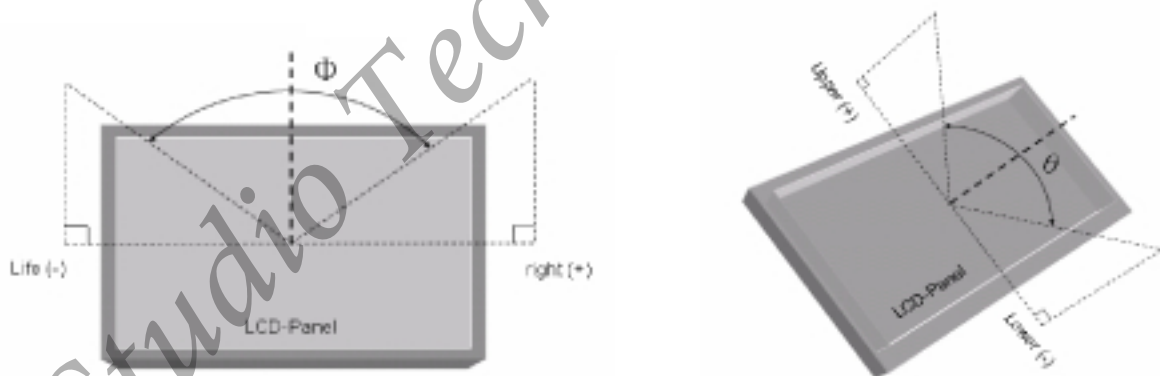
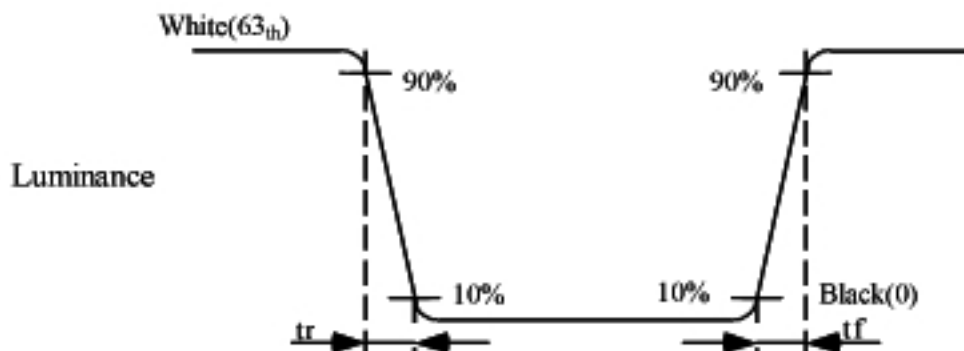

Fig9-3 Definition of Response Time(White-Black)

Studio Technology Co., Ltd

10. RELIABILITY TEST

10.1. Temperature and humidity

TEST ITEMS	CONDITIONS	REMARK
High Temperature Operation	85°C · 240Hrs	
High Temperature Storage	95°C · 240Hrs	
High Temperature High Humidity Operation	60°C · 90%RH · 240Hrs	No condensation
Low Temperature Operation	-30°C · 240Hrs	
Low Temperature Storage	-40°C · 240Hrs	
Thermal Shock	-30°C (0.5Hr) ~ 85°C(0.5Hr) 200 cycles	

10.2. Shock and Vibration

TEST ITEMS	CONDITIONS
Shock (Non-operation)	<ul style="list-style-type: none"> ● Shock level:980m/s²(equal to 100G) ● Waveform:half sinusoidal wave,6ms. ● Number of shocks:one shock input in each direction of three mutually perpendicular axes for a total of three shock inputs.
Vibration (Non-operation)	<ul style="list-style-type: none"> ● Frequency range:8~33.3Hz ● Stoke:1.3mm ● Vibration: sinusoidal wave, perpendicular axis(both x, z axis:2Hrs,y axis:4Hrs). ● Sweep:2.9G,33.3Hz-400Hz ● Cycle:15min

10.3 Judgment standard

The Judgment of the above test should be made as follow:

Pass:Normal display image with no obvious non-uniformity and no line defect.Partial trasformation of the module parts should be ignored.

Fail:No display image,obvious non-uniformity,or line defect.

CONTENTS

1. OVERVIEW	4
2. ABSOLUTE MAXIMUM RATINGS	5
3. ELECTRICAL CHARACTERISTICS	6
3.1 TFT LCD	6
3.2 TFT-LCD Current Consumption	7
3.3 Power - signal sequence.....	7
4. INTERFACE CONNECTION	8
5. INPUT SIGNAL(DE ONLY MODE)	10
5.1 Timing Specification	10
5.2 Timing sequence(Timing chart).....	11
5.3 LVDS Input Data mapping	12
5.4 Color Data Assignment.....	13
6. CHARACTERISTIC OF TOUCH PANEL	14
6.1 Basis characteristic	14
6.2 Design guideline for Touch Panel.....	14
6.3 Circuit Diagram	14
7. BLOCK DIAGRAM	15
8. MECHANICAL DIMENSION	16
8.1 Front Side.....	16
8.2 Rear Side.....	16
9. OPTICAL CHARACTERISTICS	17
10. RELIABILITY TEST	20
10.1. Temperature and humidity.....	20
10.2. Shock and Vibration.....	20
10.3 Judgment standard	20

1. OVERVIEW

CLAA070NA01CT is 7" color TFT-LCD(Thin Film Transistor Liquid Crystal Display)module which integrates Touch-Screen.Composed of LCD panel,driver ICs,control circuit,and LED backlight.

The 7.0"screen produces a high resolution image that is composed of 1024×600 pixel elements in a stripe arrangement.Display 262K colors by 6 Bit R.G.B signal input.

General specifications are summarized in the following table :

ITEM	SPECIFICATION
Display Area (mm)	153.6(H)×90(V)
Number of Pixels	1024(H)×3(RGB)×600(V)
Pixel Pitch (mm)	0.15(H)×0.15(V)
Color Pixel Arrangement	RGB vertical stripe
Display Mode	Normally white
Number of colors	262,144
Viewing Direction	6 o'clock
Response Time (Tr+Tf)	20ms
Brightness(cd/m ²)	200 nit(min)/250nit(typ)
Viewing Angle(BL on,CR≥10)	140 degree(H) · 110degree(V)
Electrical Interface(data)	LVDS
Power consumption	2.625W (TYP)
Outline Dimension(in mm)	165(W)×102(H)×6(D)
Weight(g)	138
BL unit	LED
Surface Treatment	Anti-Glare · Hardness:3H
Touch Panel Type	4 wire resistive

Studio Technology Co., Ltd

2. ABSOLUTE MAXIMUM RATINGS

Item	Symbol	Min.	Max.	Unit	Note
LCD input Voltage	V _{cc}	-0.3	4.0	V	
LED input Voltage	V _{LED}	-0.3	6	V	
Signal Input Voltage	RxIN0+ ~ RxIN2+ RxIN0- ~ RxIN2- Rx CLK IN +/-	-0.3	V _{cc} +0.3	V	
Static Electricity	VESDc	-200	+200		*2)
	VESDm	-15K	+15K	V	
ICC Rush Current	IRUSH	--	1	A	*3)
Operation Temperature	T _{op}	-30	85	°C	*1)
Storage Temperature	T _{stg}	-40	95	°C	*1)

Remarks :

*1) If users use the product out off the environment operation range (temperature and humidity) it will concern for visual quality.

*2) Test Condition: IEC 61000-4-2 ,

VESDc : Contact discharge to input connector

VESDm : Contact discharge to module

*3) Control signal: High(+3.3V)→Low(GND)

Supply Voltage of rising time should be from R3 and C2 tune to 550 us

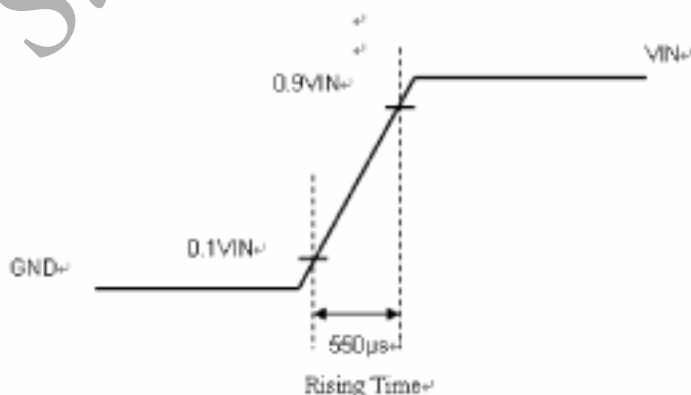
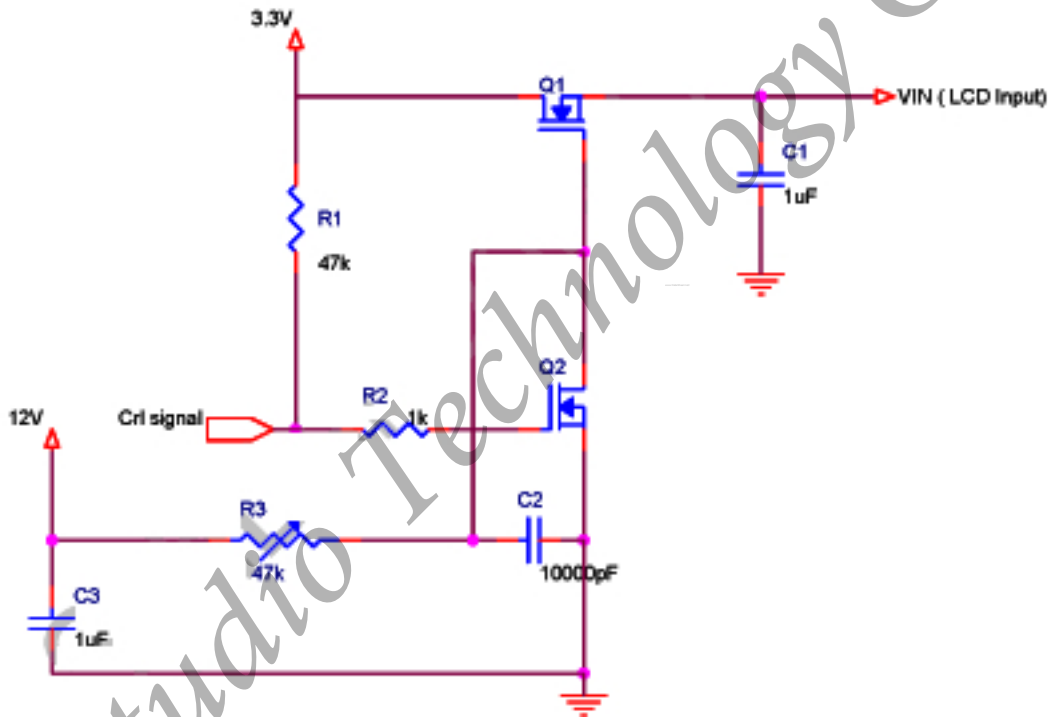

3. ELECTRICAL CHARACTERISTICS

3.1 TFT LCD

Ta=25°C

Item	Symbol	Min.	Typ	Max.	Unit	Note
Power Supply Voltage For LCD	VCC	3.0	3.3	3.6	V	
Power Supply Voltage For LED	VLED	4.5	5.0	5.5		
Logic Input Voltage (LVDS:IN+,IN-)	VCM	1.08	1.2	1.32	V	*1)
	VID	250	350	450	mV	*1)
	VTH	--	--	100	mV	*1)
	VTL	-100	--	--	mV	*1) When VCM=+1.2V
ADJ Input Voltage	VIH	3.0		3.3	V	
	VIL	GND		0.3	V	

Remarks :

*1) LVDS signal

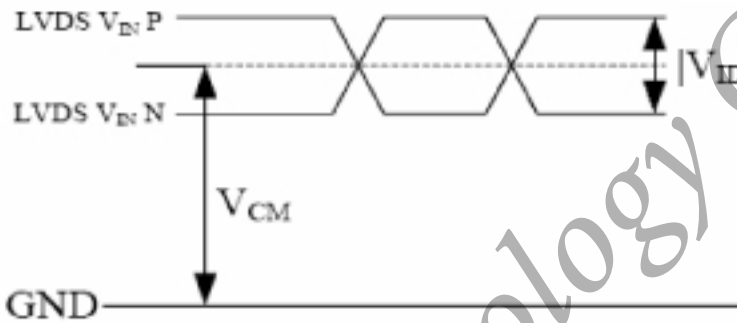

$$|V_{ID}| = |V_{TH} - V_{TL}|$$

$$V_{CM} = (V_{TH} + V_{TL})/2$$

Studio Technology Co., Ltd.

3.2 TFT-LCD Current Consumption

ITEM	SYMBOL	MIN	TYP	MAX	UNIT	REMARK
LCD Power Current	ICC	--	250	300	mA	*1)
LED Power Current	IDD		400	450	mA	*2)

*1) Typical: Under 64 gray pattern
Maximum: Under black pattern



(a)64 Gray Pattern

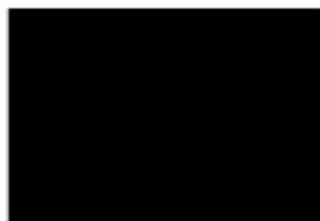

(b)Black Pattern

*2) Typical: When VDD is 5V
Maximum: When VDD is 4.5V

3.3 Power · signal sequence

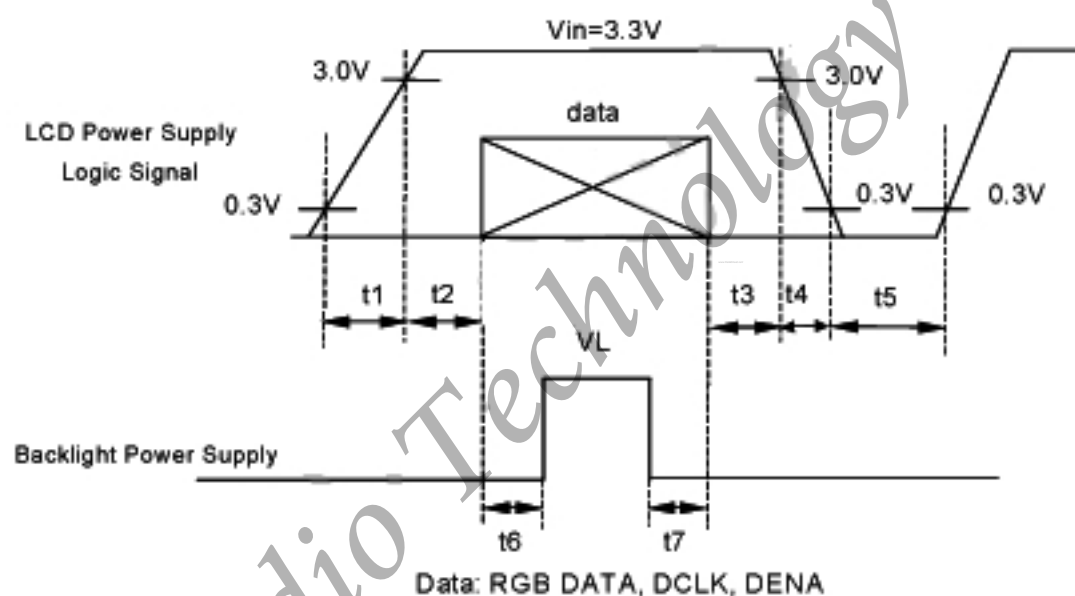

$t1 \leq 10\text{ms}$ $1 \text{ sec} \leq t5$
 $0 < t2 \leq 50\text{ms}$ $200\text{ms} \leq t6$
 $0 < t3 \leq 50\text{ms}$ $200\text{ms} \leq t7$
 $0 < t4 \leq 10\text{ms}$

4. INTERFACE CONNECTION

Pin NO.	SYMBOL	DESCRIPTION
1	AVSS	Power Ground
2	VCC	Power Supply for Digital circuit
3	VCC	Power Supply for Digital circuit
4	NC	NC
5	ADJ	Adjust for LED brightness
6	NC	NC
7	AVSS	Power Ground
8	RXIN0-	Negative LVDS differential data inputs
9	RXIN0+	Positive LVDS differential data inputs
10	AVSS	Power Ground
11	RXIN1-	Negative LVDS differential data inputs
12	RXIN1+	Positive LVDS differential data inputs
13	AVSS	Power Ground
14	RXIN2-	Negative LVDS differential data inputs
15	RXIN2+	Positive LVDS differential data inputs
16	AVSS	Power Ground
17	RXCLK-	Negative LVDS differential clock inputs
18	RXCLK+	Positive LVDS differential clock inputs
19	AVSS	Power Ground
20	NC	NC
21	NC	NC
22	NC	NC
23	NC	NC
24	VLED	Power Supply for LED(Vled=5.0±0.5)
25	VLED	Power Supply for LED(Vled=5.0±0.5)
26	VLED	Power Supply for LED(Vled=5.0±0.5)
27	YD	Touch Panel control pin
28	XL	Touch Panel control pin
29	YU	Touch Panel control pin
30	XR	Touch Panel control pin

Remarks :

- 1) NC Pin must be retain, this pin can't contact GND or other signal.
- 2) GND Pin must ground contact · can not be floating.
- 3) Touch Panel Control

Pin No.	Symbol	function
1	YU	Y axis resistance
2	XR	X axis resistance
3	YD	Y axis resistance
4	XL	X axis resistance

4) ADJ adjust brightness to control Pin · Pulse duty the more big the more bright

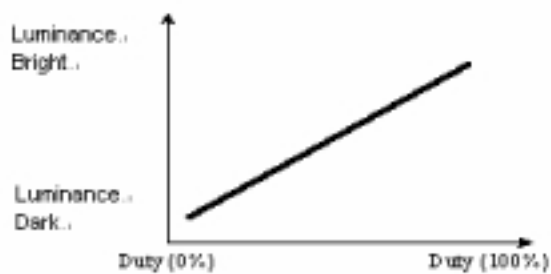

5) ADJ signal=0~3.3V · operation frequency : $20 \pm 5\text{KHz}$

$F = 20\text{KHz} \cdot T = 0.05\text{ms}$

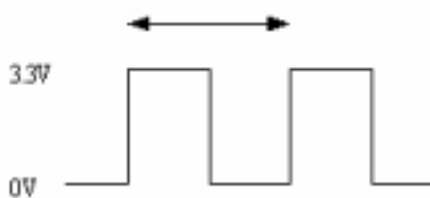

Studio Technology Co., Ltd