



Chunghwa Picture Tubes, Ltd.

Product Specification

To : EMB

Date : 20120711

TFT LCD

CLAA080XA12LE

ACCEPTED BY : (V0.2)

APPROVED BY	CHECKED BY	PREPARED BY
鍾昭玟	劉志洪	鄭丹蘋

Prepared by :

Product Planning Management Division
Small & Medium TFT Product Business Unit

CHUNGHWA PICTURE TUBES, LTD.

1127 Hopin Rd., Padeh, Taoyuan, Taiwan 334, R.O.C.
TEL: +886-3-3675151 FAX: +886-3-377-3858

Doc.No:	SPEC_CLAA080XA12LE_V0.2_CPT_120711	Issue Date:	2012.07.11
---------	------------------------------------	-------------	------------

CONTENTS

1. OVERVIEW	4
2. ABSOLUTE MAXIMUM RATINGS	5
3. ELECTRICAL CHARACTERISTICS	6
3.1 TFT LCD	6
3.2 TFT-LCD Current Consumption	7
3.3 Power 、 Signal sequence	7
3.4 Backlight	8
4. INTERFACE CONNECTION	9
4.1 CN1 (Input Signal)	9
5. INPUT SIGNAL(DE ONLY MODE)	11
5.1 Timing Specification	11
5.2 Timing sequence(Timing chart)	11
6. MECHANICAL DIMENSION	13
6.1 Front Side	13
6.2 Rear Side	14
7. OPTICAL CHARACTERISTICS	15
8. RELIABILITY TEST	17
8.1. Temperature and humidity	17
8.2. Shock and Vibration	17
8.4. Judgment standard	17
9. WARRANTY	18
9.1 The period is within 12 months since the date of shipping out under normal using ..	18
and storage conditions.	18
9.2 The warranty will be avoided in case of defect induced by customer	18

1. OVERVIEW

CLAA080XA02BE is 8" color TFT-LCD (Thin Film Transistor Liquid Crystal Display) module composed of LCD panel, driver ICs, control circuit and LED backlight. By applying 1024x768 images are displayed on the 8" diagonal screen. Display 16.2M colors by R.G.B signal input.

General specification are summarized in the following table:

ITEM	SPECIFICATION
Display Area (mm)	162.048(W) x 121.536(H)
Number of Pixels	1024(H) x 3 (RGB) x 768(V)
Pixel Pitch (mm)	0.15825(W) x 0.15825(H)
Color Pixel Arrangement	RGB vertical stripe
Display Mode	Normally white
Number of Colors	16.2M
Viewing Direction	4:30 o'clock
Brightness (cd/m ²)	300nit(typ)
Response Time (ms)	20ms(typ.)
NTSC	50%(typ.)
Contrast Ratio	700:1(typ)/500:1(min)
Viewing Angle (CR ≥ 10)	140degree (Horizontal.)
	140degree (Vertical)
Power Consumption (W)	2.21W(Typ)
Interface connection	LVDS
Module Size (mm)	183(W) x 141(H) x 3.4(D)
Module Weight (g)	170(TYP)
Backlight Unit	LED
Surface Treatment	Glare

2. ABSOLUTE MAXIMUM RATINGS

The following are maximum values which, if exceeded, may cause faulty operation or damage to the unit.

Item	Symbol	Min.	Max.	Unit	Note
Digital Supply Voltage	VDD VDD_LVDS	-0.3	5	V	
Analog Supply Voltage	AVDD	-0.5	15	V	
Gate On Voltage	VGH	-0.3	40	V	
Gate Off Voltage	VGL	-20	0.3	V	
Gate On-Gate Off Voltage	VGH-VGL	-0.3	40	V	
Signal Input Voltage	NIND0 ~ NIND3 PIND0 ~ PIND3 NINC,PINC	-0.5	5	V	
Forward Current (per LED)	I _f	-	30	mA	
Reverse Voltage (per LED)	VR	-	5	V	
Pulse forward current (per LED)	I _{fp}	-	100	mA	Note 1、2
Operating temperature	Topa	-10	50	°C	Note3
Storage temperature	Tstg	-20	60	°C	Note3

Note1 : I_{fp} Conditions : Pulse Width ≤ 10msec ; Duty ≤ 1/10

Note2 : perating must under the condition as below drawing.

(Ambient Temperature /Allowable Forward Current) Each LED .

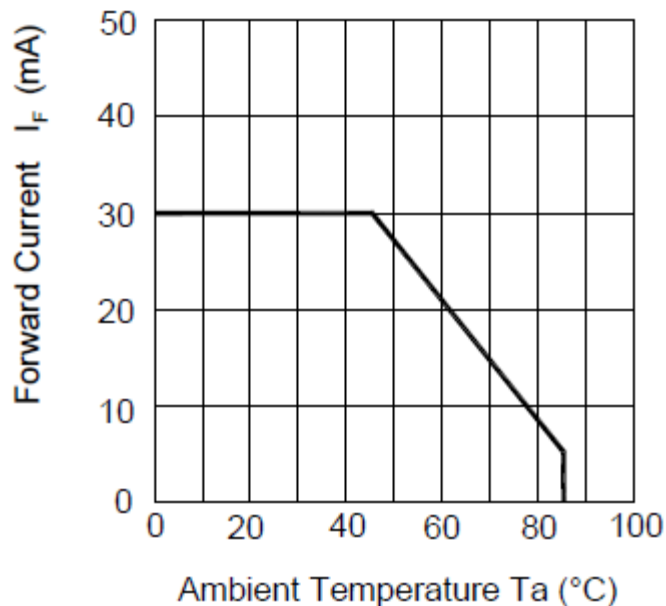

Note3: If users use the product out off the environmental operation range (temperature and humidity) , it will have visual quality concerns.

3. ELECTRICAL CHARACTERISTICS

3.1 TFT LCD

Ta=25°C

ITEM	SYMBOL	MIN	TYP	MAX	UNIT	NOTE
Digital Power Supply Voltage For LCD	VDD VDD_LVDS	3	3.3	3.6	V	
Logic Input Voltage (LVDS:IN+,IN-)	VCM	$\frac{ VID }{2}$	-	$2.4 - \frac{ VID }{2}$	V	Note1
	VID	200	-	600	mV	Note1
	VTH	-	-	100	mV	VCM=1.2V Note1
	VTL	-100	-	-	mV	
Analog Power Supply Voltage	AVDD	TBD	9.6	TBD	V	
Gate On Power Supply Voltage	VGH	17	18	19	V	
Gate Off Power Supply Voltage	VGL	-6.6	-6	-5.4	V	
Common Power Supply Voltage	VCOM	3.7	3.9	4.1	V	Note2

【Note1】 LVDS signal

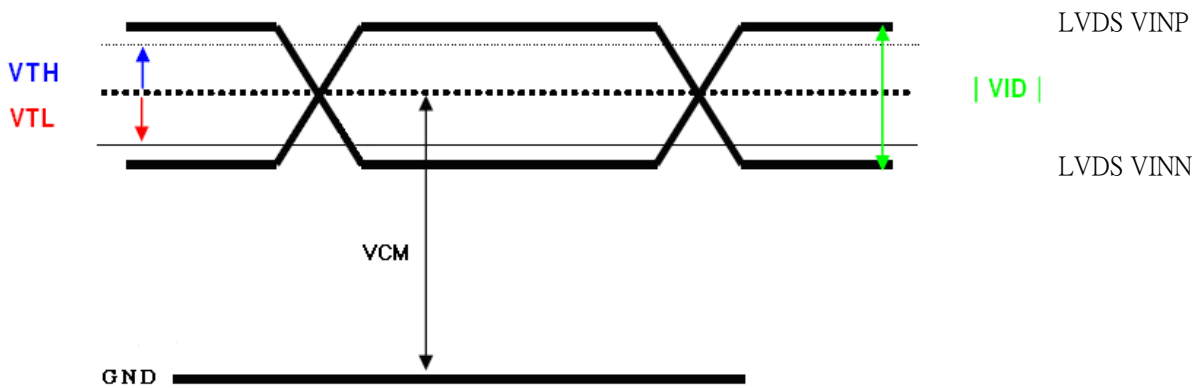

【Note2】 Please adjust VCOM to make the flicker level be minimum.

3.2 TFT-LCD Current Consumption

ITEM	SYMBOL	Condition	MIN	TYPE	MAX	UNIT	NOTE
Gate on power current	IVGH	VGH = 18V	-	0.5	1	mA	Note1
Gate off power current	IVGL	VGL = -6V	-	0.5	1	mA	Note1
Digital power current	IVDD	VDD = 3.3V	-	38	45	mA	Note1
Analog power current	IAVDD	AVDD = 9.6V	-	26	37	mA	Note1
Total Power Consumption	PC		-	387	528	mW	Note1

Note1: Typical: Under 256 gray pattern
Maximum: Under black pattern



256 gray pattern



Black Pattern

3.3 Power · Signal sequence

Power On : VDD → AVDD/VGL → VGH → Video & Logic Signal → Backlight
Power Off : Backlight → Video & Logic Signal → VGH → AVDD/VGL → VDD

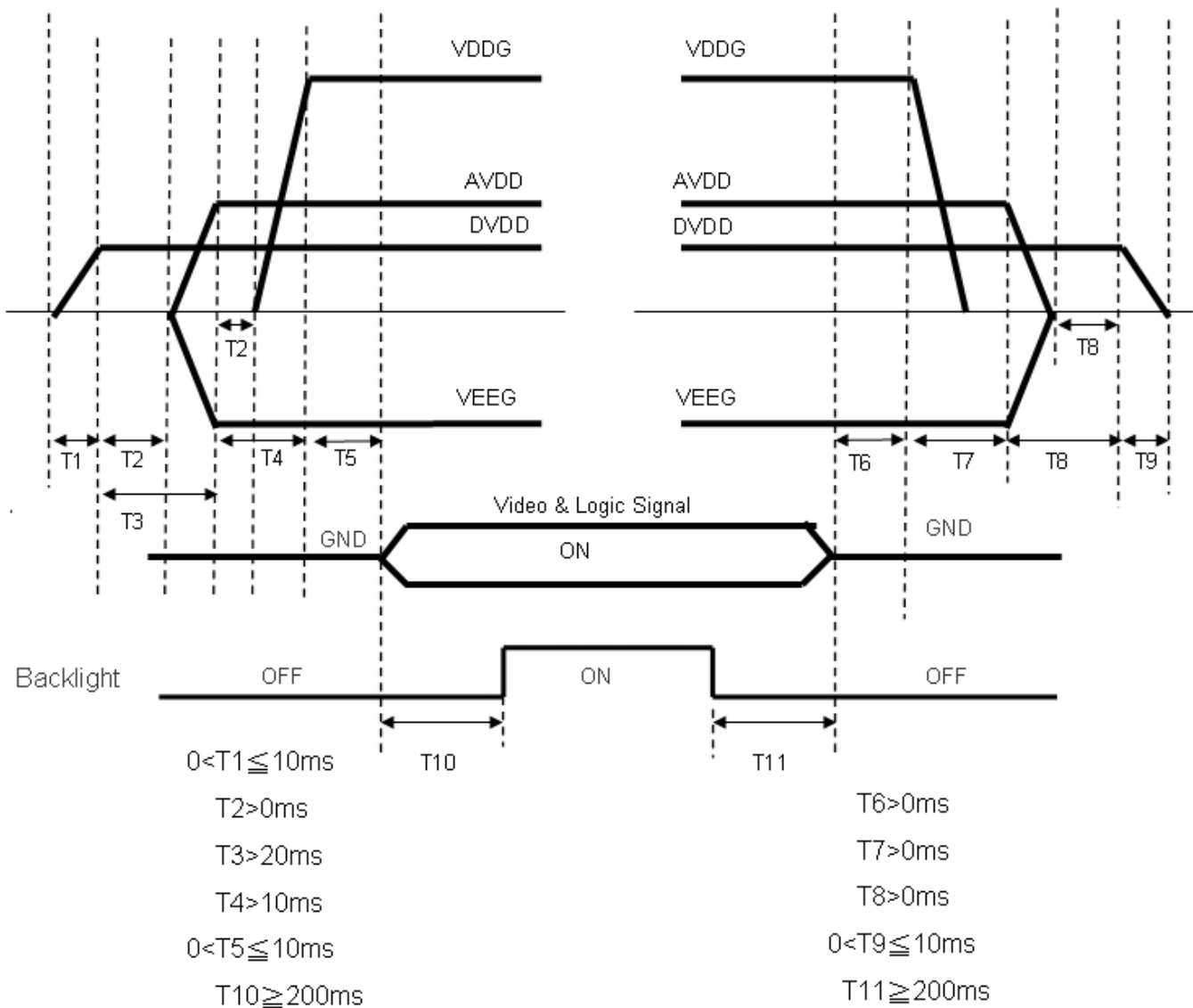

3.4 Backlight

Ta=25°C

ITEM	SYMBOL	CONDITIONS	MIN	TYP	MAX	UNIT	NOTE
LED current	IL	Ta=25°C (20mA/serise)	--	180	--	mA	
LED voltage	VL	Ta=25°C (20mA/serise)	8.55	9.6	10.65	V	
Power consumption	WL	Ta=25°C (20mA/serise)	--	1.728	--	W	
LED Lifetime	-	Ta=25°C IF=20mA	20000			Hr	

Remarks :

*1)LED Circuit Diagram

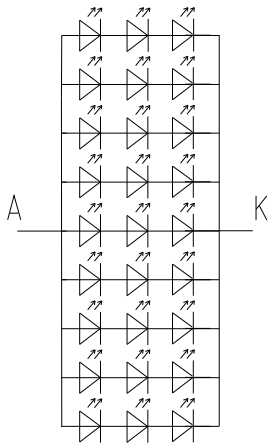

*2) A : Anode(+) , K : Cathode(-)

*3) Suggestion: Using the constant current control to avoid the leakage light and brightness quality issue.

*4) Definition of Led lifetime : Luminance < Initial luminance 50%.

4. INTERFACE CONNECTION

4.1 CN1 (Input Signal)

PIN NO	SYMBOL	DESCRIPTION
1	VCOM	Common voltage
2	VDD	Digital power
3	VDD	Digital power
4	NC	Not connect
5	GRB	Global reset pin. Active low to enter reset state. Suggest to connecting with an RC reset circuit for stability. Normally pull high. (R=10K Ω , C=0.1 μ F)
6	STBYB	Standby mode, normally pull high STBYB=" 1" , normal operation STBYB=" 0" ,timing control, source driver will turn off, all output are high-Z
7	GND	Digital ground
8	NIND0	Negative LVDS differential data inputs
9	PIND0	Positive LVDS differential data inputs
10	GND	Digital ground
11	NIND1	Negative LVDS differential data inputs
12	PIND1	Positive LVDS differential data inputs
13	GND	Digital ground
14	NIND2	Negative LVDS differential data inputs
15	PIND2	Positive LVDS differential data inputs
16	GND	Digital ground
17	NINC	Negative LVDS differential clock inputs
18	PINC	Positive LVDS differential clock inputs
19	GND	Digital ground
20	NIND3	Negative LVDS differential data inputs
21	PIND3	Positive LVDS differential data inputs
22	GND	Digital ground
23	NC	Not connect
24	NC	Not connect
25	GND	Digital ground
26	NC	Not connect
27	NC	Not connect
28	SELB	6-bit/8-bit input select SELB = L , 8-bit ; SELB = H , 6-bit
29	AVDD	Analog power
30	GND	Digital ground
31	VLED-	LED Cathode
32	VLED-	LED Cathode
33	SHLR	Left or right display control
34	UPDN	Up / down display control
35	VGL	Negative power for TFT
36	NC	Not connect
37	NC	Not connect
38	VGH	Positive power for TFT
39	VLED+	LED Anode
40	VLED+	LED Anode

Remarks :

- 1) Mating connector : 089N40-000100-G2-R (STARCONN)
- 2) UPDN and SHLR control function

UPDN	SHLR	FUNCTION
0	1	Normal display
0	0	Inverse Left and Right
1	1	Inverse Up and Down
1	0	Inverse Left and Right Inverse Up and Down

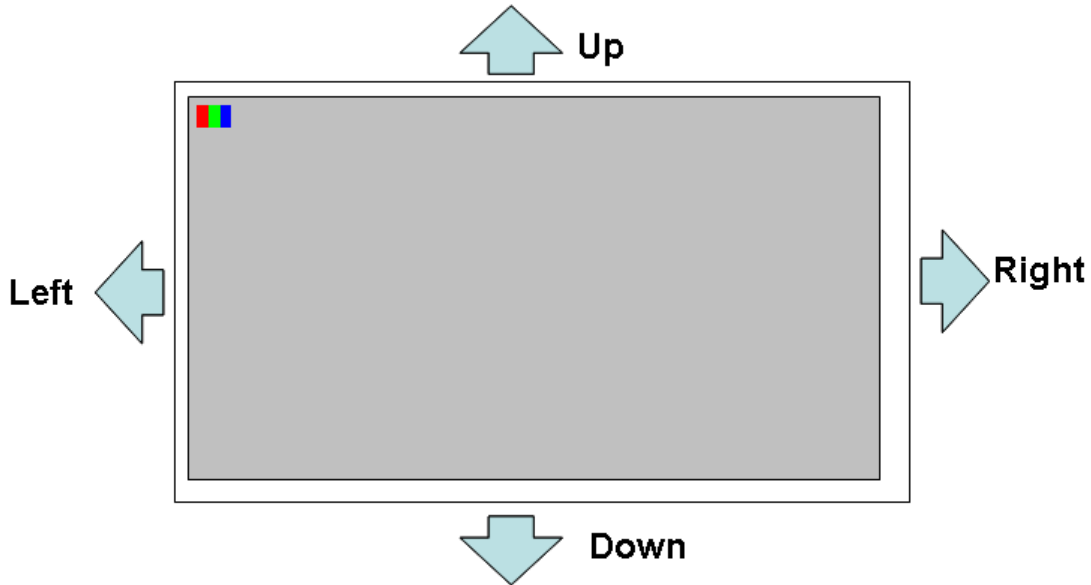

5. INPUT SIGNAL(DE ONLY MODE)

5.1 Timing Specification

ITEM			SYMBOL	MIN	TYP	MAX	UNIT	
LVDS input signal sequence	CLK Frequency		tclk	58	65	71	MHz	
LCD input signal sequence (Input LVDS Transmitter)	DENA	Horizontal	Horizontal total Time	t _H	1324	1344	1350	tCLK
			Horizontal effective Time	t _{HA}	1024			tCLK
			Horizontal Blank Time	t _{HB}	300	320	326	tCLK
	Vertical	Vertical total Time	t _V	796	806	810	t _H	
		Vertical effective Time	t _{VA}	768			t _H	
		Vertical Blank Time	t _{VB}	28	38	42	t _H	

5.2 Timing sequence(Timing chart)

5.2.1 Horizontal Timing Sequence

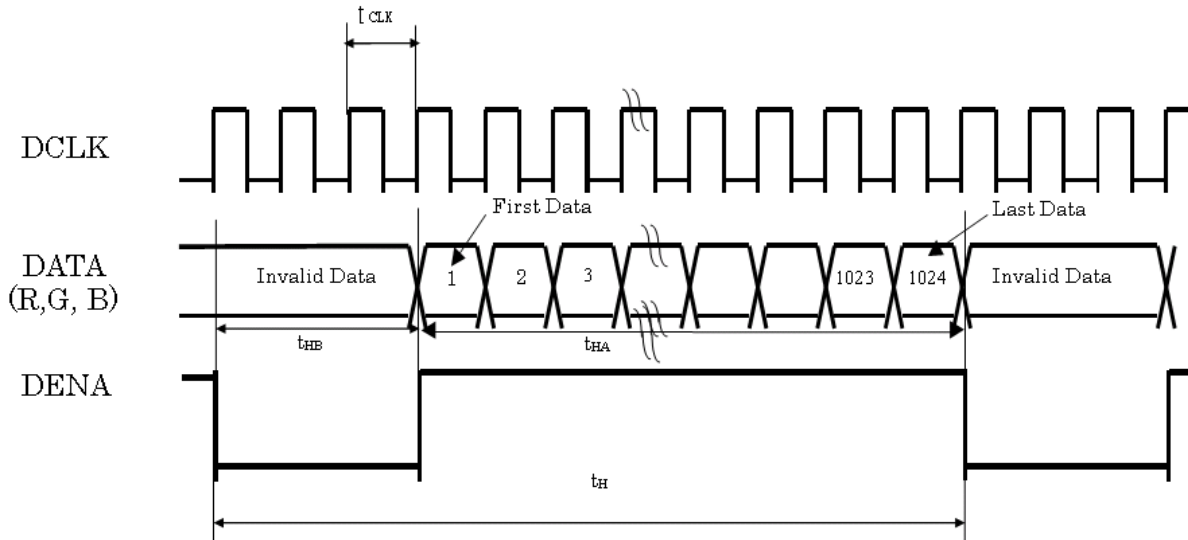

5.2.2 Vertical Timing Sequence

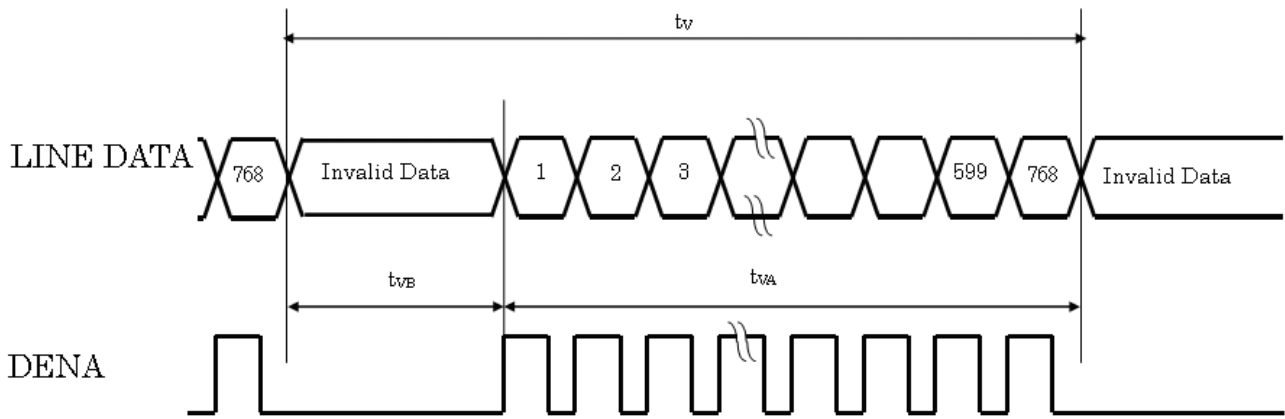

5.2.3 LVDS Input Data mapping

6 Bit LVDS input

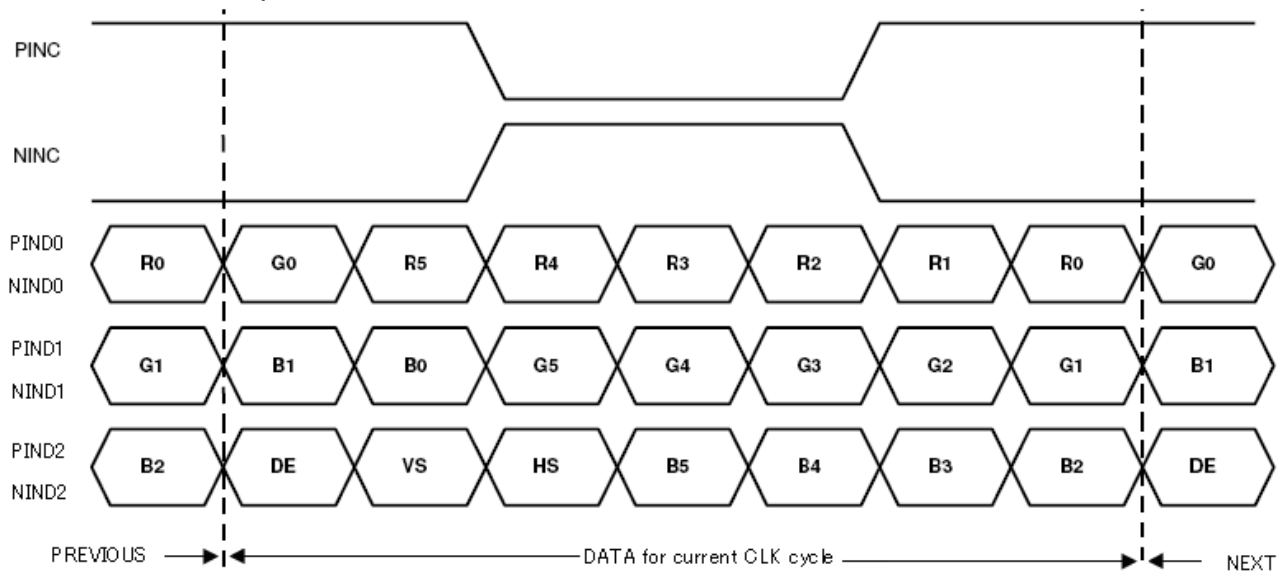

8 Bit LVDS input

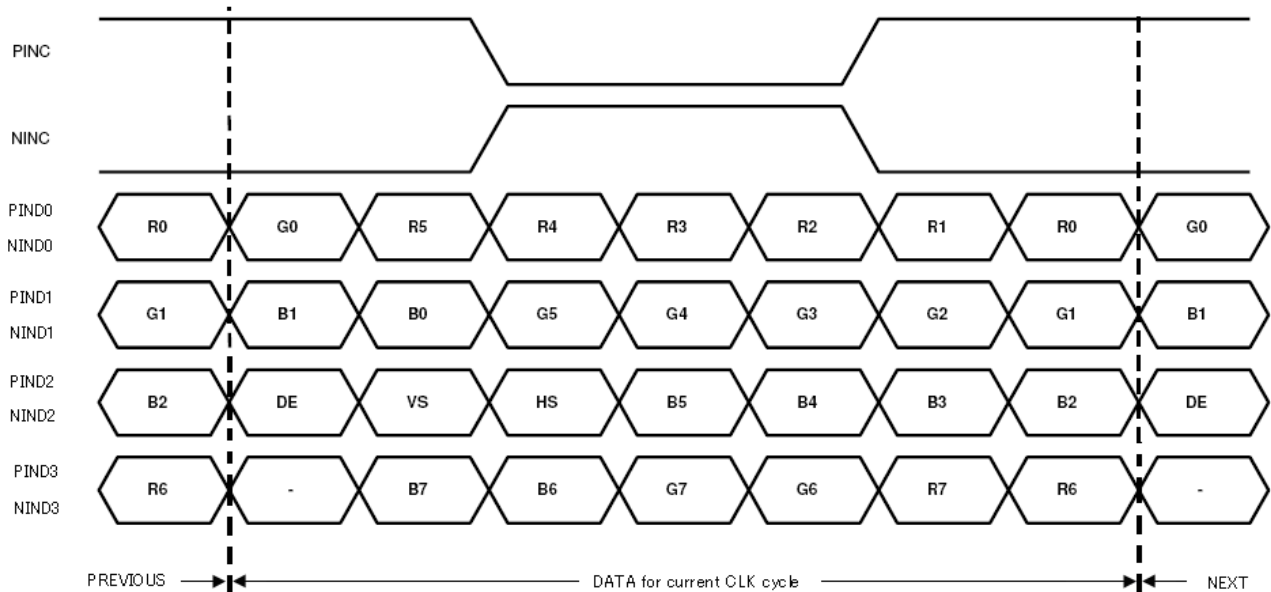

6. MECHANICAL DIMENSION

6.1 Front Side

[Unit : mm]

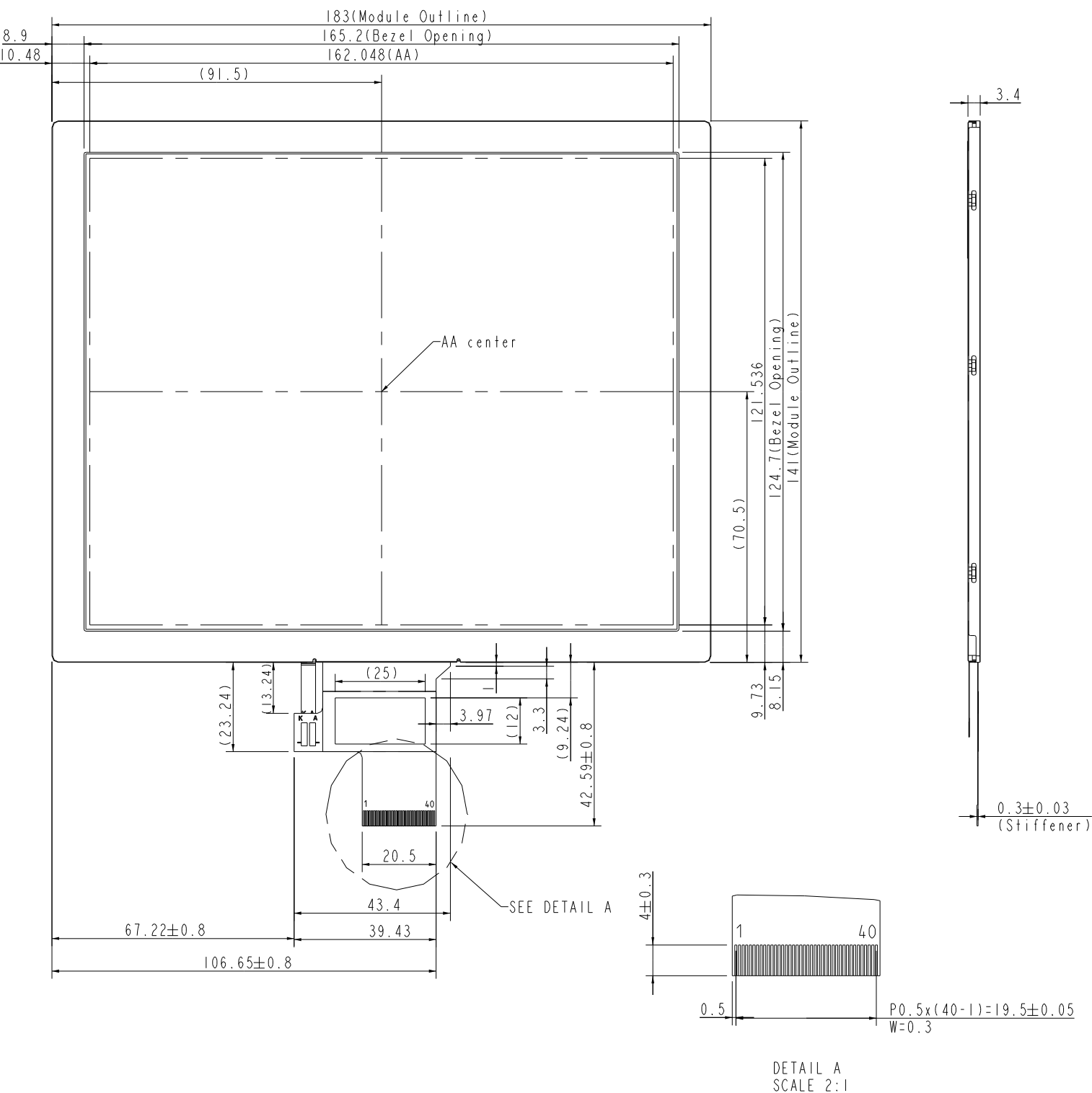

6.2 Rear Side

[Unit : mm]

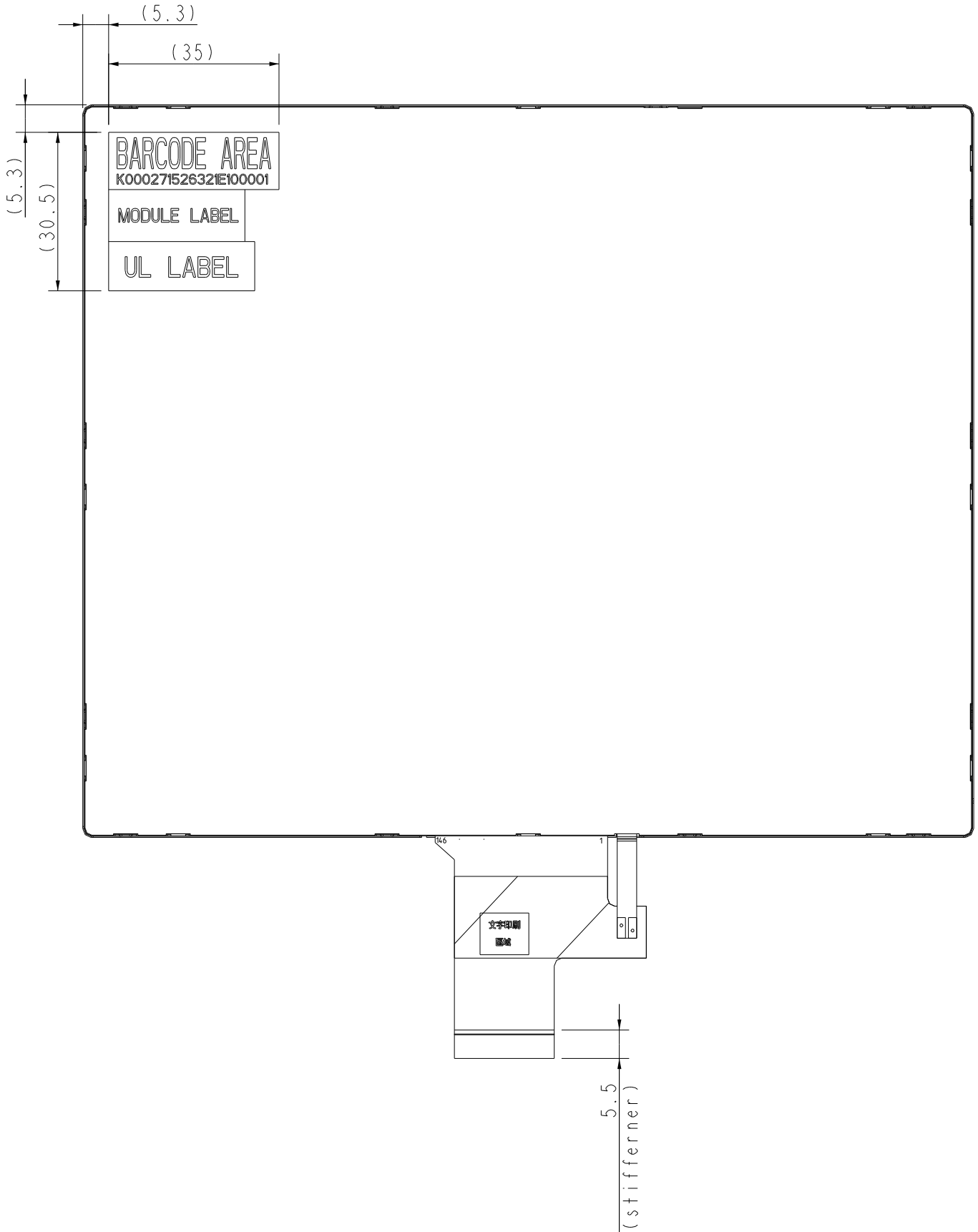

Remark : General tolerance $\pm 0.3\text{mm}$

7. OPTICAL CHARACTERISTICS

Ta = 25°C, VCC=3.3V

ITEM	SYMBOL	CONDITIONS	MIN	TYP	MAX	UNIT	NOTE	
Constrast Ratio	CR	Point-5	500	700		--	1, 2, 3	
Luminance(CEN)	Lw	Point-5	240	300		cd/m ²	1, 3	
Luminance Uniformity	ΔL		70	75		%	1, 3	
Response Time (White - Black)	Tr +Tf	Point-5	-	20	40	ms	1, 3, 5	
NTSC	-	Point-5	45	50	-	%	1, 3	
Viewing Angle	Left	Deg.	CR ≥ 10 Point-5	65	75	--	°	1, 4
	Right	Deg.		60	70			1, 4
	Upper	Deg.		65	75	--	°	1, 4
	Lower	Deg.		60	70			1, 4
Color Coordinate	White	Wx Wy	Point-5	0.273 0.289	0.313 0.329	0.353 0.369	--	1, 3
	Red	Rx Ry		0.556 0.296	0.596 0.336	0.636 0.376		
	Green	Gx Gy		0.302 0.544	0.342 0.584	0.382 0.624		
	Blue	Bx By		0.123 0.068	0.163 0.108	0.203 0.148		

Note1: Measure condition : 25°C±2°C , 60±10%RH , under10 Lux in the dark room.BM-5A (TOPCON) , viewing angle2° , IL=180 mA (Backlight current) , measurement after lighting on 10 mins.

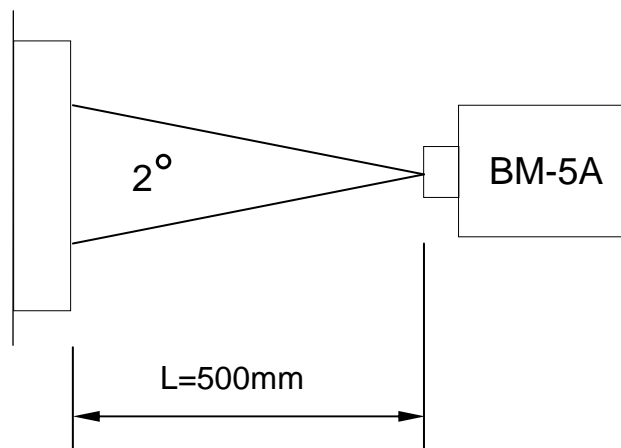

Note2: Definition of contrast ratio :

$$\text{Contrast Ratio (CR)} = (\text{White}) \text{ Luminance of ON} \div (\text{Black}) \text{ Luminance of OFF}$$

Note3: Definition of luminance : Measure white luminance on the point 5 as figure.6-1

Definition of Luminance Uniformity: Measure white luminance on the point1~9 as figure.6-1

$$\Delta L = [L(\text{MIN})/L(\text{MAX})] \times 100$$

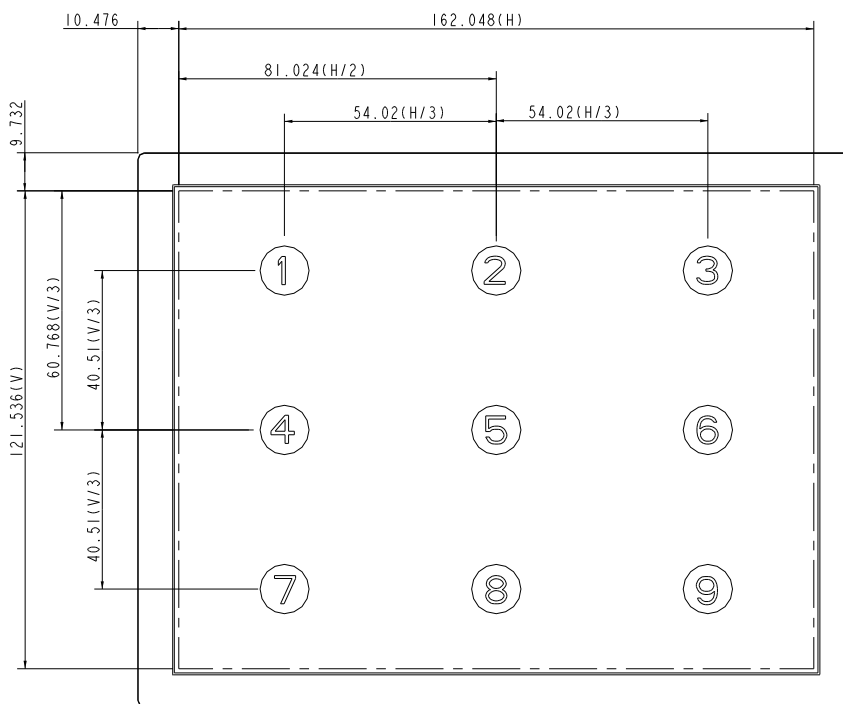

Fig.7-1 Measuring point

Note 4: Definition of Viewing Angle(θ, ψ), refer to Fig.7-2 as below :

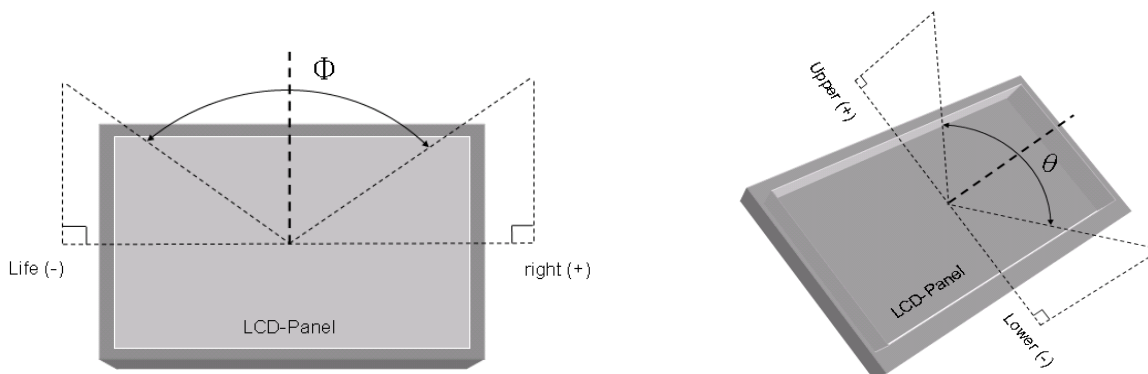

Fig.7-2 Definition of Viewing Angle

Note5: Definition of Response Time.(White-Black)

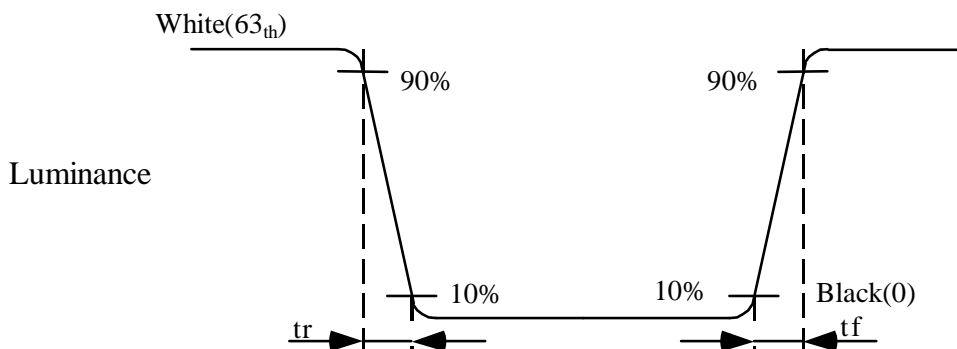

Fig.7-3 Definition of Response Time(White-Black)

8. RELIABILITY TEST

8.1. Temperature and humidity

TEST ITEMS	CONDITIONS	NOTE
High Temperature Operation	50°C ;240hrs	
High Temperature Storage	60°C ; 240hrs	
High Temperature High Humidity Operation	40°C ; 90%RH ;240hrs	No condensation
Low Temperature Operation	-10°C ; 240hrs	Backlight unit always turn on
Low Temperature Storage	-20°C ; 240hrs	
Thermal Shock	-20°C (0.5hr) ~ 60°C (0.5hr) ; 100 Cycles	
Image Sticking	25°C ; 24hrs	
MTFB	20000Hrs	

Note :

Condition of Image Sticking test : 25 °C ± 2 °C

Operation with test pattern sustained for 24 hrs, then change to gray pattern immediately.

After 5 mins, the mura must be disappeared completely .

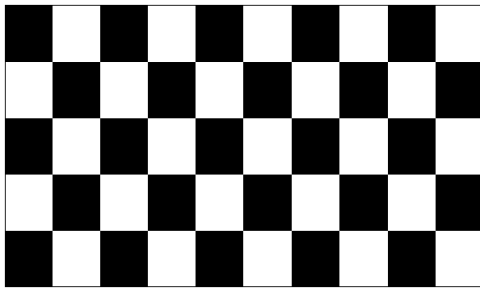

Image sticking pattern



mid-gray pattern

8.2. Shock and Vibration

TEST ITEMS	CONDITIONS
Shock (Non-operation)	<ul style="list-style-type: none"> ● Shock level: 980m/s²(equal to 100G). ● Waveform: half sinusoidal wave,6ms. ● Number of shocks: one shock input in each direction of three mutually perpendicular axes for a total of three shock inputs.
Vibration (Non-operation)	<ul style="list-style-type: none"> ● Frequency range:8~33.3Hz ● Stoke : 1.3 mm ● Vibration: sinusoidal wave, perpendicular axis(x, z axis: 2Hrs y axis: 4Hrs). ● Sweep: 2.9G,33.3 Hz -400 Hz ● Cycle: 15 min

8.3 Electrostatic Discharge

TEST ITEM	CONDITIONS	Note
ESD	150pF , 330Ω , ±8kV&±15kV air& contact test	1
	200pF , 0Ω , ±200V contact test	2

Note: Measure

1: LCD glass and metal bezel

2: IF connector pins

8.4. Judgment standard

The Judgment of the above test should be made as follow:

Pass:Normal display image with no obvious non-uniformity and no line defect.Partial transformation of the module parts should be ignored.

Fail:No display image,obvious non-uniform

9. WARRANTY

9.1 The period is within 12 months since the date of shipping out under normal using and storage conditions.

9.2 The warranty will be avoided in case of defect induced by customer