



Chunghwa Picture Tubes, Ltd.

Product Specification

To : RB

Date : 090402

TFT LCD

CLAA089NA0FCW

ACCEPTED BY : (V0.3)

Tentative

Prepared by :

Product Planning Management Division
Small & Medium TFT Product Business Unit
CHUNGHWA PICTURE TUBES, LTD.

Doc.No: SPEC_CLAA089NA0FCW_V0.3_RB_090402

Issue Date: 2009/02/11

REVISION STATUS

Revision Notice	Description	Page	Rev. Date
0.0	First revision (Tentative)	--	2008/07/07
0.1	Revise the Power Consumption	4	2008/07/16
0.1	Revise the Outline Dimension	4	2008/07/16
0.1	Revise the Power Supply Voltage for LED	5	2008/07/16
0.1	Revise the VCC-dip Condition	6	2008/07/16
0.1	Revise the LCD Power Current	6	2008/07/16
0.1	Revise the Power and Signal sequence	7	2008/07/16
0.1	Revise the Pin Assignment	8	2008/07/16
0.1	Revise the ADJ signal	9	2008/07/16
0.1	Revise the Timing Chart	10	2008/07/16
0.1	Revise the Front Side	14	2008/07/16
0.1	Revise the Temperature and Humidity	19	2008/07/16
0.1	Revise the Shock & Vibration	19	2008/07/16
0.1	Revise the ESD Test	19	2008/07/16
0.2	Revise the Module Weight	4	2008/12/15
0.2	Revise the Rear Side	14	2008/12/15
0.2	Revise the Color Coordinate	15	2008/12/15
0.3	Revise the Absolute Maximum Ratings	5	2009/02/11
0.3	Revise the Power and Signal sequence	7	2009/02/11
0.3	Revise the Block Diagram	12	2009/02/11

CONTENTS

1. OVERVIEW	4
2. ABSOLUTE MAXIMUM RATINGS	5
3. ELECTRICAL CHARACTERISTICS	6
3.1 TFT-LCD Power Supply Voltage	6
3.2 TFT-LCD Current consumption	6
3.3 Power and Signal sequence	7
4. INTERFACE CONNECTION	8
4.1 Pin Assignment	8
5. INPUT SIGNAL	10
5.1 Timing Specification	10
5.2 Timing Chart	10
6. BLOCK DIAGRAM	12
7. MECHANICAL DIMENSION	13
7.1 Front Side	13
7.2 Rear Side	14
8. OPTICAL CHARACTERISTICS	15
9. RELIABILITY TEST CONDITIONS	18
9.1 Temperature and Humidity	18
9.2 Shock & Vibration	18
9.3. ESD Test	18
9.4 Judgment Standard	18

1. OVERVIEW

CLAA089NA0FCW is 8.9" color TFT-LCD (Thin Film Transistor Liquid Crystal Display) module composed of LCD panel, driver ICs, control circuit and LED backlight.

The 8.9" screen produces 1024× RGB X600 resolution image. By applying 6 bits digital data, 262K color images are displayed. The LCD is driven by a single input voltage (3.3 V and 5V).

General specifications are summarized in the following table:

ITEM	SECIFICATION
Display Area (mm)	195.072 (H) × 114.3 (V)
Number of Pixels(dot)	1024(H) × 3(RGB)× 600(V)
Pixel Pitch (mm)	0.1905 (H) × 0.1905 (V)
Color Pixel Arrangement	RGB vertical stripe
Display Mode	Normally white, TN
Number of Color	262,144
Viewing Direction	6 o'clock
Response Time (Tr+Tf)	20 ms (typ.)
Brightness(cd/m ²)	300 nit (typ.)
Viewing Angle (CR ≥ 10)	140 degree (Horizontal) 120 degree (Vertical)
Electrical Interface	LVDS
Power Consumption(W)	2.9 W (typ.)
Outline Dimension(mm)	210(W) × 127.8(H) × 5.2(D)
Module Weight(g)	190 (typ.)
BL unit	LED
Surface Treatment	Anti-Glare, Surface hardness: 3H

2. ABSOLUTE MAXIMUM RATINGS

ITEM	SYMBOL	MIN.	MAX.	UNIT	NOTE
Power Supply Voltage for LCD	Vcc	-0.3	4.0	V	
Power Supply Voltage for LED	Vdd	-0.3	6.0	V	
Signal Input Voltage	RxIN0+ ~ RxIN2+ RxIN0- ~ RxIN2- Rx CLK IN +/-	-0.3	Vcc + 0.3	V	
Static Electricity	VESDc	-200	+200	V	【Note2】
	VESDm	-15K	+15K	V	
ICC Rush Current	IRUSH	-	1	A	【Note3】
Operation Temperature	T _{op}	-20	70	°C	【Note1】
Storage Temperature	T _{stg}	-30	80	°C	【Note1】

【Note】

【Note1】 If users use the product out off the environmenal operation range (temperature and humidity), it will have visual quality concerns.

【Note2】 Test Condition: IEC 61000-4-2

VESDc : Contact discharge to input connector

VESDm : Discontact discharge to module

【Note3】 The input pulse-current measurement system is as below:

Control signal: High (+3.3V)→Low (GND)

Supply Voltage of rising time should be from R3 and C2 tune to 550 μs.

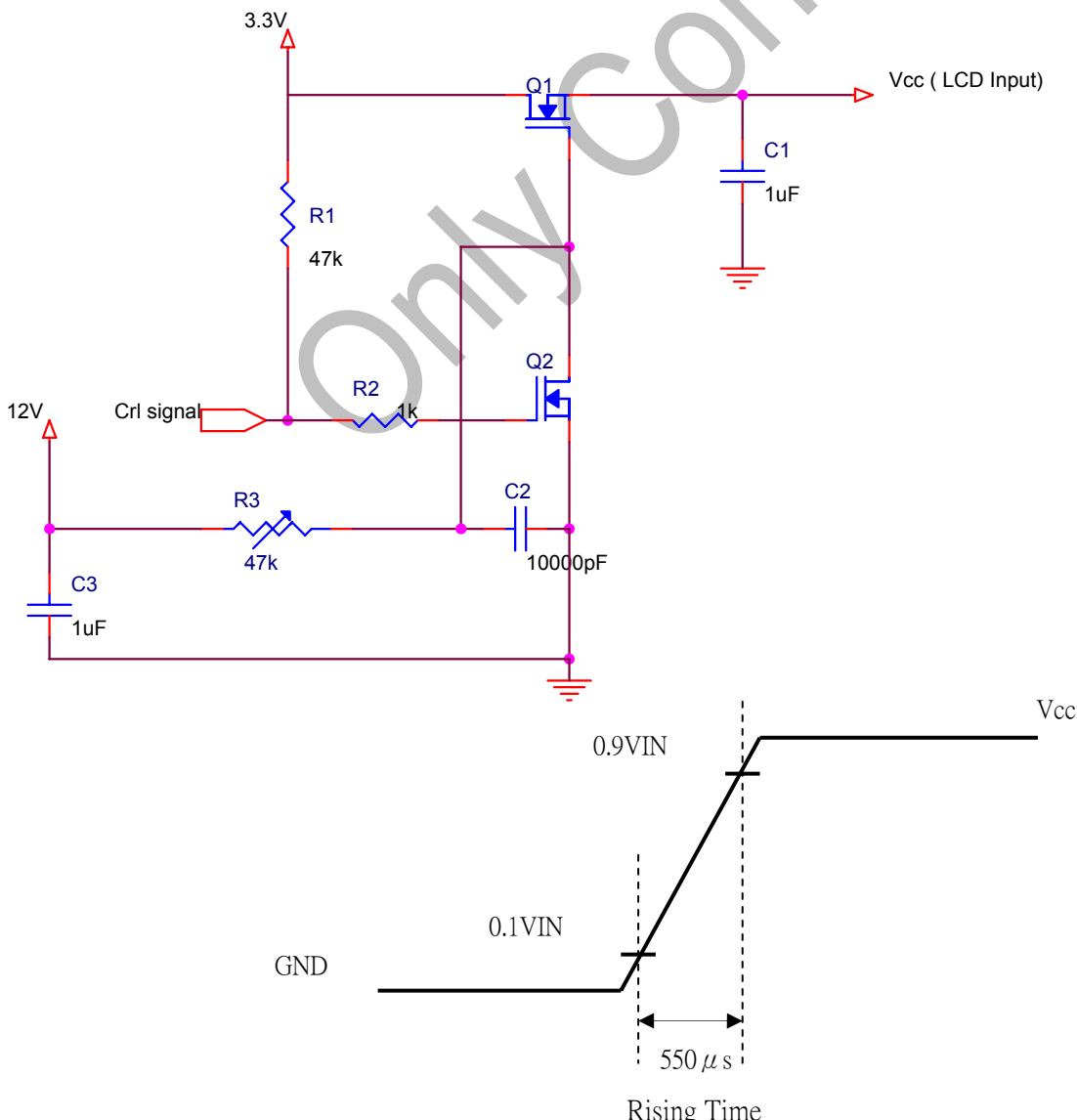

3. ELECTRICAL CHARACTERISTICS

3.1 TFT-LCD Power Supply Voltage

(Ta=25°C)

ITEM	SYMBOL	MIN.	Typ.	MAX.	UNIT	NOTE
Power Supply Voltage For LCD	VCC	3.0	3.3	3.6	V	
Power Supply Voltage For LED	VLED	4.5	5	5.5	V	
Logic Input Voltage	VIN	0	-	2.4	V	【Note1】
	VCM	0.3	1.2	2.1	V	【Note1】
	VID	0.1	-	0.6	V	【Note1】
	VTH	-	-	100	mV	【Note1】
	VTL	-100	-	-	mV	【Note1】
ADJ Input Voltage	VIH	3.0		3.3	V	
	VIL	GND		0.3	V	

【Note】

【Note1】 LVDS signal

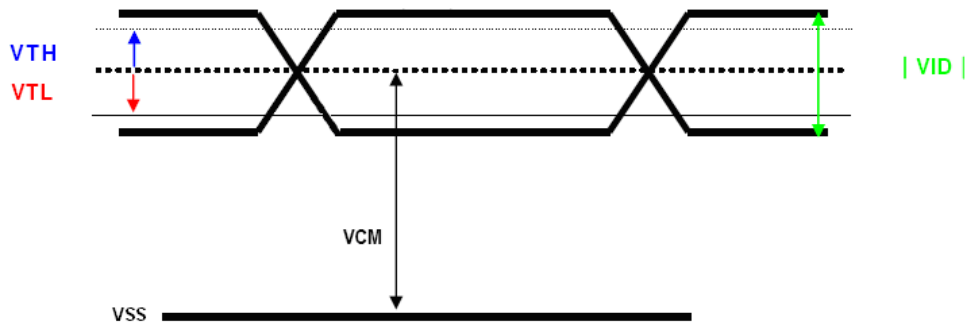

Note:

VCM: Common Mode Voltage Offset

| VID | : Differential Input Voltage

VTH: Differential Input High Threshold Voltage

VTL: Differential Input Low Threshold Voltage

3.2 TFT-LCD Current consumption

ITEM	SYMBOL	MIN.	TYP.	MAX.	UNIT	NOTE
LCD Power Current	ICC	--	240	300	mA	【Note1】
LED Power Current	IDD	--	420	480	mA	【Note2】

【Note】

【Note1】 Typical: Under 64 gray pattern

Maximum: Under black pattern



(a) 64 Gray Pattern

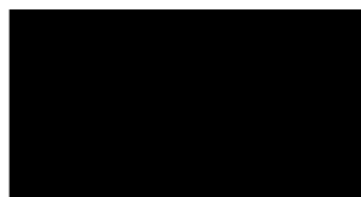

(b) Black Pattern

【Note2】 Typical: VDD = 5V

Maximum: VDD = 4.5V

3.3 Power and Signal sequence

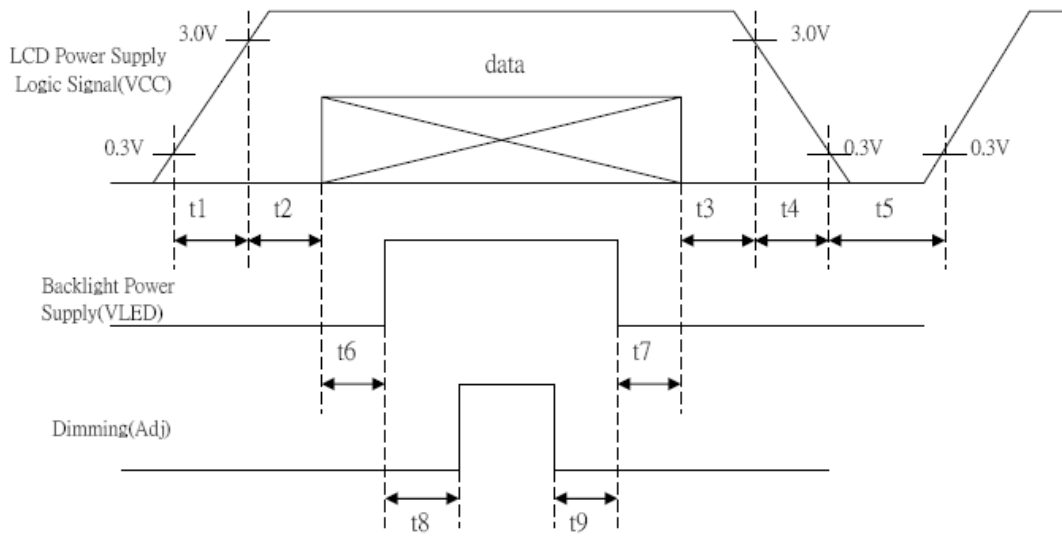

- $0.5 < t1 \leq 10\text{ms}$
- $0 < t2 \leq 50\text{ms}$
- $0 < t3 \leq 50\text{ms}$
- $0 < t4 \leq 10\text{ms}$
- $200\text{ms} \leq t5$
- $200\text{ms} \leq t6$
- $200\text{ms} \leq t7$
- $10\text{ms} \leq t8$
- $10\text{ms} \leq t9$

4. INTERFACE CONNECTION

4.1 Pin Assignment

PIN NO.	SYMBOL	DESCRIPTION
1	AVSS	Power Ground
2	VCC	Power Supply for Digital circuit
3	VCC	Power Supply for Digital circuit
4	NC	NC
5	ADJ	Brightness control for LED B/L
6	NC	NC
7	NC	NC
8	RXIN0-	Negative LVDS differential data inputs
9	RXIN0+	Positive LVDS differential data inputs
10	AVSS	Power Ground
11	RXIN1-	Negative LVDS differential data inputs
12	RXIN1+	Positive LVDS differential data inputs
13	AVSS	Power Ground
14	RXIN2-	Negative LVDS differential data inputs
15	RXIN2+	Positive LVDS differential data inputs
16	AVSS	Power Ground
17	RXCLK-	Negative LVDS differential clock inputs
18	RXCLK+	Positive LVDS differential clock inputs
19	AVSS	Power Ground
20	NC	NC
21	NC	NC
22	AVSS	Power Ground
23	AVSS	Power Ground
24	VLED	Power Supply for LED(VLED=5.0±0.5)
25	VLED	Power Supply for LED(VLED=5.0±0.5)
26	VLED	Power Supply for LED(VLED=5.0±0.5)
27	NC	NC
28	NC	NC
29	NC	NC
30	NC	NC

[Note]:

- 1) To reserve NC pin, don't make it connect with GND or any other signal.
- 2) AVSS pin must be connected with GND. Don't let it be an empty pin.
- 3) Adjust control pin (ADJ) controls brightness. The bigger pulse duty, the brighter luminance.

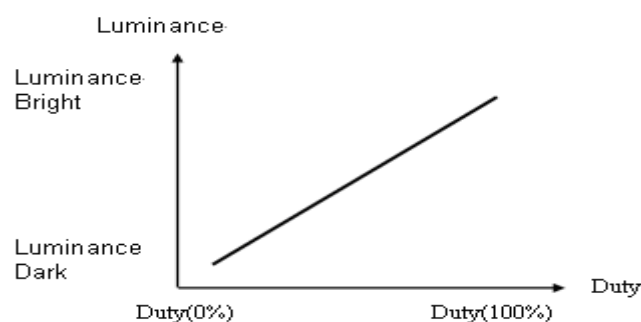

4) ADJ signal=0~3.3V, operation frequency: 47KHz±5KHz

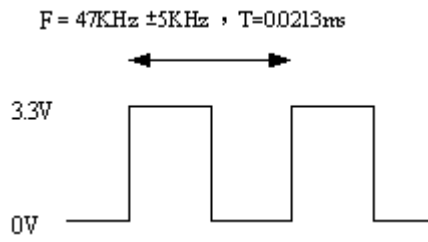

5) The ADJ should pull-high if not adjust brightness, this pin can't floating.

5. INPUT SIGNAL

5.1 Timing Specification

Item		SYMBOL	MIN.	TYP.	MAX.	UNIT	
LVDS	CLK frequency	fCLKin	39.05	45	51.42	MHz	
LCD Input timing	Horizontal	Horizontal Period	t_H	1160	1200	1240	tCLK
		Horizontal Valid	t_{HA}	1024	1024	1024	tCLK
		Horizontal Blank	t_{HB}	136	176	216	tCLK
	Vertical	Frame	fV	55	60	65	Hz
		Vertical Period	t_V	612	625	638	t_H
		Vertical Valid	t_{VA}	600	600	600	t_H
		Vertical Blank	t_{VB}	12	25	38	t_H

5.2 Timing Chart

- (1) Input Timing Diagram
Horizontal Timing:

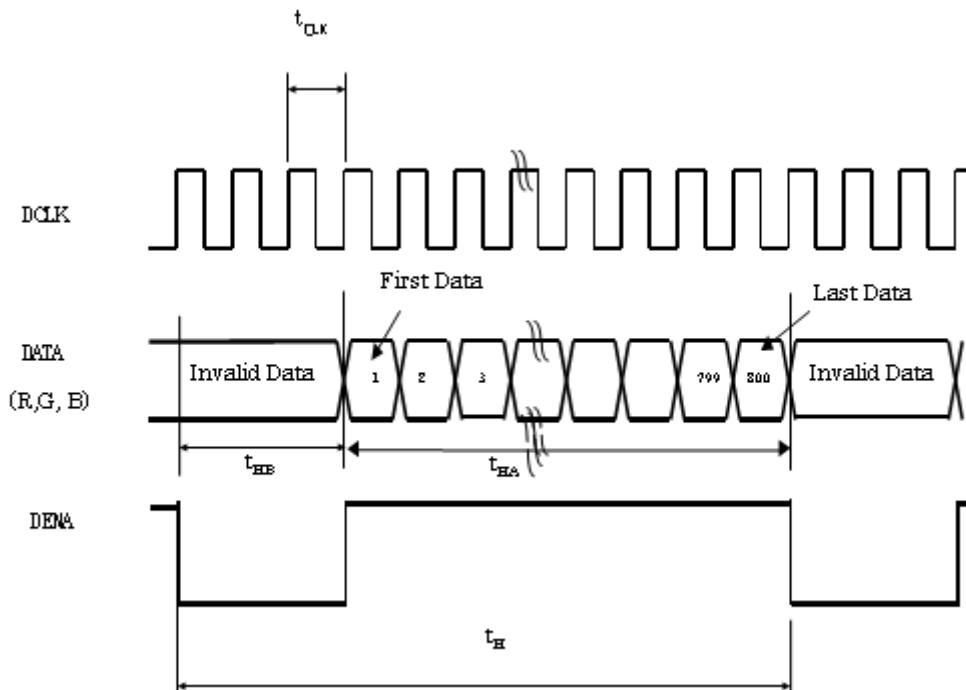

Vertical Timing:

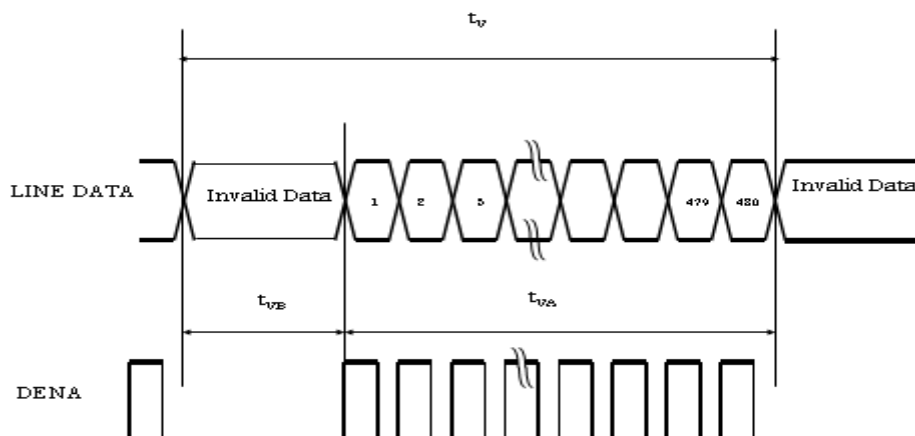

(2) LVDS Input Data Mapping

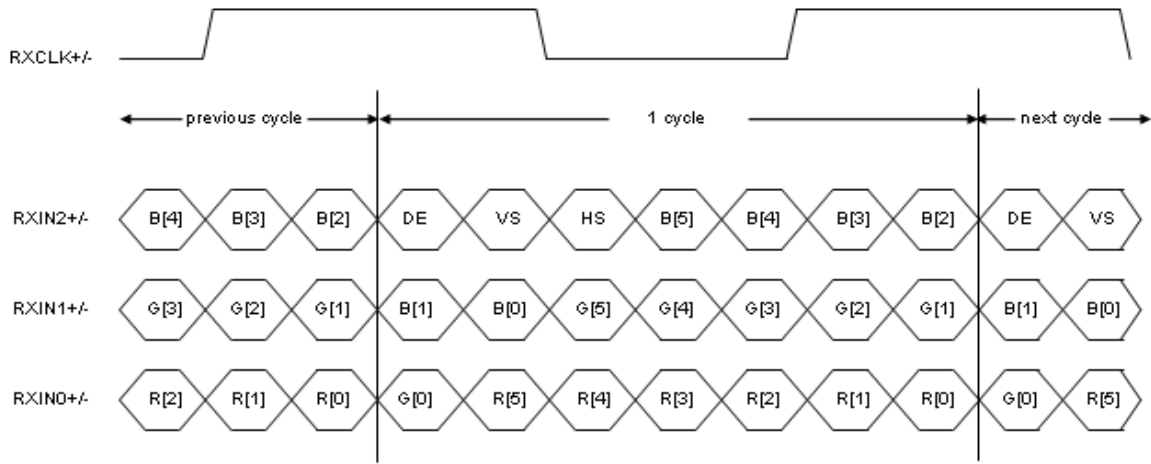

Note: R/G/B[7] are MSB and R/G/B[0] are LSB.

Only Confidential

6. BLOCK DIAGRAM

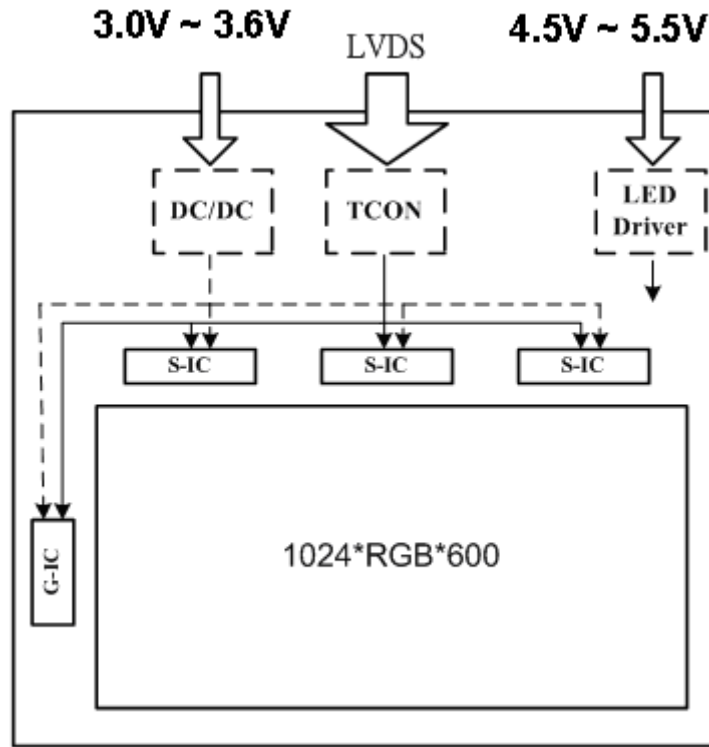

7. MECHANICAL DIMENSION

7.1 Front Side

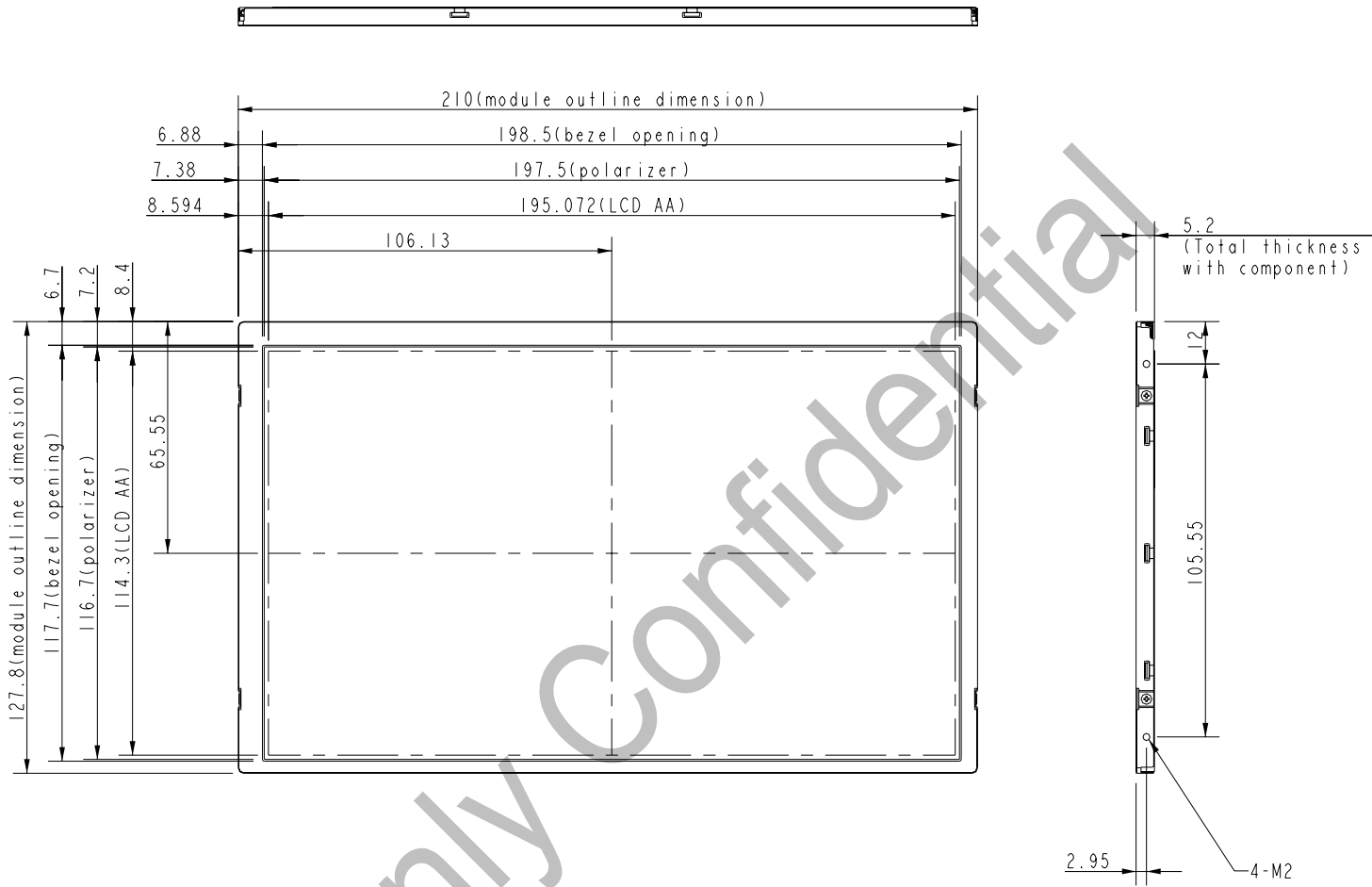

[Note]: Tolerance is $\pm 0.3\text{mm}$ unless noted

7.2 Rear Side

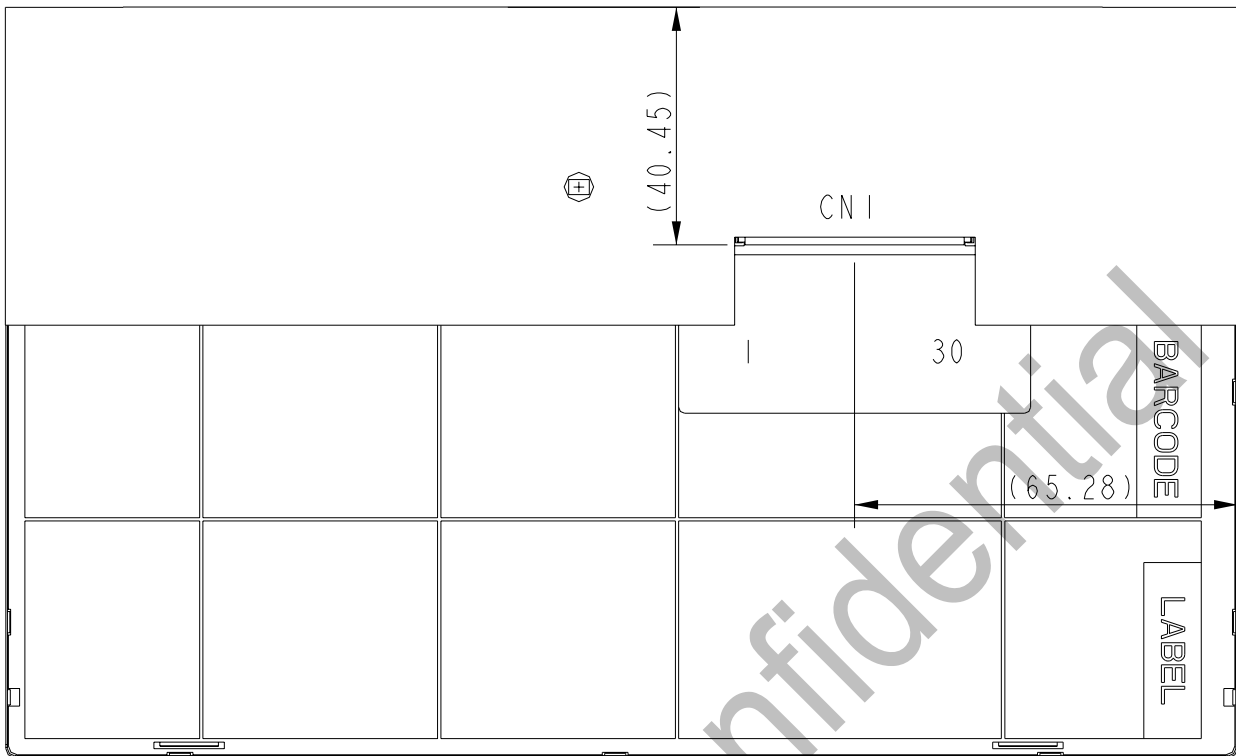

- [Note]:
1. Tolerance is ± 0.3 mm unless noted
 2. CN1: JAE FI-XB30SL-HF10
 3. SIDE MOUNT M2 SCREW TORQUE Max. 2.5 kgf*cm
 4. SIDE MOUNT M2 SCREW Length Max. 2.0 mm

8. OPTICAL CHARACTERISTICS

ITEM		SYMBOL	CONDITION	MIN.	TYP.	MAX.	UNIT	Remarks
Contrast Ratio		CR	Point-5	400	500	-	-	*1)*2)*3)
Luminance		Lw	Point-5	250	300		cd/m ²	*1)*3)
Luminance Uniformity		ΔL		70	80	-	%	*1)*3)
Response Time (White - Black)		Tr+ Tf	Point-5	-	20	35	ms	*1)*3)*5)
Viewing Angle	Horizontal	ψ	CR ≥ 10 Point-5	120	140	-	°	*1)*2)*4)
	Vertical	θ		100	120	-	°	*1)*2)*4)
Color Coordinate	White	Wx Wy	Point-5	0.273	0.313	0.353	-	*1)*3)
				0.289	0.329	0.369		
	Red	Rx Ry		0.564	0.604	0.644		
				0.305	0.345	0.385		
Green	Gx Gy	0.308	0.348	0.388				
		0.519	0.559	0.599				
Blue	Bx By	0.106	0.146	0.186				
		0.064	0.104	0.144				

[Note]:

*1) Measurement condition: 25°C ± 2°C, 60% ± 10% RH, under 10 Lux in the dark room. Measuring with BM-5A (TOPCON) under viewing angle 2°, V_{CC}=3.3V, V_{adj}=3.3V, Duty 100%, after lighting 10 mins.

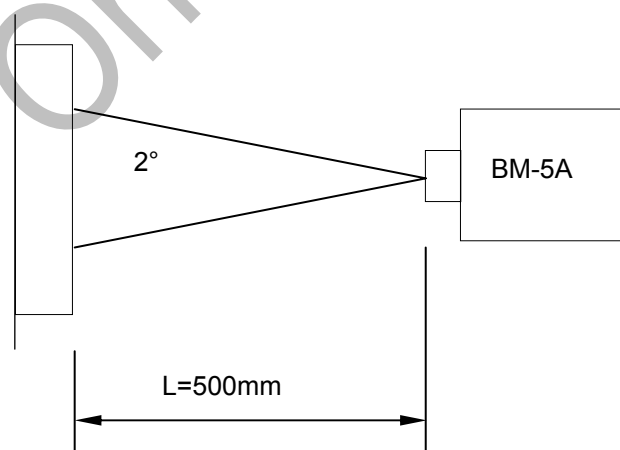

*2) Definition of contrast ratio:

Contrast Ratio (CR) = (White) Luminance of ON / (Black) Luminance of OFF

- *3) Definition of Luminance: Measuring white luminance on the point 5 as figure 8-1
- Definition of Luminance Uniformity: Measuring white luminance on the point1 to 9 as figure 8-1

$$\Delta L = [L(\text{Min})/L(\text{Max})] \times 100\%$$

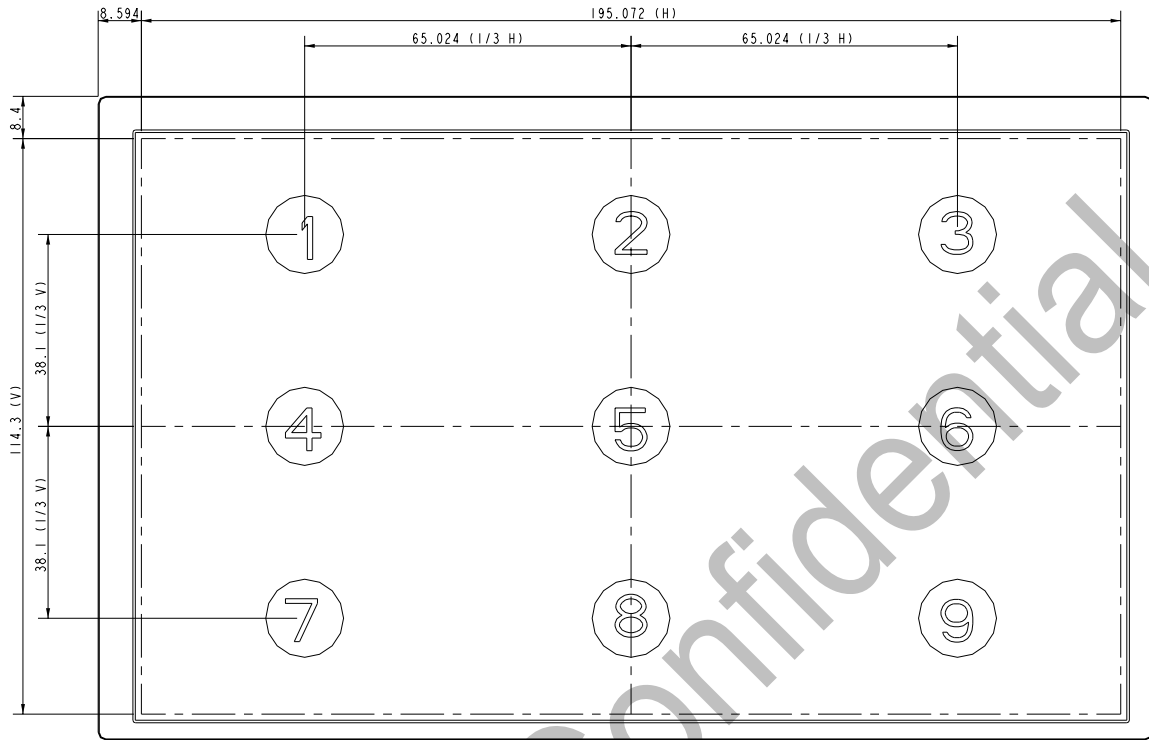

Fig. 8-1 Measuring point

- *4) Definition of Viewing Angle(θ, ψ):

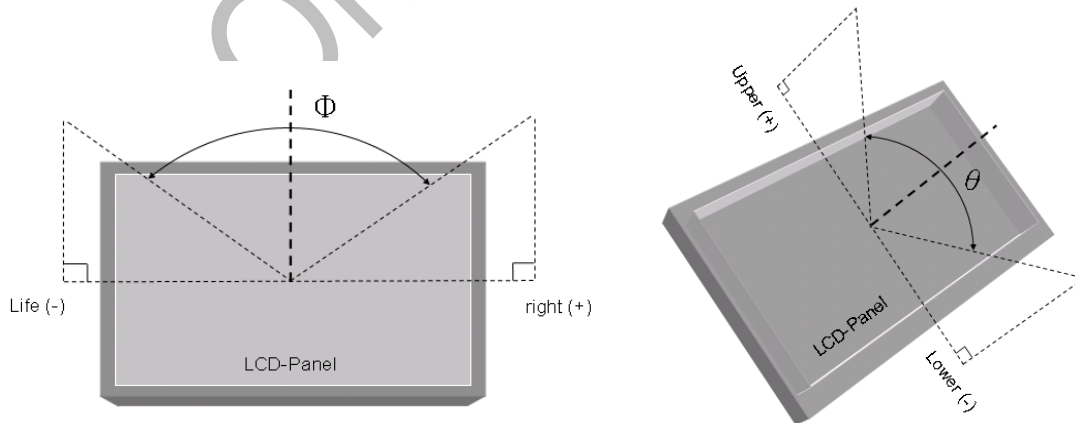

Fig. 8-2 Definition of Viewing Angle

*5) Definition of Response Time

The response time is defined as the time interval between the 10% and 90% amplitudes. Refer to the figure 8-3 as below.

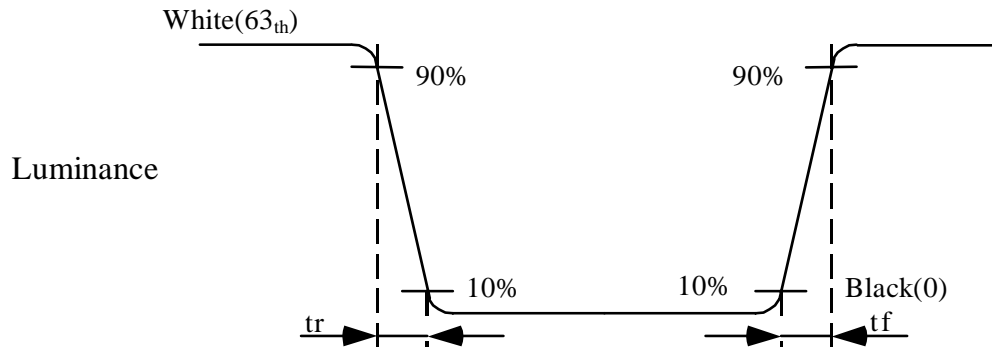

Fig. 8-3 Definition of Response Time

9. RELIABILITY TEST CONDITIONS

9.1 Temperature and Humidity

TEST ITEMS	CONDITIONS
High Temperature Operation	70° C ; 240 Hrs
High Temperature Storage	80° C ; 240 Hrs
High Temperature High Humidity Operation	60° C ; 90% RH ; 240 Hrs (No condensation)
Low Temperature Operation	-20° C ; 240Hrs
Low Temperature Storage	-30° C ; 240 Hrs
Thermal Shock	-30° C (0.5Hr)~80° C (0.5Hr) 200 CYCLE

9.2 Shock & Vibration

TEST ITEMS	CONDITIONS
SHOCK (NON-OPERATION)	<ul style="list-style-type: none"> ● Shock level: 980m/s²(equal to 100G). ● Waveform: half sinusoidal wave, 6ms. ● Number of shocks: one shock input in each direction of three mutually perpendicular axes for a total of three shock inputs.
VIBRATION (NON-OPERATION)	<ul style="list-style-type: none"> ● Frequency range: 8~33.3Hz ● Stroke : 1.3 mm ● Vibration: sinusoidal wave, perpendicular axis (both x,z axis: 2Hrs , and y axis: 4Hrs). ● Sweep: 2.9G, 33.3 Hz -400 Hz ● Cycle: 15 min

9.3. ESD Test

ITEM	CONDITION	NOTE
ESD	150pF , 330Ω , ±8KV&±15KV air test	【Note1】
	200pF , 0Ω , ±200V contact test	【Note2】

【Note】

【Note1】 LCD glass and metal bezel

【Note2】 IF connector pins

9.4 Judgment Standard

The judgment of the above test should be made as follow:

Pass: Normal display image with no obvious non-uniformity and no line defect.
Partial transformation of the module parts should be ignored.

Fail: No display image, obvious non-uniformity, or line defects.