

# MITSUBISHI IGBT MODULES CM100DY-24A

HIGH POWER SWITCHING USE

## CM100DY-24A



- IC ..... 100A
- VCES ..... 1200V
- Insulated Type
- 2-elements in a pack

## APPLICATION

AC drive inverters & Servo controls, etc

## OUTLINE DRAWING & CIRCUIT DIAGRAM

Dimensions in mm

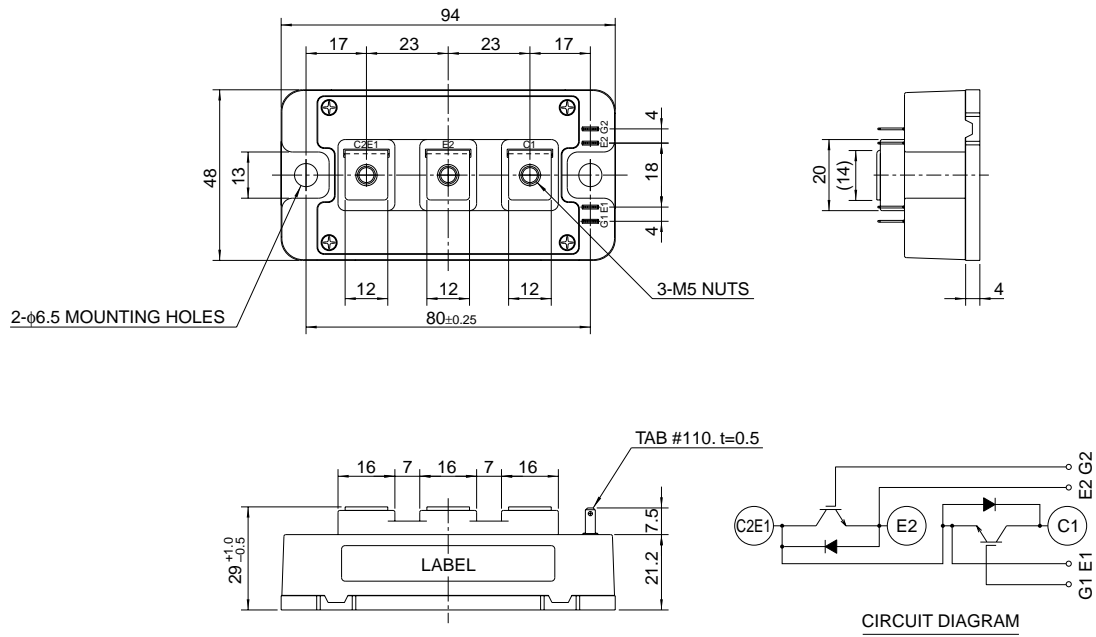

ABSOLUTE MAXIMUM RATINGS (T<sub>j</sub> = 25°C)

Symbol	Parameter	Conditions	Ratings	Unit
V <sub>CE</sub>	Collector-emitter voltage	G-E Short	1200	V
V <sub>GE</sub>	Gate-emitter voltage	C-E Short	±20	V
I <sub>C</sub>	Collector current	DC, T <sub>c</sub> = 84°C <sup>*1</sup>	100	A
I <sub>CM</sub>		Pulse (Note 2)	200	
I <sub>E</sub> (Note 1)	Emitter current		100	A
I <sub>EM</sub> (Note 1)		Pulse (Note 2)	200	
P <sub>C</sub> (Note 3)	Maximum collector dissipation	T <sub>c</sub> = 25°C <sup>*1</sup>	672	W
T <sub>j</sub>	Junction temperature		-40 ~ +150	°C
T <sub>stg</sub>	Storage temperature		-40 ~ +125	°C
V <sub>iso</sub>	Isolation voltage	Main terminal to base plate, AC 1 min.	2500	V
—	Torque strength	Main terminal M5	2.5 ~ 3.5	N • m
—		Mounting holes M6	3.5 ~ 4.5	
—	Weight	Typical value	310	g

ELECTRICAL CHARACTERISTICS (T<sub>j</sub> = 25°C)

Symbol	Parameter	Test conditions	Limits			Unit
			Min.	Typ.	Max.	
I <sub>CE</sub>	Collector cutoff current	V <sub>CE</sub> = V <sub>CE</sub> , V <sub>GE</sub> = 0V	—	—	1	mA
V <sub>GE(th)</sub>	Gate-emitter threshold voltage	I <sub>C</sub> = 10mA, V <sub>CE</sub> = 10V	6	7	8	V
I <sub>GE</sub>	Gate leakage current	V <sub>GE</sub> = V <sub>GE</sub> , V <sub>CE</sub> = 0V	—	—	0.5	μA
V <sub>CE(sat)</sub>	Collector-emitter saturation voltage	T <sub>j</sub> = 25°C	—	2.1	3.0	V
		T <sub>j</sub> = 125°C	—	2.4	—	
C <sub>ies</sub>	Input capacitance	V <sub>CE</sub> = 10V V <sub>GE</sub> = 0V	—	—	17.5	nF
C <sub>oes</sub>	Output capacitance		—	—	1.5	
C <sub>res</sub>	Reverse transfer capacitance		—	—	0.34	
Q <sub>G</sub>	Total gate charge	V <sub>CC</sub> = 600V, I <sub>C</sub> = 100A, V <sub>GE</sub> = 15V	—	500	—	nC
t <sub>d(on)</sub>	Turn-on delay time	V <sub>CC</sub> = 600V, I <sub>C</sub> = 100A V <sub>GE1</sub> = V <sub>GE2</sub> = 15V R <sub>G</sub> = 3.1Ω, Inductive load switching operation I <sub>E</sub> = 100A	—	—	100	ns
t <sub>r</sub>	Turn-on rise time		—	—	70	
t <sub>d(off)</sub>	Turn-off delay time		—	—	400	
t <sub>f</sub>	Turn-off fall time		—	—	350	
t <sub>rr</sub> (Note 1)	Reverse recovery time		—	—	150	
Q <sub>rr</sub> (Note 1)	Reverse recovery charge	—	5.0	—	μC	
V <sub>EC</sub> (Note 1)	Emitter-collector voltage	I <sub>E</sub> = 100A, V <sub>GE</sub> = 0V	—	—	3.8	V
R <sub>th(j-c)Q</sub>	Thermal resistance	IGBT part (1/2 module) <sup>*1</sup>	—	—	0.186	°C/W
R <sub>th(j-c)R</sub>		FWDi part (1/2 module) <sup>*1</sup>	—	—	0.34	
R <sub>th(c-f)</sub>	Contact thermal resistance	Case to fin, Thermal compound Applied (1/2 module) <sup>*1,*2</sup>	—	0.022	—	
R <sub>G</sub>	External gate resistance		3.1	—	42	Ω

\*1 : T<sub>c</sub>, T<sub>f</sub> measured point is just under the chips.

\*2 : Typical value is measured by using Shin-etsu Silicone "G-746".

Note 1. I<sub>E</sub>, V<sub>EC</sub>, t<sub>rr</sub> & Q<sub>rr</sub> represent characteristics of the anti-parallel, emitter to collector free-wheel diode (FWDi).

2. Pulse width and repetition rate should be such that the device junction temp. (T<sub>j</sub>) does not exceed T<sub>jmax</sub> rating.

3. Junction temperature (T<sub>j</sub>) should not increase beyond 150°C.

# CM100DY-24A

HIGH POWER SWITCHING USE

## PERFORMANCE CURVES

**OUTPUT CHARACTERISTICS (TYPICAL)**

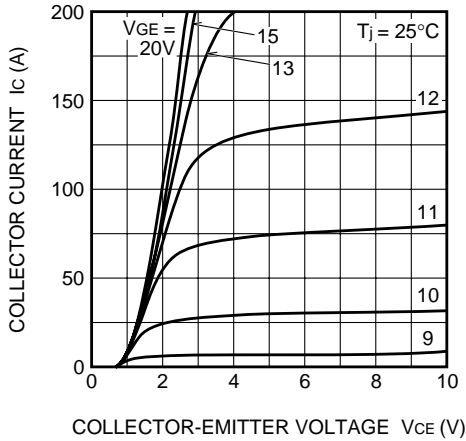

**COLLECTOR-EMITTER SATURATION VOLTAGE CHARACTERISTICS (TYPICAL)**

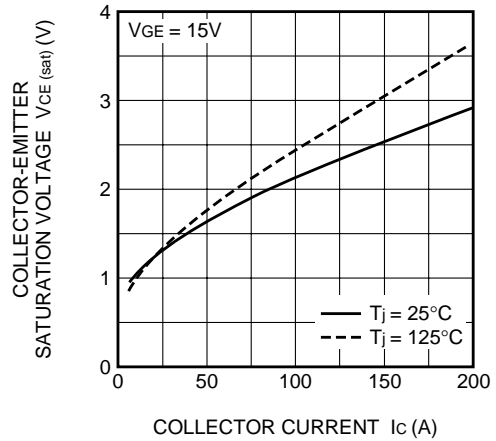

**COLLECTOR-EMITTER SATURATION VOLTAGE CHARACTERISTICS (TYPICAL)**

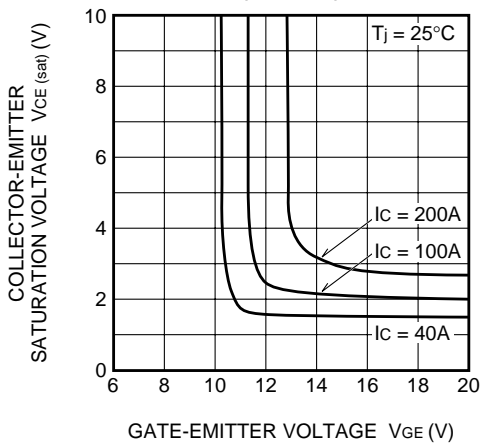

**FREE-WHEEL DIODE FORWARD CHARACTERISTICS (TYPICAL)**

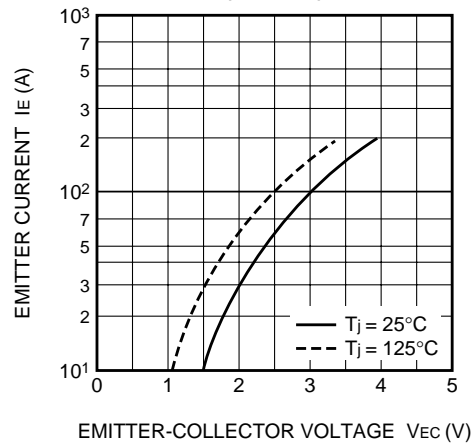

**CAPACITANCE-VCE CHARACTERISTICS (TYPICAL)**

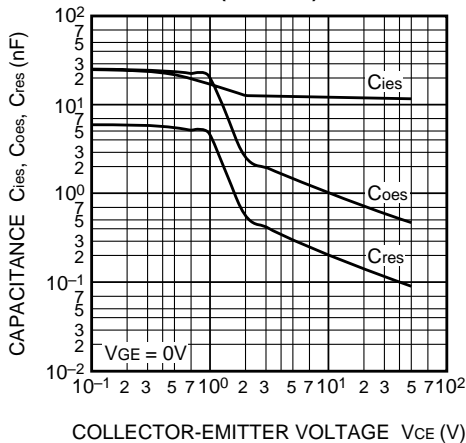

**HALF-BRIDGE SWITCHING CHARACTERISTICS (TYPICAL)**

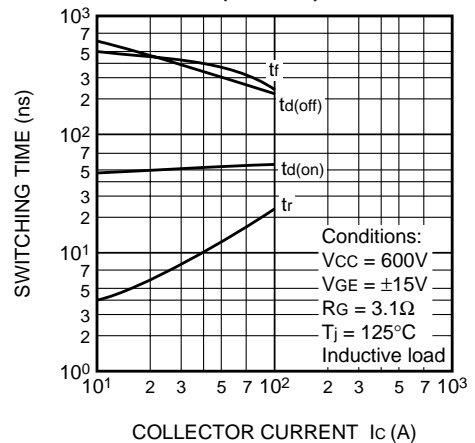

REVERSE RECOVERY CHARACTERISTICS OF FREE-WHEEL DIODE (TYPICAL)

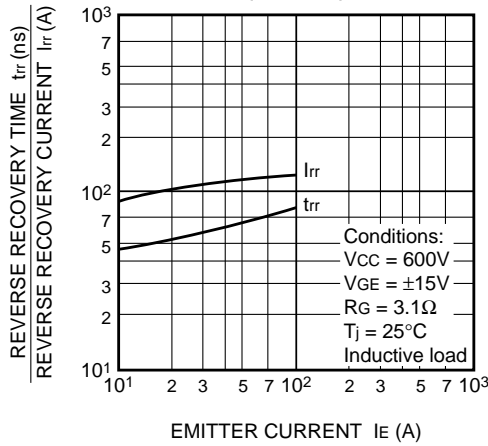

TRANSIENT THERMAL IMPEDANCE CHARACTERISTICS (IGBT part & FWDi part)

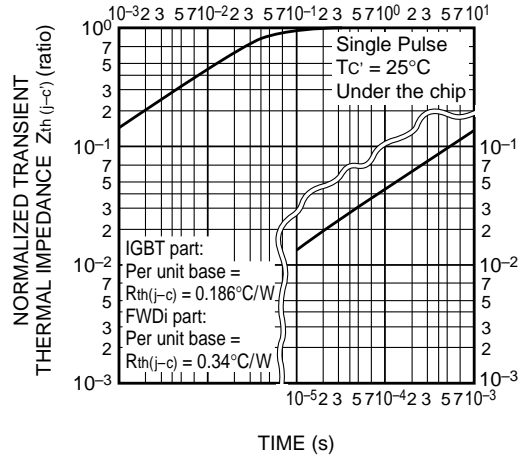

SWITCHING LOSS vs. COLLECTOR CURRENT (TYPICAL)

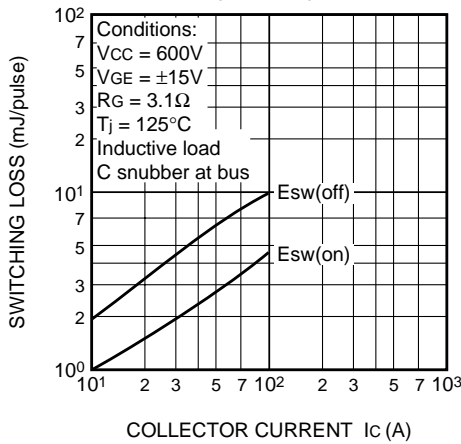

SWITCHING LOSS vs. GATE RESISTANCE (TYPICAL)

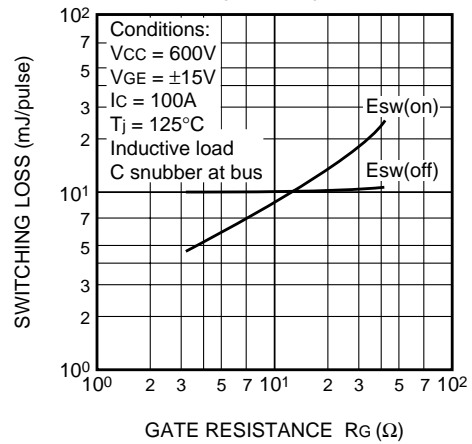

RECOVERY LOSS vs. IE (TYPICAL)

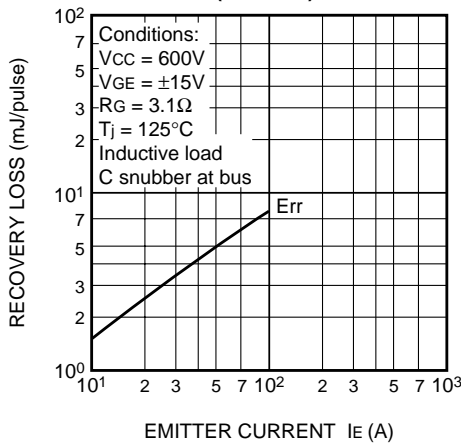

RECOVERY LOSS vs. GATE RESISTANCE (TYPICAL)

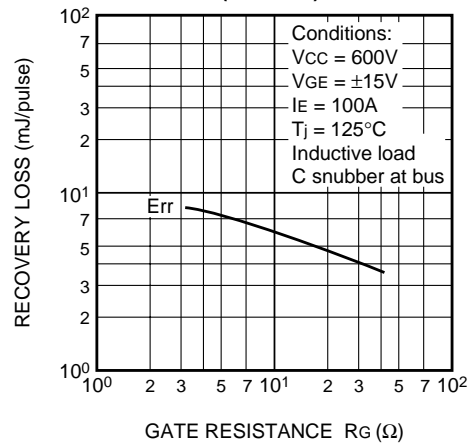

# CM100DY-24A

HIGH POWER SWITCHING USE

---

