

GENERAL DESCRIPTION

The CM1117A is a series of low dropout three-terminal regulators with a dropout of 1.1V at 600mA output current.

These products have been optimized for low voltage where transient response and minimum input voltage are critical. These CM1117A provide current limit and thermal shutdown. Its circuit includes a trimmed band-gap reference to assure output voltage accuracy to be within $\pm 1\%$. On-chip thermal shutdown provides protection against any combination of overload and ambient temperatures that would create excessive junction temperatures.

The CM1117A is available in 2.5V and 3.3V versions. The fixed versions integrate the adjust resistors. It is also available in an adjustable version which can set the output voltage with two external resistors.

APPLICATIONS

- ◆ DVD/CD-ROM
- ◆ USB Device
- ◆ Add-on Card
- ◆ DVD Player
- ◆ PC Motherboard

PIN CONFIGURATION

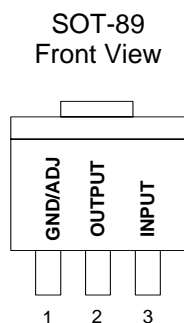

Figure 1. Package Types of CM1117A

FEATURES

- ◆ Low Dropout Voltage: 1.1V at 600mA output Current.
- ◆ Output Noise from 10Hz to 10KHz: 0.003%
- ◆ PSRR at $I_o = 300\text{mA}$ and $f = 120\text{Hz}$: 75dB
- ◆ Output Voltage Accuracy: $\pm 1\%$
- ◆ On-Chip Thermal Shutdown
- ◆ Maximum Quiescent Current: $I_{Q\text{MAX}} = 5\text{mA}$
- ◆ ESD (Human Body Model): 3.5KV
- ◆ Operation Junction Temperature -40 to 125°C

ORDERING INFORMATION

Package Type	Operating Temperature Range (T _A)	Output Voltage
SOT-89		
CM1117AKCM89	0°C ~ +85°C	2.5V
CM1117ASCM89	0°C ~ +85°C	3.3V
CM1117ACM89	0°C ~ +85°C	ADJ.
CM1117AGKCM89	0°C ~ +85°C	2.5V
CM1117AGSCM89	0°C ~ +85°C	3.3V
CM1117AGCM89	0°C ~ +85°C	ADJ.

*Note: G : Suffix for Pb Free Product

BLOCK DIAGRAM

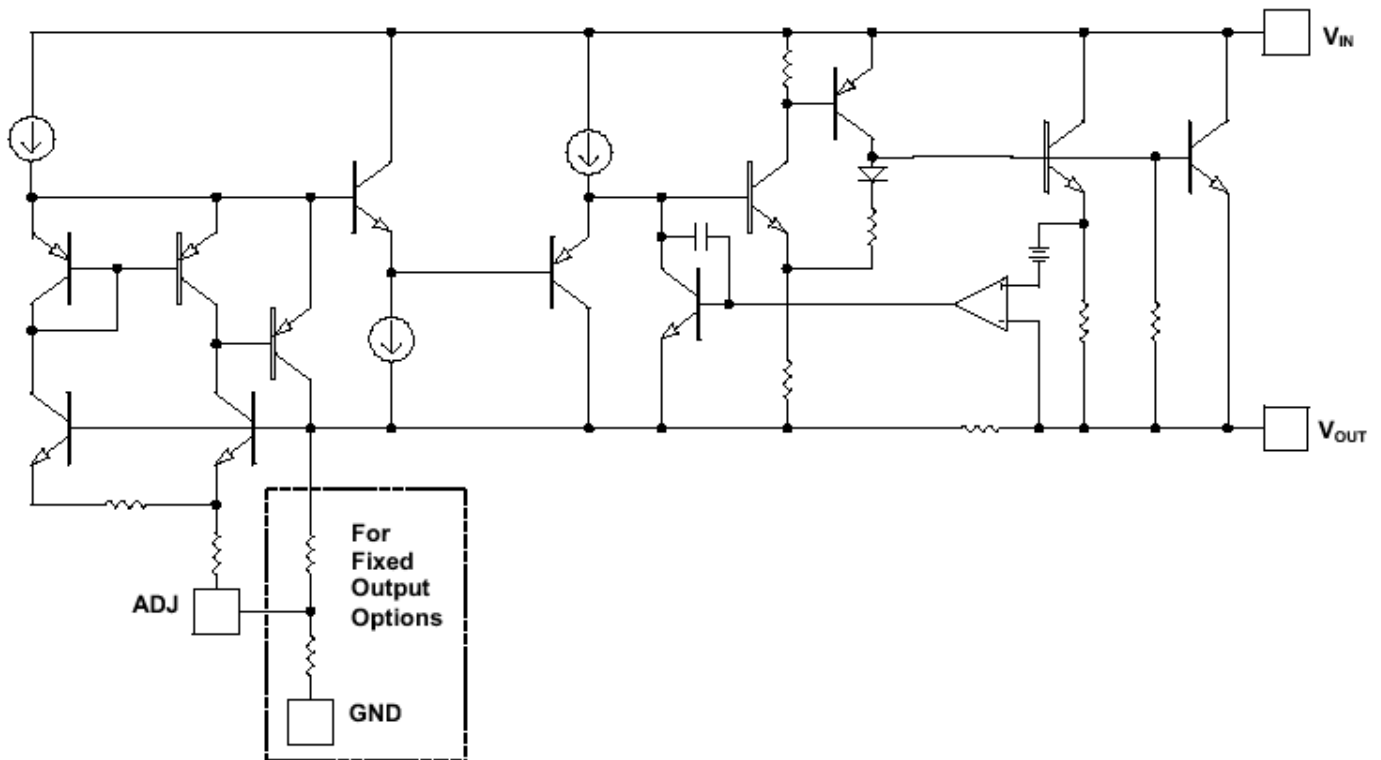

Figure 2. Functional Block Diagram of CM1117A

ABSOLUTE MAXIMUM RATINGS (Note 1)

Parameter	Symbol	Value	Unit
Input Voltage	V_{IN}	15	V
Operating Junction Temperature Range	T_J	150	°C
Storage Temperature Range	T_{STG}	-65 to 150	°C
Lead Temperature (Soldering, 10sec)	T_{LEAD}	300	°C
ESD (Human Body Model)	ESD	3500	V
ESD (Machine Model)	ESD	400	V

Note 1: Stresses greater than those listed under "Absolute Maximum Ratings" may cause permanent damage to the device. These are stress ratings only, and functional operation of the device at these or any other conditions beyond those indicated under "Recommended Operating Conditions" is not implied. Exposure to "Absolute Maximum Ratings" for extended periods may affect device reliability.

RESOMMENDED OPERATING CONDITIONS

Parameter	Symbol	Min.	Max	Units
Input Voltage	V_{IN}		12	V
Operating Junction Temperature Range	T_J	-40	125	°C
Storage Temperature Range	T_{STG}	-65	150	°C

ELECTRICAL CHARACTERISTICS

Operating Conditions: $V_{IN} \leq 10V$, $T_J = 25^\circ C$, unless otherwise specified. ($P \leq$ maximum power dissipation) Limit appearing in Boldface type apply over the entire junction temperature range for operation, $-40^\circ C$ to $125^\circ C$

Parameter	Symbol	Test Conditions	CM1117A			Unit
			Min.	Typ.	Max.	
Reference Voltage	V_{REF}	CM1117A-ADJ $I_{OUT} = 10mA$, $V_{IN} = V_{OUT} = 2V$, $T_J = 25^\circ C$ $10mA \leq I_{OUT} \leq 600mA$, $1.4V \leq V_{IN} - V_{OUT} \leq 8V$ $P \leq$ maximum power dissipation	1.238	1.250	1.262	V
Output Voltage	V_{OUT}	CM1117A-2.5 $I_{OUT} = 10mA$, $V_{IN} = 4.5V$, $T_J = 25^\circ C$ $10mA \leq I_{OUT} \leq 600mA$, $3.9V \leq V_{IN} \leq 10V$	2.475	2.5	2.525	V
		CM1117A-3.3 $I_{OUT} = 10mA$, $V_{IN} = 5.0V$, $T_J = 25^\circ C$ $10mA \leq I_{OUT} \leq 600mA$, $4.75V \leq V_{IN} \leq 10V$	2.450	2.5	2.550	V
Line Regulator	ΔV_{OUT}	CM1117A-ADJ $I_{OUT} = 10mA$, $1.5V \leq V_{IN} - V_{OUT} \leq 10V$		0.035	0.2	%
		CM1117A-3.3 $I_{OUT} = 10mA$, $1.5V \leq V_{IN} - V_{OUT} \leq 10V$		1.0	6.0	mV
		CM1117A-2.5 $I_{OUT} = 10mA$, $1.5V \leq V_{IN} - V_{OUT} \leq 10V$		1.0	6.0	mV
Load Regulation	ΔV_{OUT}	CM1117A-ADJ ($V_{IN} = V_{OUT}$) = 2V, $10mA \leq I_{OUT} \leq 600mA$		0.20	0.40	%
		CM1117A-3.3 ($V_{IN} = V_{OUT}$) = 2V, $10mA \leq I_{OUT} \leq 600mA$		1.0	10.0	mV
		CM1117A-2.5 ($V_{IN} = V_{OUT}$) = 2V, $10mA \leq I_{OUT} \leq 600mA$		1.0	10.0	mV
Dropout Voltage		$\Delta V_{REF} = 1\%$, $I_{OUT} = 0.6A$		1.1	1.3	V
Current Limit	I_{LIMIT}	($V_{IN} - V_{OUT}$) = 2V	0.75	0.9		A
Adjust Pin Current				60	120	μA
Adjust Pin Current Change		$1.4V \leq (V_{IN} - V_{OUT}) \leq 10V$, $10mA \leq I_{OUT} \leq 600mA$		0.2	5.0	
Minimum Load Current		$1.5V \leq (V_{IN} - V_{OUT}) \leq 10V$ (ADJ only)		1.7	5.0	mA
Quiescent Current		$V_{IN} = V_{OUT} + 1.25V$			5.0	mA
Ripple Rejection		$f = 120Hz$, $C_{OUT} = 22 \mu F$ Tantalum ($V_{IN} - V_{OUT}$) = 3V, $I_{OUT} = 300mA$	60	75		dB
Temperature Stability				0.5		%
Long-Term Stability		$T_A = 125^\circ C$, 1000hrs.		0.3		%
RMS Output Noise (% of V_{OUT})		$T_A = 25^\circ C$, $10Hz \leq f \leq 10KHz$		0.003		%
Thermal Shutdown		Junction Temperature		150		$^\circ C$
Thermal Shutdown Hysteresis				25		$^\circ C$
Thermal Resistance (Junction to case)	θ_{JC}	SOT-89		100		$^\circ C/W$
		SOT-223		33		$^\circ C/W$

APPLICATION CIRCUIT

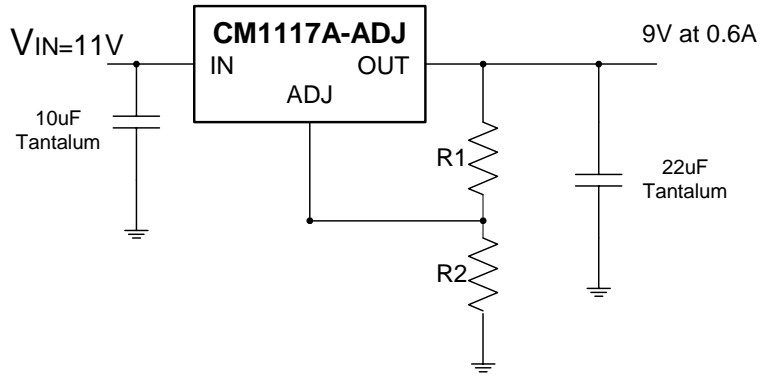

$$V_{OUT} = V_{REF} * (1+R2/R1) + I_{ADJ} * R2$$

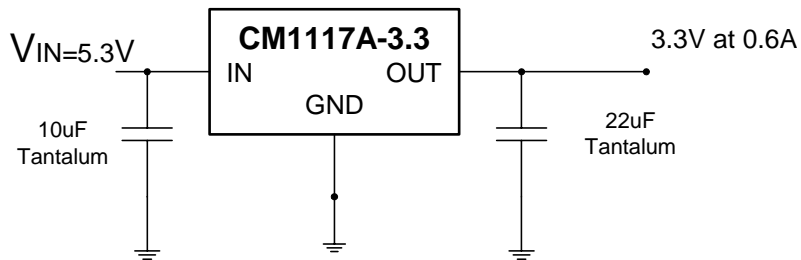

Figure 3. Typical Applications of CM1117A

TYPICAL PERFORMANCE CHARACTERISTICS

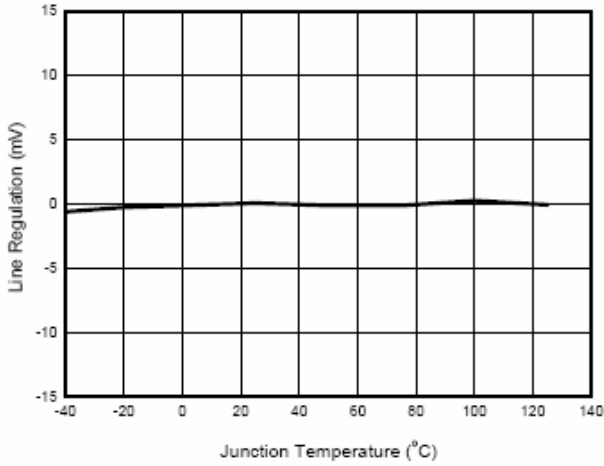

Figure 4. Line Regulation vs. Junction Temperature

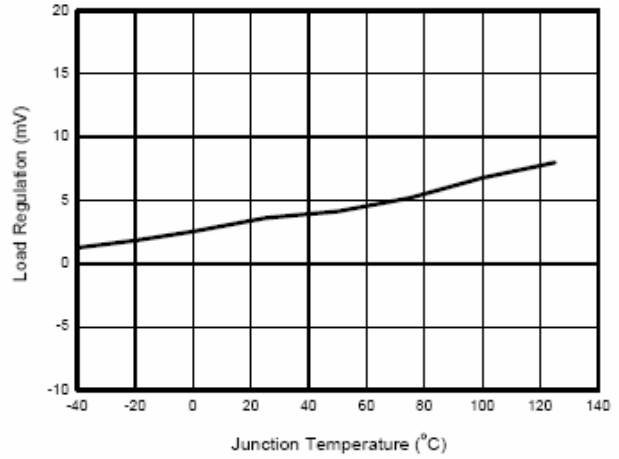

Figure 5. Load Regulation vs. Junction Temperature

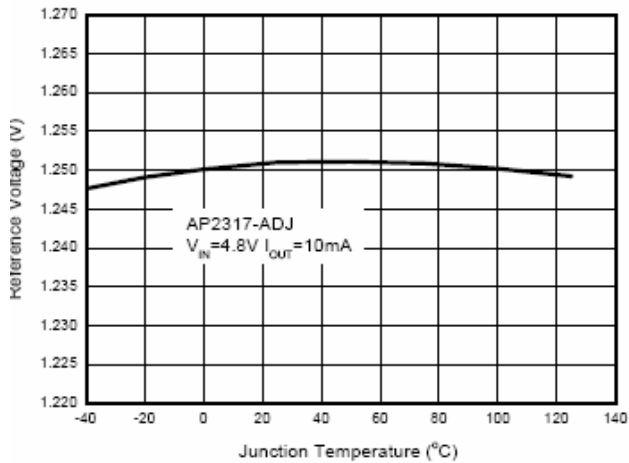

Figure 6. Reference Voltage vs. Junction Temperature

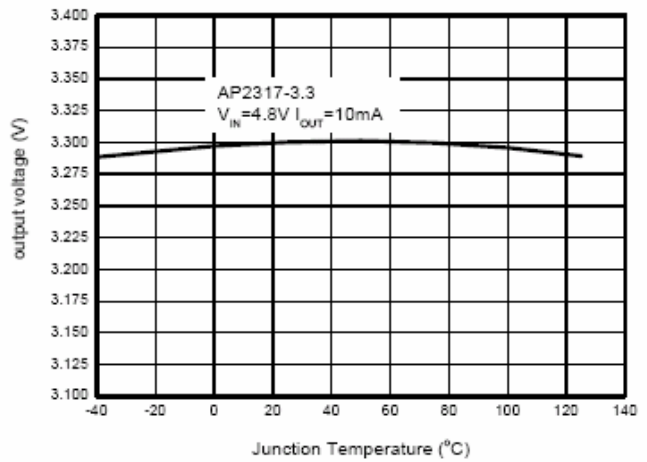

Figure 7. Output Voltage vs. Junction Temperature

TYPICAL PERFORMANCE CHARACTERISTICS (CONTINUED)

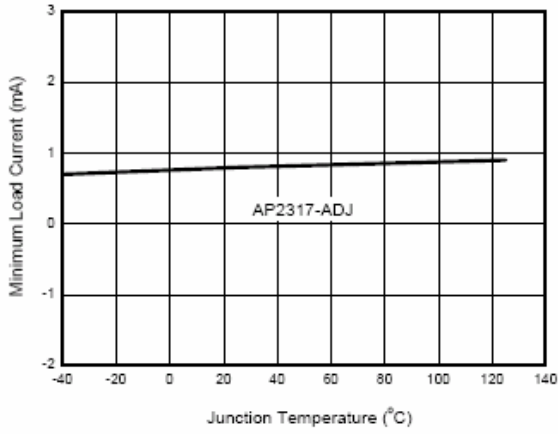

Figure 8. Minimum Load Current vs. Junction Temperature

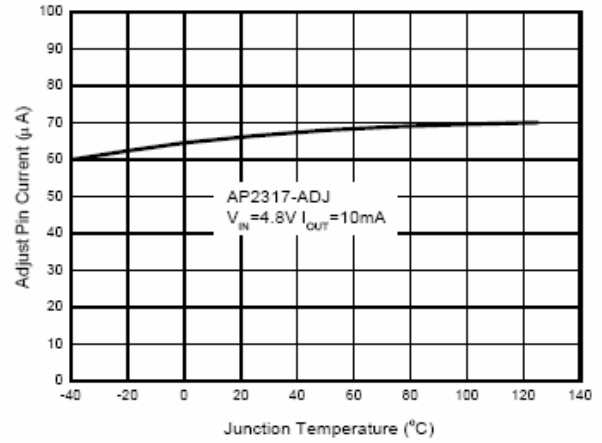

Figure 9. Adjust Pin Current vs. Junction Temperature

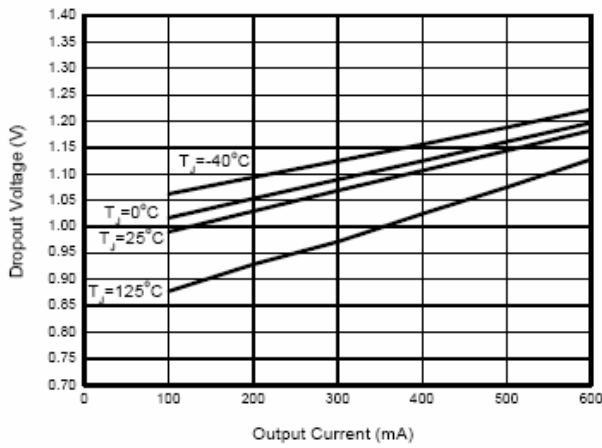

Figure 10. Dropout Voltage vs. Output Current

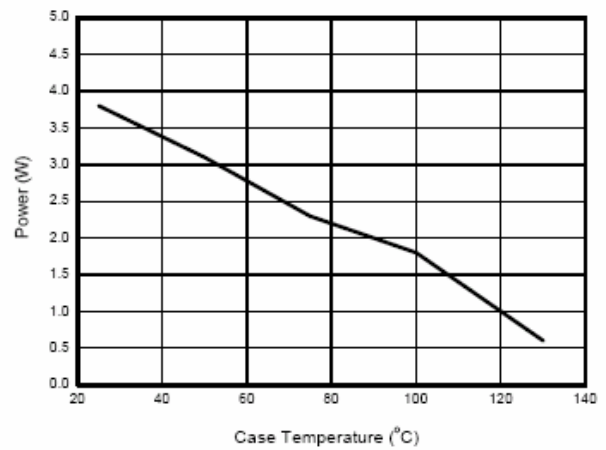
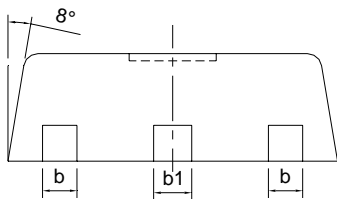
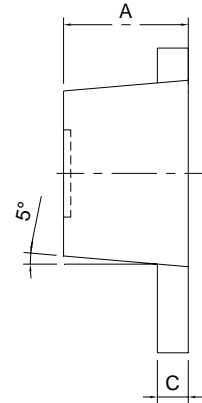
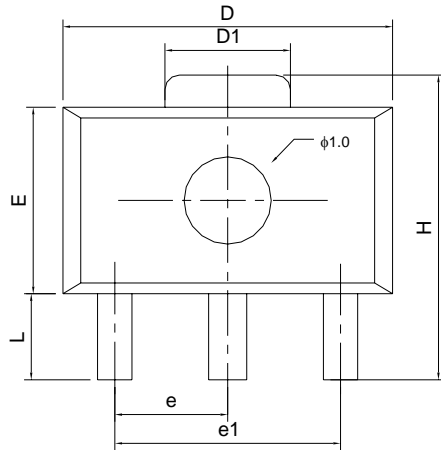

Figure 11. Maximum Power Dissipation

PACKAGE DIMENSION

SOT-89 (M89)



SYMBOLS	DIMENSIONS IN MILLIMETERS			DIMENSIONS IN INCHES		
	MIN	NOM	MAX	MIN	NOM	MAX
A	1.40	1.60	1.60	0.065	0.059	0.063
L	0.80	---	1.20	0.031	---	0.047
b	0.36	0.42	0.48	0.014	0.016	0.018
b1	0.41	0.47	0.53	0.016	0.018	0.020
c	0.38	0.40	0.43	0.014	0.015	0.017
D	4.40	4.60	4.60	0.173	0.177	0.181
D1	1.40	1.60	1.75	0.055	0.062	0.069
H	3.94	---	4.25	0.155	---	0.167
E	2.40	2.60	2.60	0.094	0.099	0.102
e1	2.90	3.00	3.10	0.114	0.118	0.122
e	1.45	1.50	1.55	0.057	0.059	0.061

IMPORTANT NOTICE

Champion Microelectronic Corporation (CMC) reserves the right to make changes to its products or to discontinue any integrated circuit product or service without notice, and advises its customers to obtain the latest version of relevant information to verify, before placing orders, that the information being relied on is current.

A few applications using integrated circuit products may involve potential risks of death, personal injury, or severe property or environmental damage. CMC integrated circuit products are not designed, intended, authorized, or warranted to be suitable for use in life-support applications, devices or systems or other critical applications. Use of CMC products in such applications is understood to be fully at the risk of the customer. In order to minimize risks associated with the customer's applications, the customer should provide adequate design and operating safeguards.

HsinChu Headquarter

5F, No. 11, Park Avenue II,
Science-Based Industrial Park,
HsinChu City, Taiwan
TEL: +886-3-567 9979
FAX: +886-3-567 9909

Sales & Marketing

7F-6, No.32, Sec. 1, Chenggong Rd., Nangang
District, Taipei City 115, Taiwan
TEL: +886-2-2788 0558
FAX: +886-2-2788 2985
