

6 Channel EMI Filter Array with ESD Protection

Features

- Functionally and pin compatible with CSPEMI306A device
- *OptiGuard*[™] coated for improved reliability at assembly
- Six channels of EMI filtering for data ports
- Pi-style EMI filters in a capacitor-resistor-capacitor (C-R-C) network
- 40dB absolute attenuation (typical) at 1 GHz
- 35dB attenuation (typical) at 1 GHz relative to pass band
- ±15kV ESD protection on each channel (IEC 61000-4-2 Level 4, contact discharge)
- ±30kV ESD protection on each channel (HBM)
- 15-bump, 2.960mm X 1.330mm footprint Chip Scale Package (CSP)
- Chip Scale Package features extremely low lead inductance for optimum filter and ESD performance
- Lead-free version available

Applications

- EMI filtering and ESD protection for both data and I/O ports
- Wireless Handsets
- Handheld PCs / PDAs
- MP3 Players
- Notebooks
- Desktop PCs

Product Description

The CM1400-03 is a six channel low-pass filter array that reduces EMI/RFI emissions while at the same time providing ESD protection. It is used on data ports on mobile devices. To reduce EMI/RFI emissions, the CM1400-03 integrates a pi-style filter (C-R-C) for each of the 6 channels. Each high quality filter provides greater than 30dB attenuation in the 800-2700 MHz range relative to the pass band attenuation. These pi-style filters also support bidirectional filtering, controlling EMI both to and from a data port connector.

In addition, the CM1400-03 provides a very high level of protection for sensitive electronic components that may be subjected to electrostatic discharge (ESD). The input pins are designed and characterized to safely dissipate ESD strikes of ±15kV, exceeding the maximum requirement of the IEC 61000-4-2 international standard. Using the MIL-STD-883 (Method 3015) specification for Human Body Model (HBM) ESD, the device provides protection for contact discharges to greater than ±30kV.

The CM1400-03 is particularly well suited for portable electronics (e.g., cellular telephones, PDAs, notebook computers) because of its small package footprint and low weight.

The CM1400-03 incorporates *OptiGuard*[™] coating which results in improved reliability at assembly. The CM1400-03 is available in a space-saving, low-profile chip scale package with optional lead-free finishing.

Electrical Schematic

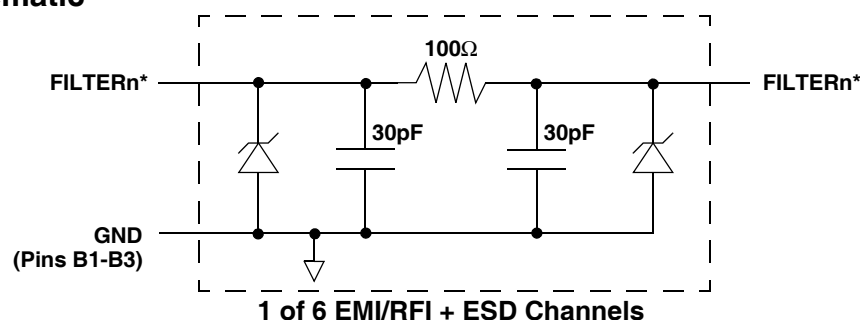

* See Package/Pinout Diagram for expanded pin information.

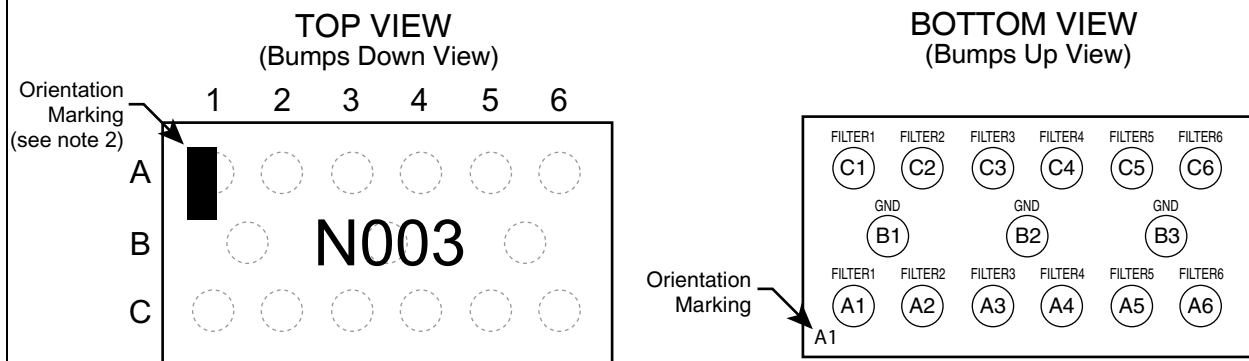
PACKAGE / PINOUT DIAGRAMS

CM1400-03CS/CP
CSP Package

Notes:

- 1) These drawings are not to scale.
- 2) Lead-free devices are specified by using a "+" character for the top side orientation mark.

PIN DESCRIPTIONS

PIN(s)	NAME	DESCRIPTION
A1	FILTER1	Filter Channel 1
A2	FILTER2	Filter Channel 2
A3	FILTER3	Filter Channel 3
A4	FILTER4	Filter Channel 4
A5	FILTER5	Filter Channel 5
A6	FILTER6	Filter Channel 6
B1-B3	GND	Device Ground
C1	FILTER1	Filter Channel 1
C2	FILTER2	Filter Channel 2
C3	FILTER3	Filter Channel 3
C4	FILTER4	Filter Channel 4
C5	FILTER5	Filter Channel 5
C6	FILTER6	Filter Channel 6

Ordering Information
PART NUMBERING INFORMATION

Pins	Package	Standard Finish		Lead-free Finish ²	
		Ordering Part Number ¹	Part Marking	Ordering Part Number ¹	Part Marking
15	CSP	CM1400-03CS	N003	CM1400-03CP	N003

Note 1: Parts are shipped in Tape & Reel form unless otherwise specified.

Note 2: Lead-free devices are specified by using a "+" character for the top side orientation mark.

Specifications

ABSOLUTE MAXIMUM RATINGS

PARAMETER	RATING	UNITS
Storage Temperature Range	-65 to +150	°C
DC Power per Resistor	100	mW
DC Package Power Rating	600	mW

STANDARD OPERATING CONDITIONS

PARAMETER	RATING	UNITS
Operating Temperature Range	-40 to +85	°C

ELECTRICAL OPERATING CHARACTERISTICS (SEE NOTE1)

SYMBOL	PARAMETER	CONDITIONS	MIN	TYP	MAX	UNITS
R	Resistance		80	100	120	Ω
C	Capacitance	At 2.5V DC	24	30	36	pF
TCR	Temperature Coefficient of Resistance			1200		ppm/°C
TCC	Temperature Coefficient of Capacitance	At 2.5V DC		-300		ppm/°C
V _{DIODE}	Diode Voltage (reverse bias)	I _{DIODE} =10μA		6.0		V
I _{LEAK}	Diode Leakage Current (reverse bias)	V _{DIODE} =3.3V			100	nA
V _{SIG}	Signal Voltage Positive Clamp Negative Clamp	I _{LOAD} = 10mA	5.6 -1.5	6.8 -0.8	9.0 -0.4	V V
V _{ESD}	In-system ESD Withstand Voltage a) Human Body Model, MIL-STD-883, Method 3015 b) Contact Discharge per IEC 61000-4-2 Level 4	Notes 2 and 4	±30 ±15			kV kV
V _{CL}	Clamping Voltage during ESD Discharge MIL-STD-883 (Method 3015), 8kV Positive Transients Negative Transients	Notes 2, 3 and 4		+10 -5		V V
f _C	Cut-off Frequency Z _{SOURCE} =50Ω, Z _{LOAD} =50Ω	R=100Ω, C=30pF		58		MHz

Note 1: T_A=25°C unless otherwise specified.

Note 2: ESD applied to input and output pins with respect to GND, one at a time.

Note 3: Clamping voltage is measured at the opposite side of the EMI filter to the ESD pin. For example, if ESD is applied to Pin A1, then clamping voltage is measured at Pin C1.

Note 4: These parameters are guaranteed by design and characterization.

Performance Information

Typical Filter Performance (T_A=25°C, DC Bias=0V, 50 Ohm Environment)

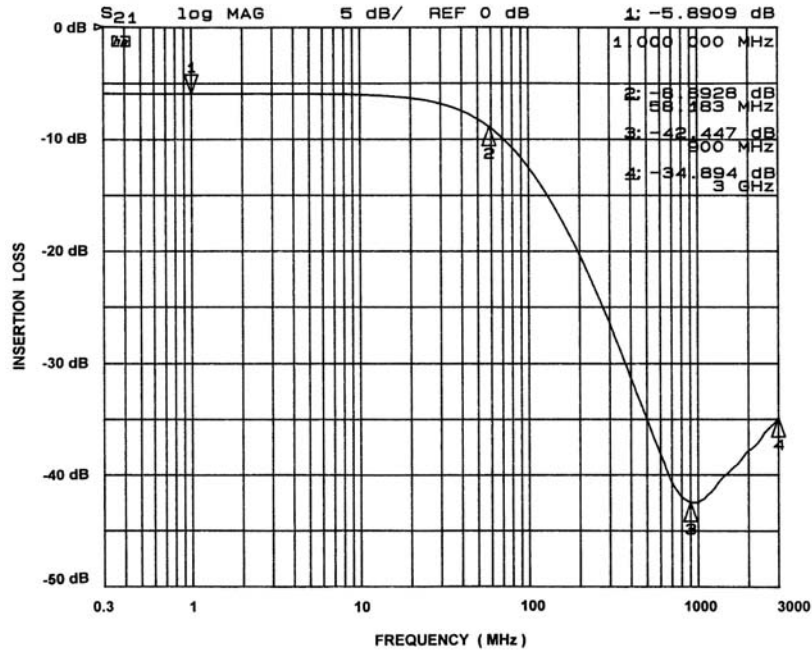

Figure 1. Insertion Loss vs. Frequency (A1-C1 to GND B2)

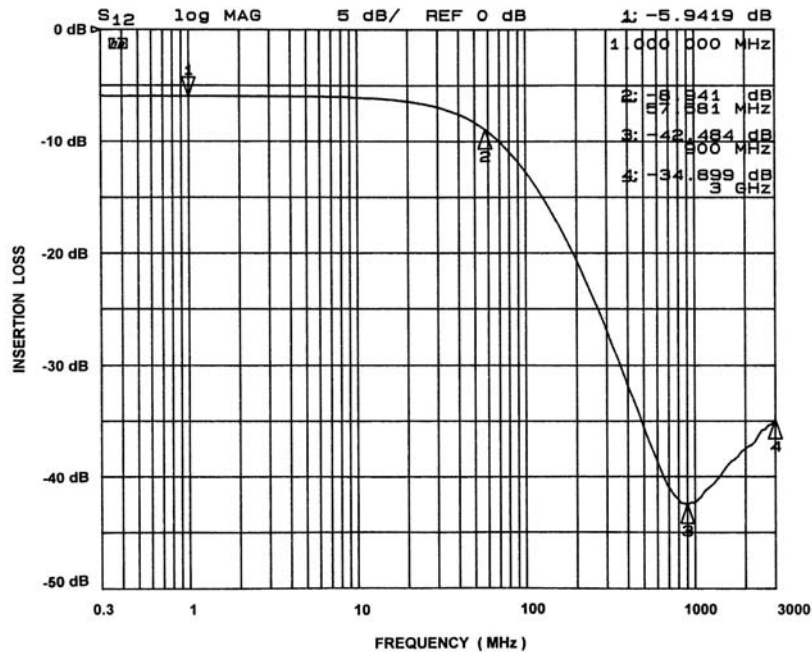

Figure 2. Insertion Loss vs. Frequency (A2-C2 to GND B2)

Performance Information (cont'd)

Typical Filter Performance (T_A=25°C, DC Bias=0V, 50 Ohm Environment)

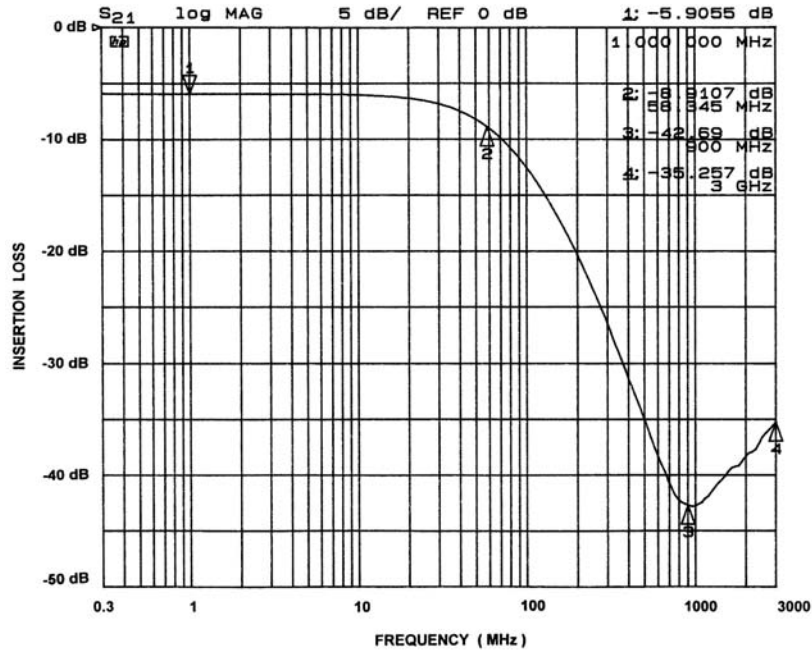

Figure 3. Insertion Loss vs. Frequency (A3-C3 to GND B2)

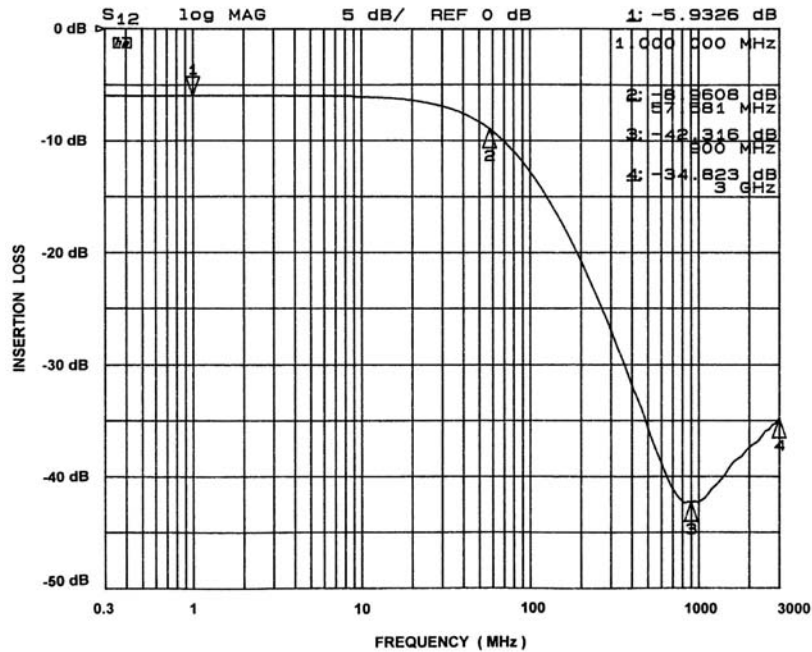

Figure 4. Insertion Loss vs. Frequency (A4-C4 to GND B2)

Performance Information (cont'd)

Typical Filter Performance (T_A=25°C, DC Bias=0V, 50 Ohm Environment)

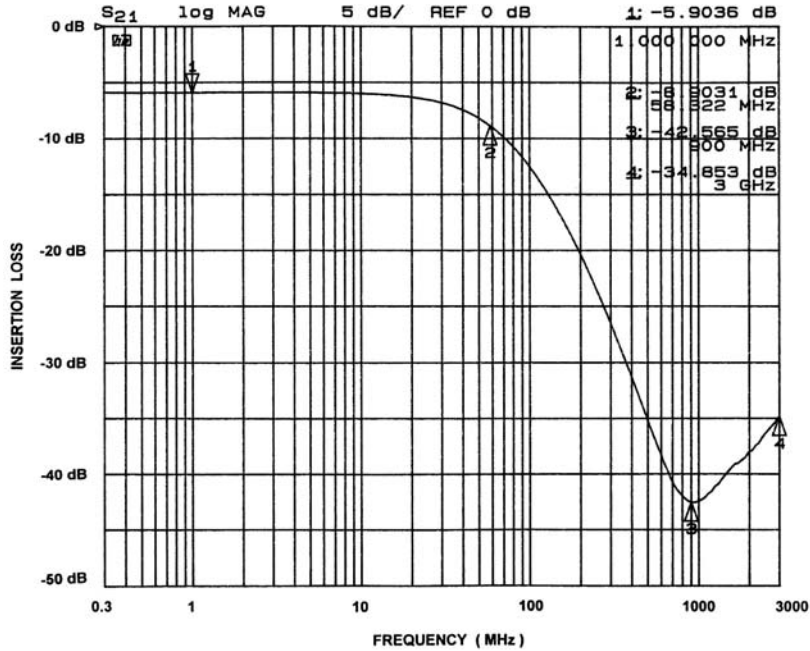

Figure 5. Insertion Loss vs. Frequency (A5-C5 to GND B2)

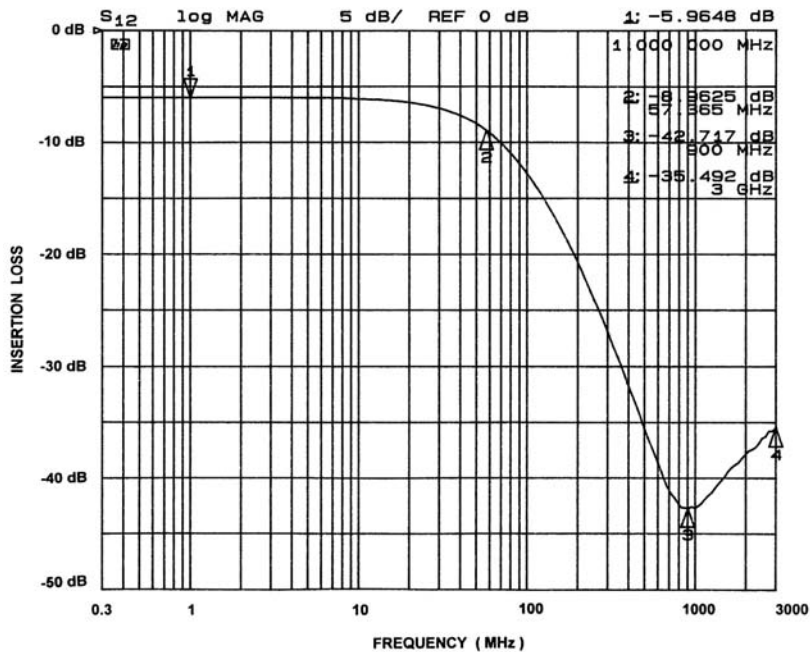

Figure 6. Insertion Loss vs. Frequency (A6-C6 to GND B2)

Performance Information (cont'd)

Typical Filter Performance ($T_A=25^\circ\text{C}$, DC Bias=0V, 50 Ohm Environment)

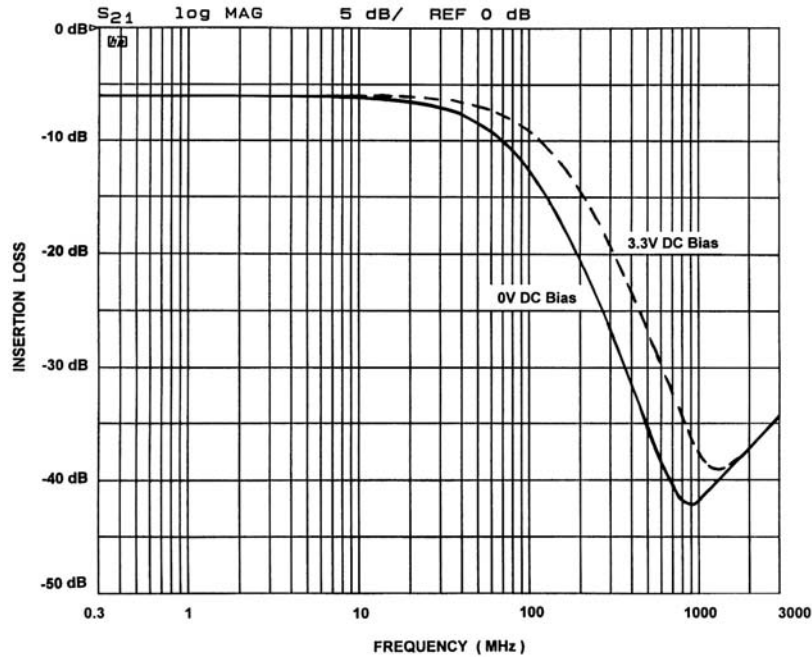

Figure 7. Comparison of Filter Response Curves for CM1400-03 with DC Bias

Performance Information (cont'd)

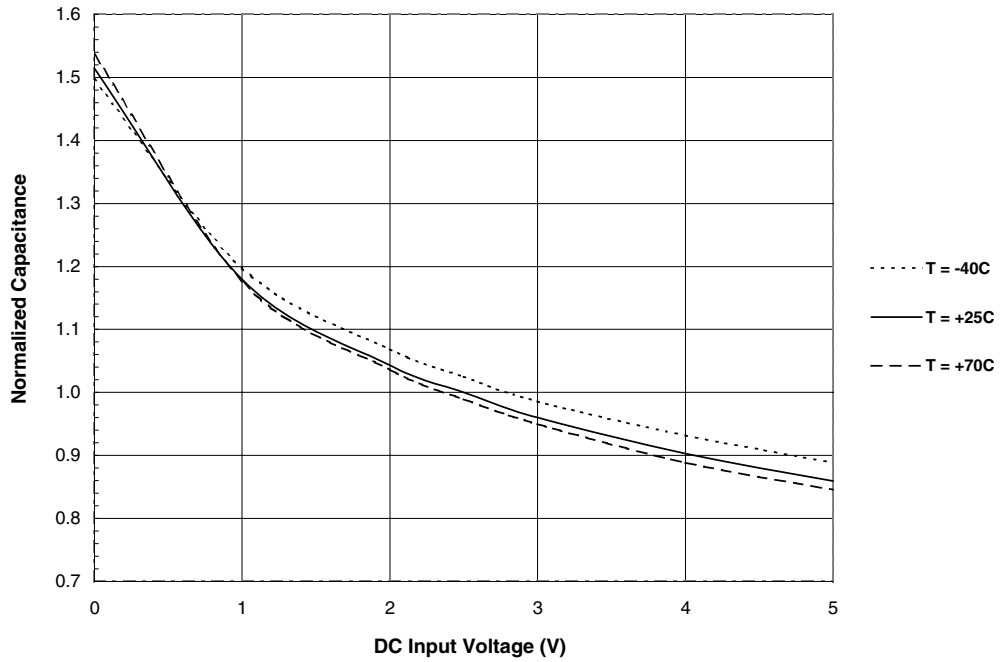

Figure 8. Filter Capacitance vs. Input Voltage over Temperature (normalized to capacitance at 2.5VDC and 25°C)

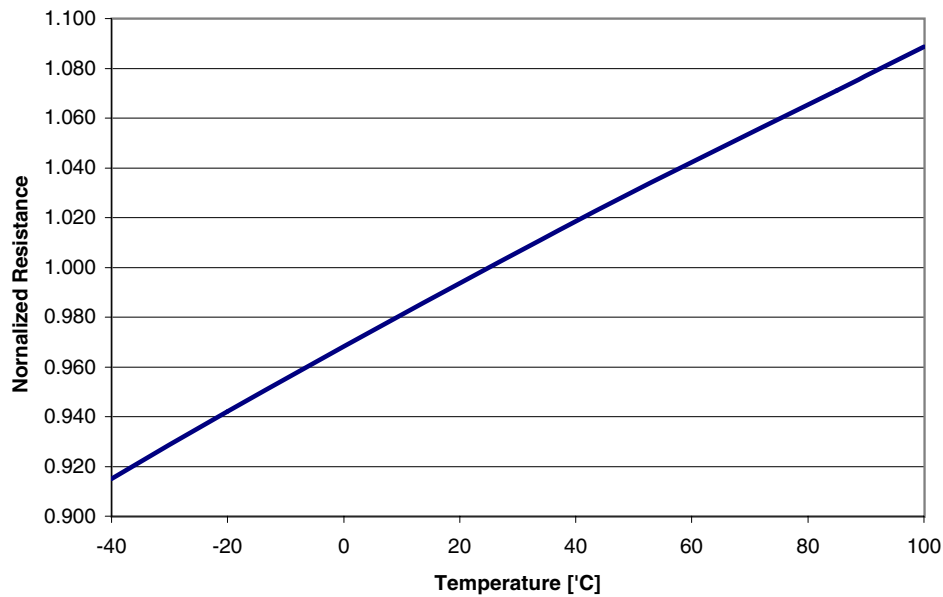

Figure 9. Resistance vs. Temperature (normalized to resistance at 25°C)

Application Information

Refer to Application Note AP-217, "The Chip Scale Package", for a detailed description of Chip Scale Packages offered by California Micro Devices.

PRINTED CIRCUIT BOARD RECOMMENDATIONS

PARAMETER	VALUE
Pad Size on PCB	0.275mm
Pad Shape	Round
Pad Definition	Non-Solder Mask defined pads
Solder Mask Opening	0.325mm Round
Solder Stencil Thickness	0.125mm - 0.150mm
Solder Stencil Aperture Opening (laser cut, 5% tapered walls)	0.330mm Round
Solder Flux Ratio	50/50 by volume
Solder Paste Type	No Clean
Pad Protective Finish	OSP (Entek Cu Plus 106A)
Tolerance — Edge To Corner Ball	$\pm 50\mu\text{m}$
Solder Ball Side Coplanarity	$\pm 20\mu\text{m}$
Maximum Dwell Time Above Liquidous	60 seconds
Maximum Soldering Temperature for Eutectic Devices using a Eutectic Solder Paste	240°C
Maximum Soldering Temperature for Lead-free Devices using a Lead-free Solder Paste	260°C

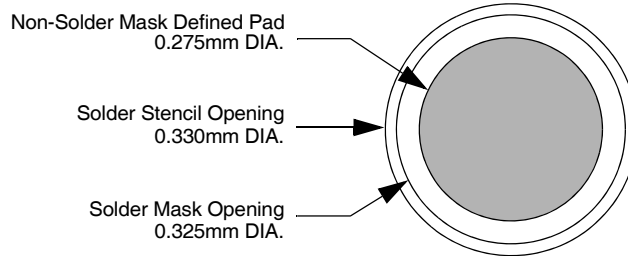

Figure 10. Recommended Non-Solder Mask Defined Pad Illustration

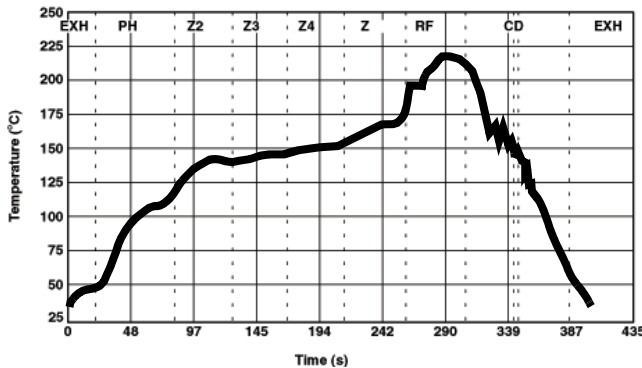

Figure 11. Eutectic (SnPb) Solder Ball Reflow Profile

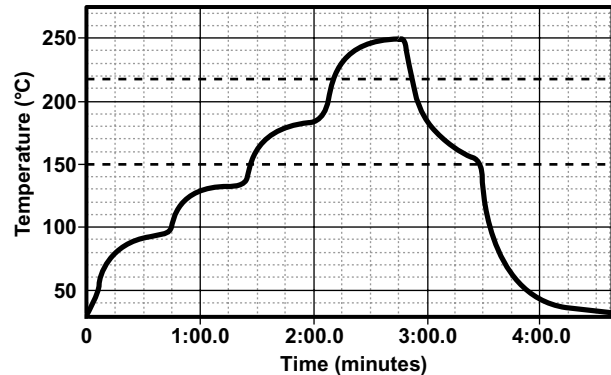

Figure 12. Lead-free (SnAgCu) Solder Ball Reflow Profile

Mechanical Details

CSP Mechanical Specifications

The CM1400-03 is supplied in a custom Chip Scale Package (CSP). Dimensions are presented below. For complete information on the CSP, see the California Micro Devices CSP Package Information document.

PACKAGE DIMENSIONS						
Package	Custom CSP					
Bumps	15					
Dim	Millimeters			Inches		
	Min	Nom	Max	Min	Nom	Max
A1	2.915	2.960	3.005	0.1148	0.1165	0.1183
A2	1.285	1.330	1.375	0.0506	0.0524	0.0541
B1	0.495	0.500	0.505	0.0195	0.0197	0.0199
B2	0.245	0.250	0.255	0.0096	0.0098	0.0100
B3	0.430	0.435	0.440	0.0169	0.0171	0.0173
B4	0.430	0.435	0.440	0.0169	0.0171	0.0173
C1	0.180	0.230	0.280	0.0071	0.0091	0.0110
C2	0.180	0.230	0.280	0.0071	0.0091	0.0110
D1	0.575	0.644	0.714	0.0226	0.0254	0.0281
D2	0.368	0.419	0.470	0.0145	0.0165	0.0185
# per tape and reel	3500 pieces					
Controlling dimension: millimeters						

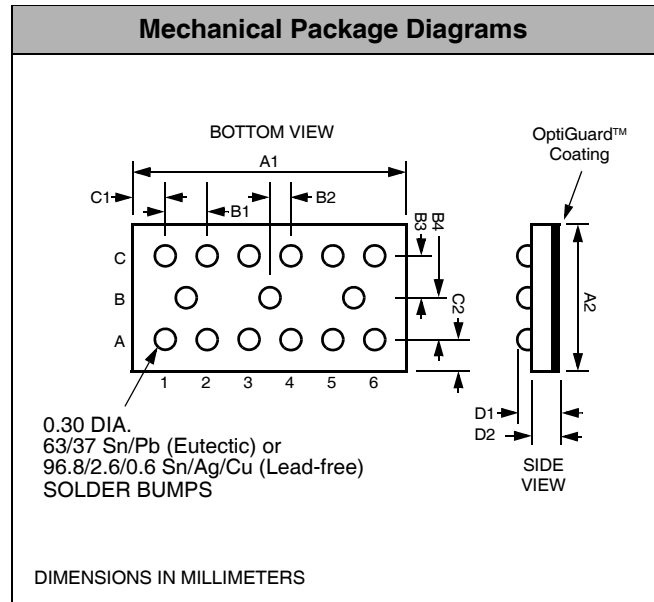

Package Dimensions for CM1400-03 Chip Scale Package

CSP Tape and Reel Specifications

PART NUMBER	CHIP SIZE (mm)	POCKET SIZE (mm) $B_0 \times A_0 \times K_0$	TAPE WIDTH W	REEL DIAMETER	QTY PER REEL	P_0	P_1
CM1400-03	2.96 X 1.33 X 0.644	3.10 X 1.45 X 0.74	8mm	178mm (7")	3500	4mm	4mm

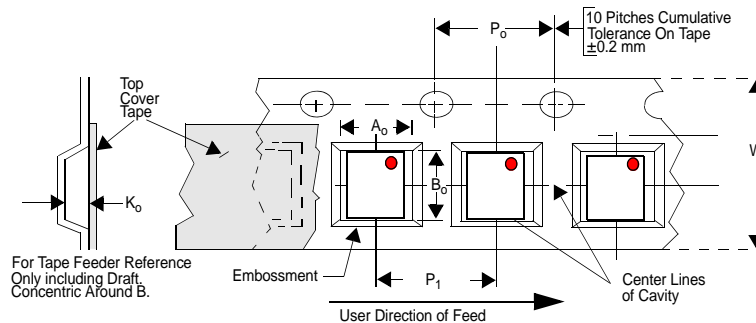

Figure 13. Tape and Reel Mechanical Data