

CM1409

LCD and Camera EMI Filter Array with ESD Protection

Product Description

The CM1409 is a family of pi-style EMI filter arrays with ESD protection, which integrates either six or eight filters (C-R-C) in a small form factor, WDFN 0.50 mm pitch package. The CM1409 has component values of 15 pF – 100 Ω – 15 pF per channel. The CM1409 has a cut-off frequency of 110 MHz and can be used in applications with data rates up to 44 Mbps. The parts include ESD diodes on every pin, which provide a very high level of protection for sensitive electronic components against electrostatic discharge (ESD). The ESD protected diodes safely dissipate ESD strikes of ±15 kV, which even exceeds the maximum requirement of the IEC61000-4-2 international standard. Using the MIL-STD-883 (Method 3015) specification for Human Body Model (HBM) ESD, the pins are protected for contact discharges at greater than ±30 kV.

These devices are particularly well-suited for portable electronics (e.g. wireless handsets, PDAs, notebook computers) because of their small package and easy-to-use pin assignments. In particular, the CM1409 is ideal for EMI filtering and protecting data and control lines for the I/O data ports, LCD display and camera interface in mobile handsets.

The CM1409 is housed in space-saving, low-profile 12- and 16-lead WDFN packages with a 0.50 mm pitch, RoHS-compliant, lead-free finishing.

Features

- Six or Eight Channels of EMI Filtering with Integrated ESD Protection
- Pi-Style EMI Filters in a Capacitor-Resistor-Capacitor (C-R-C) Network
- ±15 kV ESD Protection on Each Channel (IEC 61000-4-2 Level 4, Contact Discharge)
- ±30 kV ESD Protection on Each Channel (HBM)
- Greater than -35 dB Attenuation (Typical) at 1 GHz
- WDFN Package with 0.50 mm Lead Pitch:
 - 6-ch. = 12-lead WDFN
 - 8-ch. = 16-lead WDFN
- Tiny WDFN Package Size:
 - 12-lead: 3.0 mm x 1.35 mm
 - 16-lead: 4.0 mm x 1.60 mm
- Increased Robustness against Vertical Impacts During Manufacturing Process
- These Devices are Pb-Free and are RoHS Compliant

Applications

- LCD and Camera Data Lines in Mobile Handsets
- I/O Port Protection for Mobile Handsets, Notebook Computers, PDAs etc.
- EMI Filtering for Data Ports in Cell Phones, PDAs or Notebook Computers
- Wireless Handsets
- Handheld PCs/PDAs
- LCD and Camera Modules



ON Semiconductor®

<http://onsemi.com>

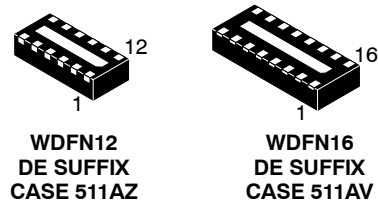

BLOCK DIAGRAM

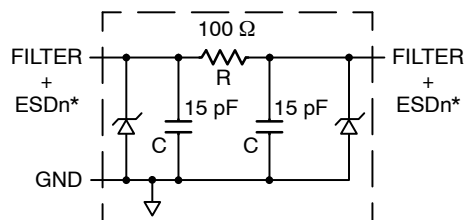

1 of 6 or 8 EMI/RFI + ESD Channels

*See Package/Pinout Diagrams for Expanded Pin Information.

MARKING DIAGRAM

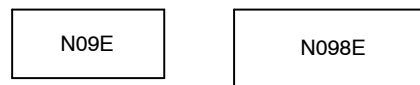

N09E = CM1409-06DE
N098E = CM1409-08DE

ORDERING INFORMATION

Device	Package	Shipping†
CM1409-06DE	WDFN12 (Pb-Free)	3000/Tape & Reel
CM1409-08DE	WDFN16 (Pb-Free)	3000/Tape & Reel

†For information on tape and reel specifications, including part orientation and tape sizes, please refer to our Tape and Reel Packaging Specification Brochure, BRD8011/D.

CM1409

PACKAGE / PINOUT DIAGRAMS

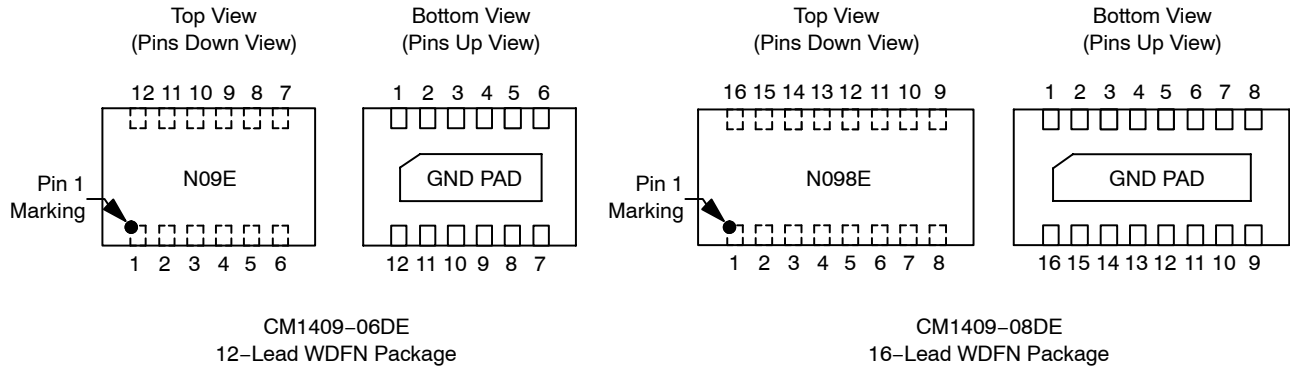

Table 1. PIN DESCRIPTIONS

Device Pin(s)		Name	Description	Device Pin(s)		Name	Description
-06	-08			-06	-08		
1	1	FILTER1	Filter + ESD Channel 1	12	16	FILTER1	Filter + ESD Channel 1
2	2	FILTER2	Filter + ESD Channel 2	11	15	FILTER2	Filter + ESD Channel 2
3	3	FILTER3	Filter + ESD Channel 3	10	14	FILTER3	Filter + ESD Channel 3
4	4	FILTER4	Filter + ESD Channel 4	9	13	FILTER4	Filter + ESD Channel 4
5	5	FILTER5	Filter + ESD Channel 5	8	12	FILTER5	Filter + ESD Channel 5
6	6	FILTER6	Filter + ESD Channel 6	7	11	FILTER6	Filter + ESD Channel 6
	7	FILTER7	Filter + ESD Channel 7		10	FILTER7	Filter + ESD Channel 7
	8	FILTER8	Filter + ESD Channel 8		9	FILTER8	Filter + ESD Channel 8
GND PAD		GND	Device Ground				

CM1409

SPECIFICATIONS

Table 2. ABSOLUTE MAXIMUM RATINGS

Parameter	Rating	Units
Storage Temperature Range	-65 to +150	°C
DC Power per Resistor	100	mW
DC Package Power Rating	500	mW

Stresses exceeding Maximum Ratings may damage the device. Maximum Ratings are stress ratings only. Functional operation above the Recommended Operating Conditions is not implied. Extended exposure to stresses above the Recommended Operating Conditions may affect device reliability.

Table 3. STANDARD OPERATING CONDITIONS

Parameter	Rating	Units
Operating Temperature Range	-40 to +85	°C

Table 4. ELECTRICAL OPERATING CHARACTERISTICS (Note 1)

Symbol	Parameter	Conditions	Min	Typ	Max	Units
R	Resistance		80	100	120	Ω
C _{TOTAL}	Total Channel Capacitance	At 2.5 VDC Reverse Bias, 1 MHz, 30 mVAC	24	30	36	pF
C	Capacitance C ₁	At 2.5 VDC Reverse Bias, 1 MHz, 30 mVAC		15		pF
V _{DIODE}	Standoff Voltage	I _{DIODE} = 10 μA		6.0		V
I _{LEAK}	Diode Leakage Current (Reverse Bias)	V _{DIODE} = 3.3 V		0.1	1.0	μA
V _{SIG}	Signal Clamp Voltage Positive Clamp Negative Clamp	I _{LOAD} = 10 mA I _{LOAD} = -10 mA	5.6 -1.5	6.8 -0.8	9.0 -0.4	V
V _{ESD}	In-system ESD Withstand Voltage a) Human Body Model, MIL-STD-883, Method 3015 b) Contact Discharge per IEC 61000-4-2 Level 4	(Note 2)	±30 ±15			kV
R _{DYN}	Dynamic Resistance Positive Negative			2.3 0.9		Ω
f _C	Cut-off Frequency Z _{SOURCE} = 50 Ω, Z _{LOAD} = 50 Ω	Channel R = 100 Ω, Channel C = 15 pF		110		MHz
A _{1GHz}	Absolute Attenuation @ 1GHz from 0 dB Level	Z _{SOURCE} = 50 Ω, Z _{LOAD} = 50 Ω, DC Bias = 0 V (Notes 1 and 3)		35		dB
A _{800MHz-6GHz}	Absolute Attenuation @ 800 MHz to 6 GHz from 0 dB Level	Z _{SOURCE} = 50 Ω, Z _{LOAD} = 50 Ω, DC Bias = 0 V (Notes 1 and 3)		30		dB

1. T_A = 25°C unless otherwise specified.
2. ESD applied to input and output pins with respect to GND, one at a time.
3. Attenuation / RF curves characterized by a network analyzer using microprobes.

CM1409

PERFORMANCE INFORMATION

Typical Filter Performance ($T_A = 25^\circ\text{C}$, DC Bias = 0 V, 50 Ω Environment)

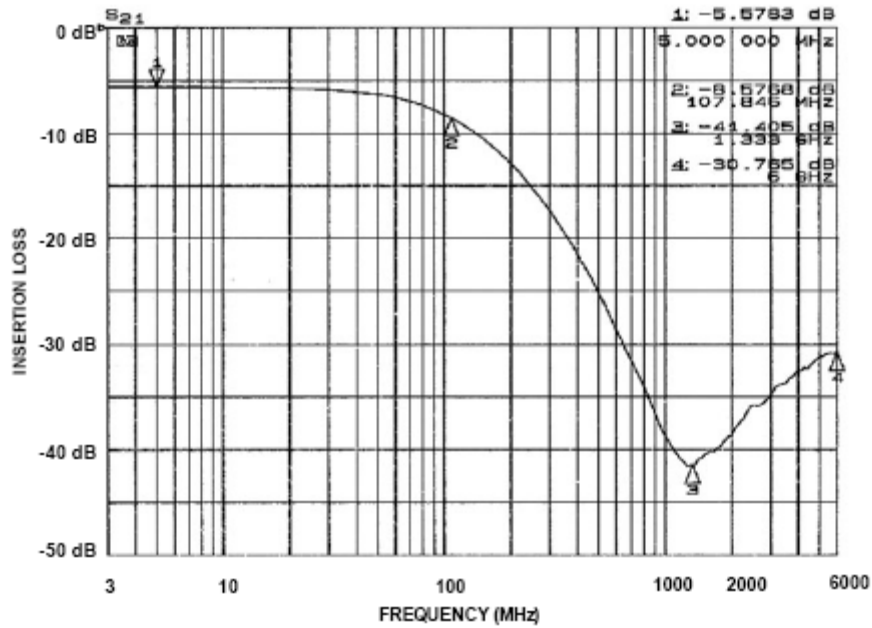

Figure 1. Insertion Loss vs. Frequency (FILTER1 Input to GND)

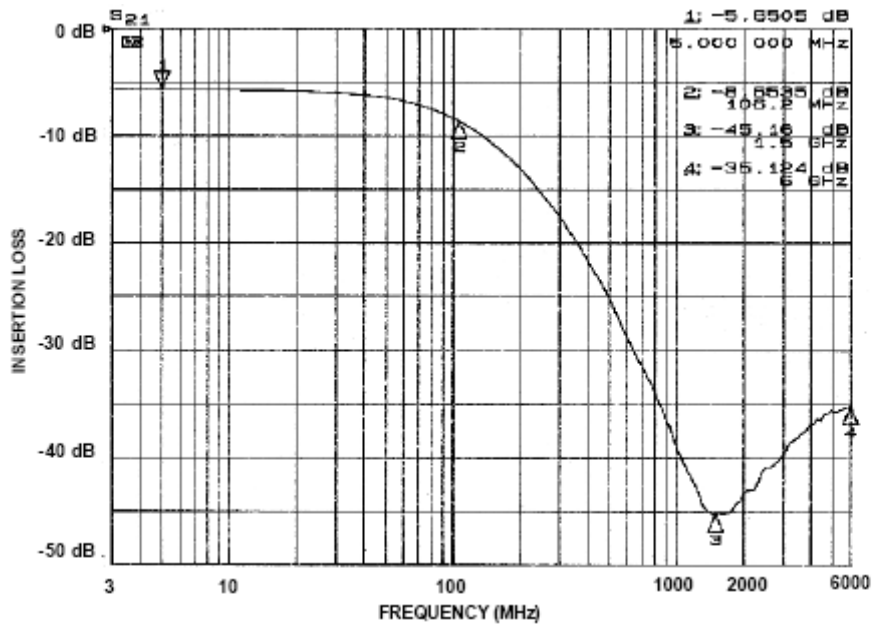

Figure 2. Insertion Loss vs. Frequency (FILTER2 Input to GND)

PERFORMANCE INFORMATION (Cont'd)

Typical Filter Performance ($T_A = 25^\circ\text{C}$, DC Bias = 0 V, 50 Ω Environment)

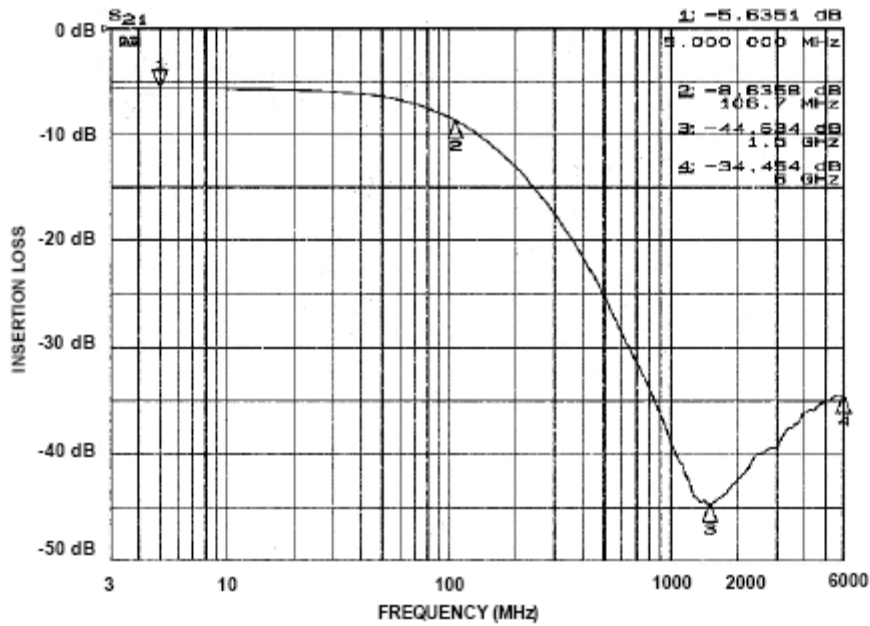

Figure 3. Insertion Loss vs. Frequency (FILTER3 Input to GND)

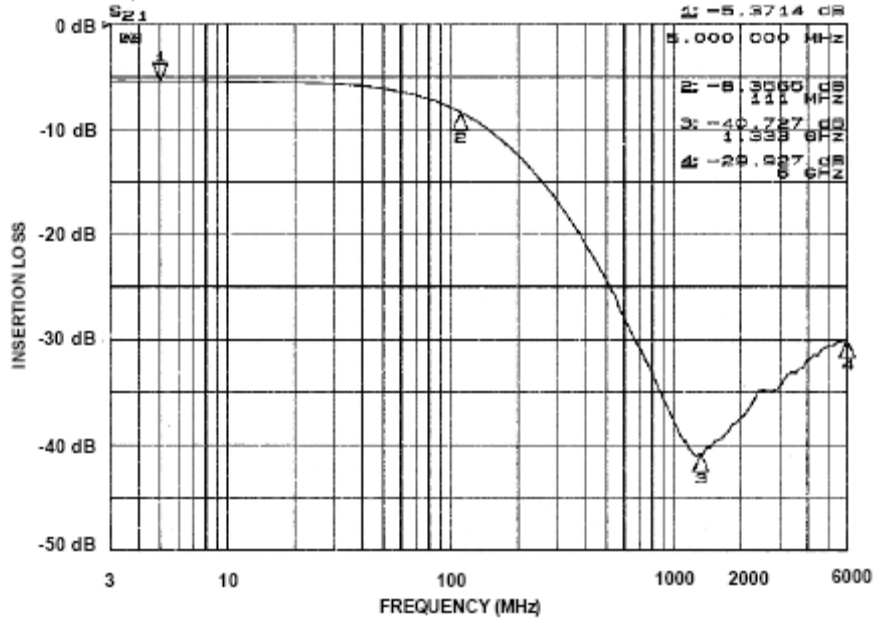

Figure 4. Insertion Loss vs. Frequency (FILTER4 Input to GND)

PERFORMANCE INFORMATION (Cont'd)

Typical Diode Capacitance vs. Input Voltage

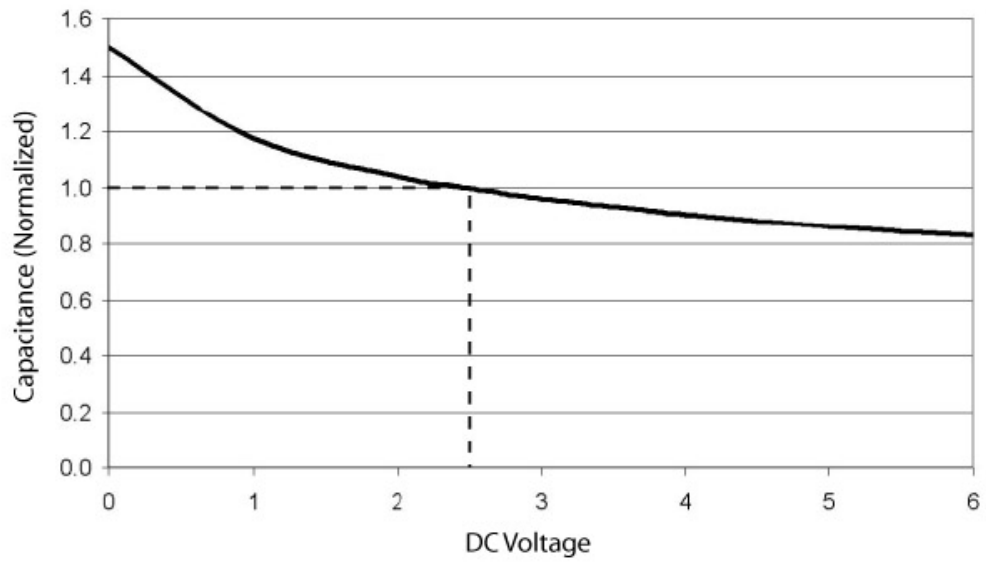
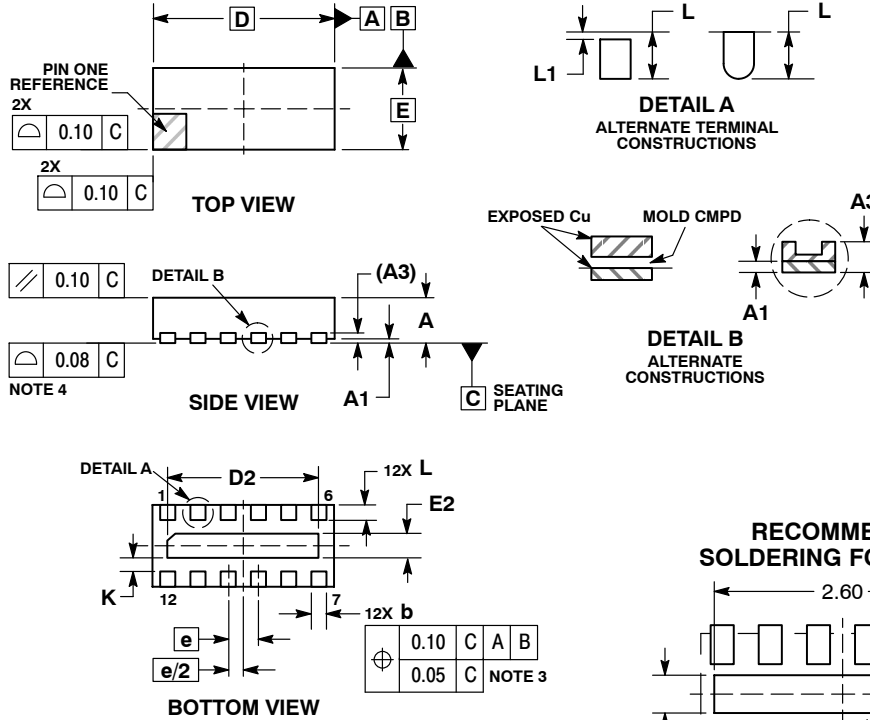

Figure 5. Filter Capacitance vs. Input Voltage (normalized to capacitance at 2.5 VDC and 25°C)

CM1409

PACKAGE DIMENSIONS

WDFN12, 3x1.35, 0.5P
CASE 511AZ-01
ISSUE O



- NOTES:
1. DIMENSIONING AND TOLERANCING PER ASME Y14.5M, 1994.
 2. CONTROLLING DIMENSION: MILLIMETERS.
 3. DIMENSION b APPLIES TO PLATED TERMINAL AND IS MEASURED BETWEEN 0.15 AND 0.30 MM FROM TERMINAL TIP.
 4. COPLANARITY APPLIES TO THE EXPOSED PAD AS WELL AS THE TERMINALS.

MILLIMETERS		
DIM	MIN	MAX
A	0.70	0.80
A1	0.00	0.05
A3	0.20	REF
b	0.20	0.30
D	3.00	BSC
D2	2.40	2.60
E	1.35	BSC
E2	0.30	0.50
e	0.50	BSC
K	0.22	REF
L	0.20	0.30
L1	---	0.15

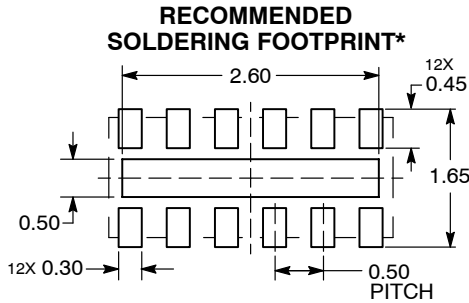

DIMENSION: MILLIMETERS

*For additional information on our Pb-Free strategy and soldering details, please download the ON Semiconductor Soldering and Mounting Techniques Reference Manual, SOLDERRM/D.

CM1409

PACKAGE DIMENSIONS

WDFN16, 4x1.6, 0.5P
CASE 511AV-01
ISSUE 0

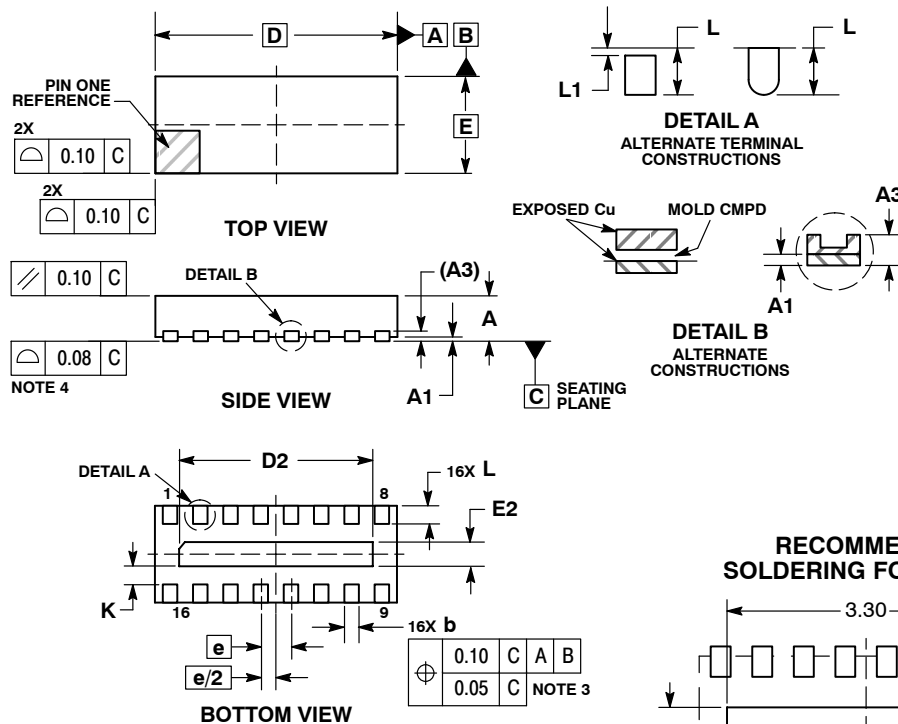

NOTES:

1. DIMENSIONING AND TOLERANCING PER ASME Y14.5M, 1994.
2. CONTROLLING DIMENSION: MILLIMETERS.
3. DIMENSION b APPLIES TO PLATED TERMINAL AND IS MEASURED BETWEEN 0.15 AND 0.30 MM FROM TERMINAL TIP.
4. COPLANARITY APPLIES TO THE EXPOSED PAD AS WELL AS THE TERMINALS.

MILLIMETERS		
DIM	MIN	MAX
A	0.70	0.80
A1	0.00	0.05
A3	0.20	REF
b	0.20	0.30
D	4.00	BSC
D2	3.10	3.30
E	1.60	BSC
E2	0.30	0.50
e	0.50	BSC
K	0.30	REF
L	0.20	0.40
L1	---	0.15

RECOMMENDED SOLDERING FOOTPRINT*

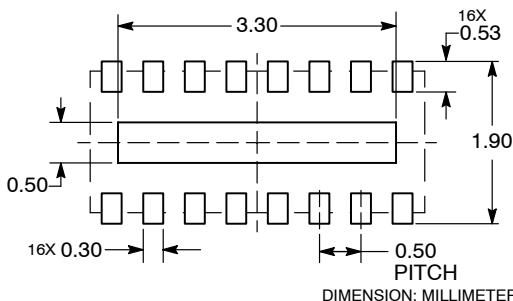

*For additional information on our Pb-Free strategy and soldering details, please download the ON Semiconductor Soldering and Mounting Techniques Reference Manual, SOLDERRM/D.

ON Semiconductor and are registered trademarks of Semiconductor Components Industries, LLC (SCILLC). SCILLC reserves the right to make changes without further notice to any products herein. SCILLC makes no warranty, representation or guarantee regarding the suitability of its products for any particular purpose, nor does SCILLC assume any liability arising out of the application or use of any product or circuit, and specifically disclaims any and all liability, including without limitation special, consequential or incidental damages. "Typical" parameters which may be provided in SCILLC data sheets and/or specifications can and do vary in different applications and actual performance may vary over time. All operating parameters, including "Typicals" must be validated for each customer application by customer's technical experts. SCILLC does not convey any license under its patent rights nor the rights of others. SCILLC products are not designed, intended, or authorized for use as components in systems intended for surgical implant into the body, or other applications intended to support or sustain life, or for any other application in which the failure of the SCILLC product could create a situation where personal injury or death may occur. Should Buyer purchase or use SCILLC products for any such unintended or unauthorized application, Buyer shall indemnify and hold SCILLC and its officers, employees, subsidiaries, affiliates, and distributors harmless against all claims, costs, damages, and expenses, and reasonable attorney fees arising out of, directly or indirectly, any claim of personal injury or death associated with such unintended or unauthorized use, even if such claim alleges that SCILLC was negligent regarding the design or manufacture of the part. SCILLC is an Equal Opportunity/Affirmative Action Employer. This literature is subject to all applicable copyright laws and is not for resale in any manner.

PUBLICATION ORDERING INFORMATION

LITERATURE FULFILLMENT:
Literature Distribution Center for ON Semiconductor
P.O. Box 5163, Denver, Colorado 80217 USA
Phone: 303-675-2175 or 800-344-3860 Toll Free USA/Canada
Fax: 303-675-2176 or 800-344-3867 Toll Free USA/Canada
Email: orderlit@onsemi.com

N. American Technical Support: 800-282-9855 Toll Free USA/Canada
Europe, Middle East and Africa Technical Support:
Phone: 421 33 790 2910
Japan Customer Focus Center
Phone: 81-3-5773-3850

ON Semiconductor Website: www.onsemi.com
Order Literature: <http://www.onsemi.com/orderlit>

For additional information, please contact your local Sales Representative