

# CM1423

## Secure Digital (SD) Card EMI Filter Array with ESD Protection

### Product Description

The CM1423 is an EMI filter array with ESD protection, which integrates six Pi- filters (C-R-C) and four channels of ESD protection. The CM1423's filters have component values of 12 pF – 100 Ω – 12 pF. The part includes ESD protection diodes on every pin, which provide a very high level of protection for sensitive electronic components that may be subjected to electrostatic discharge (ESD). All the ESD diodes safely dissipate ESD strikes of ±15 kV, beyond the maximum requirement of the IEC 61000-4-2 international standard. Using the MIL-STD-883 (Method 3015) specification for Human Body Model (HBM) ESD, the pins are protected for contact discharges at greater than ±30 kV.

This device is particularly well-suited for portable electronics (e.g. mobile handsets, PDAs, notebook computers) because of its small package and easy-to-use pin assignments. In particular, the CM1423 is ideal for EMI filtering and protecting data lines from ESD for the Secure Digital (SD) Card interface slot in mobile handsets. The CM1423 is an all-inclusive solution for the SD card interface since its EMI filters provide the proper cut-off frequency to attenuate unwanted signals.

The CM1423 is manufactured in a space-saving, low-profile, chip-scale package, and is optionally available with *OptiGuard*<sup>™</sup> coating for improved reliability. It is available with RoHS compliant lead-free finishing.

### Features

- Provides EMI Filtering and ESD Protection for an SD Port on a Mobile Device
- Six Channels of EMI Filtering with ESD Protection
- Four Channels of ESD Protection
- ±15 kV ESD Protection on All I/O Pins (IEC 61000-4-2, Contact Discharge)
- ±30 kV ESD Protection (HBM)
- Better than 25 dB of Attenuation at 1 GHz for 12 pF – 100 Ω – 12 pF Filter Configuration
- Integrates 34 Components Into Mini form Factor CSP Solution
- 20-Bump, 4.000 mm X 1.458 mm Footprint Chip Scale Package

### Applications

- Secure Digital (SD) Card Data Lines in Mobile Handsets
- SD Card Interface Protection for Other Mobile Electronics such as MP3 Players, PDAs and Digital Cameras



ON Semiconductor®

<http://onsemi.com>



WLCSP20  
CP SUFFIX  
CASE 567BZ

### MARKING DIAGRAM

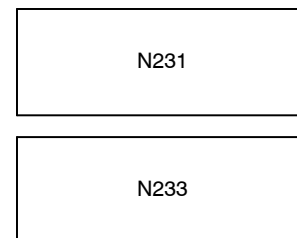

N231 = CM1423-01CP  
N233 = CM1423-03CP

### ORDERING INFORMATION

Device	Package	Shipping <sup>†</sup>
CM1423-01CP	CSP-20 (Pb-Free)	3500/Tape & Reel
CM1423-03CP	CSP-20 (Pb-Free)	3500/Tape & Reel

<sup>†</sup>For information on tape and reel specifications, including part orientation and tape sizes, please refer to our Tape and Reel Packaging Specification Brochure, BRD8011/D.

- Chip Scale Package Features Extremely Low Lead Inductance for Optimum Filter and ESD Performance
- Available with *OptiGuard*<sup>™</sup> Coating for Improved Reliability at Assembly
- These Devices are Pb-Free and are RoHS Compliant
- I/O Port Protection for Mobile Handsets, Notebook Computers, PDAs, etc.
- EMI Filtering for Data Ports in Cell Phones, PDAs or Notebook Computers

# CM1423

## BLOCK DIAGRAM

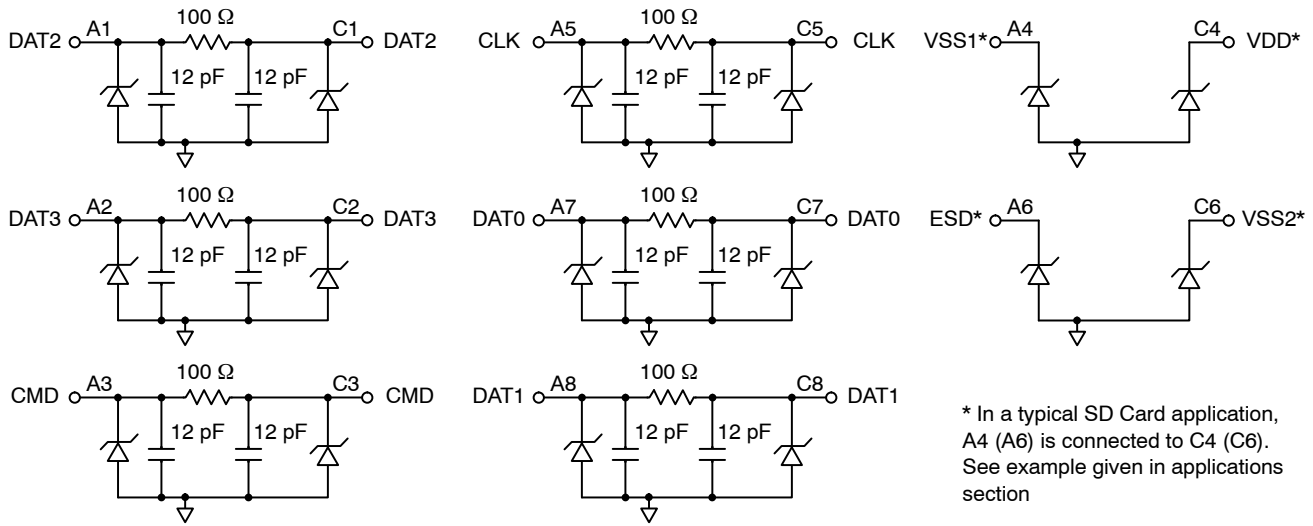

## PACKAGE / PINOUT DIAGRAMS

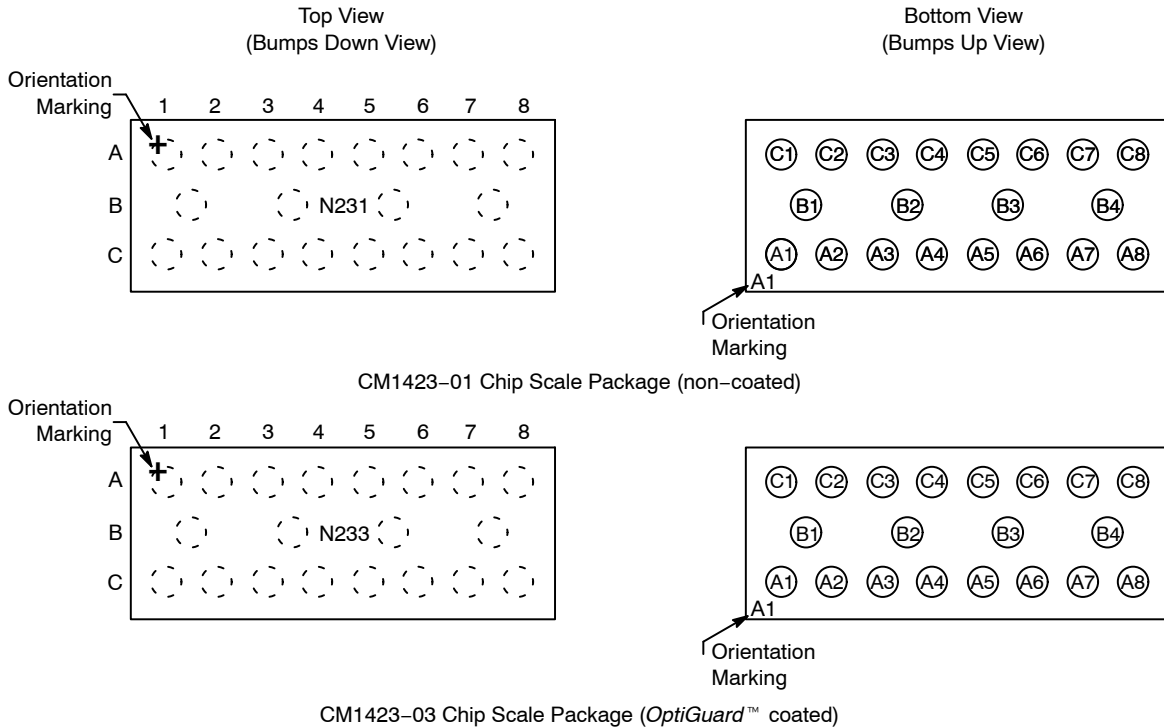

# CM1423

**Table 1. PIN DESCRIPTIONS**

Pin(s)	Name	Description	Pin(s)	Name	Description
A1	DAT2	DATA2 Filter + ESD Channel, System Side	C1	DAT2	DATA2 Filter + ESD Channel, SD Card Side
A2	DAT3	DATA3 Filter + ESD Channel, System Side	C2	DAT3	DATA3 Filter + ESD Channel, SD Card Side
A3	CMD	CMD Signal Filter + ESD Channel, System Side	C3	CMD	CMD Signal Filter + ESD Channel, SD Card Side
A4	VSS1	ESD – only Channel, Supply Voltage Ground	C4	VDD	ESD – only Channel, Supply Voltage
A5	CLK	Clock Filter + ESD Channel	C5	CLK	Clock Filter + ESD Channel
A6	ESD	ESD – only Channel	C6	VSS2	ESD – only Channel, Supply Voltage Ground
A7	DAT0	DATA0 Filter + ESD Channel, System Side	C7	DAT0	DATA0 Filter + ESD Channel, SD Card Side
A8	DAT1	DATA1 Filter + ESD Channel, System Side	C8	DAT1	DATA1 Filter + ESD Channel, SD Card Side
B1–B4	GND	Device Ground			

## SPECIFICATIONS

**Table 2. ABSOLUTE MAXIMUM RATINGS**

Parameter	Rating	Units
Storage Temperature Range	–65 to +150	°C
DC Power per Resistor	100	mW
DC Package Power Rating	500	mW

Stresses exceeding Maximum Ratings may damage the device. Maximum Ratings are stress ratings only. Functional operation above the Recommended Operating Conditions is not implied. Extended exposure to stresses above the Recommended Operating Conditions may affect device reliability.

**Table 3. STANDARD OPERATING CONDITIONS**

Parameter	Rating	Units
Operating Temperature Range	–40 to +85	°C

**Table 4. ELECTRICAL OPERATING CHARACTERISTICS** (Note 1)

Symbol	Parameter	Conditions	Min	Typ	Max	Units
R	Resistance		80	100	120	Ω
C	Capacitance	At 2.5 V DC, 1 MHz, 30 mV AC	9	12	15	pF
V <sub>DIODE</sub>	Diode Stand-off Voltage	I <sub>DIODE</sub> = 10 μA		6.0		V
I <sub>LEAK</sub>	Diode Leakage Current (Reverse Bias)	V <sub>DIODE</sub> = 3.3 V		100	300	nA
V <sub>SIG</sub>	Signal Voltage Positive Clamp Negative Clamp	I <sub>LOAD</sub> = 10 mA I <sub>LOAD</sub> = –10 mA	5.6 –1.5	6.8 –0.8	9.0 –0.4	V
V <sub>ESD</sub>	In-system ESD Withstand Voltage a) Human Body Model, MIL-STD-883, Method 3015 b) Contact Discharge per IEC 61000-4-2 Level 4	(Note 2)	±30 ±15			kV
R <sub>DYN</sub>	Dynamic Resistance Positive Negative			1.6 0.4		Ω
f <sub>C</sub>	Cut-off Frequency, Z <sub>SOURCE</sub> = 50 Ω, Z <sub>LOAD</sub> = 50 Ω	R = 100 Ω, C = 12 pF		145		MHz

1. T<sub>A</sub> = 25°C unless otherwise specified.
2. ESD applied to input and output pins with respect to GND, one at a time.

# CM1423

## PERFORMANCE INFORMATION

Typical Filter Performance (nominal conditions unless specified otherwise, 50 Ω Environment)

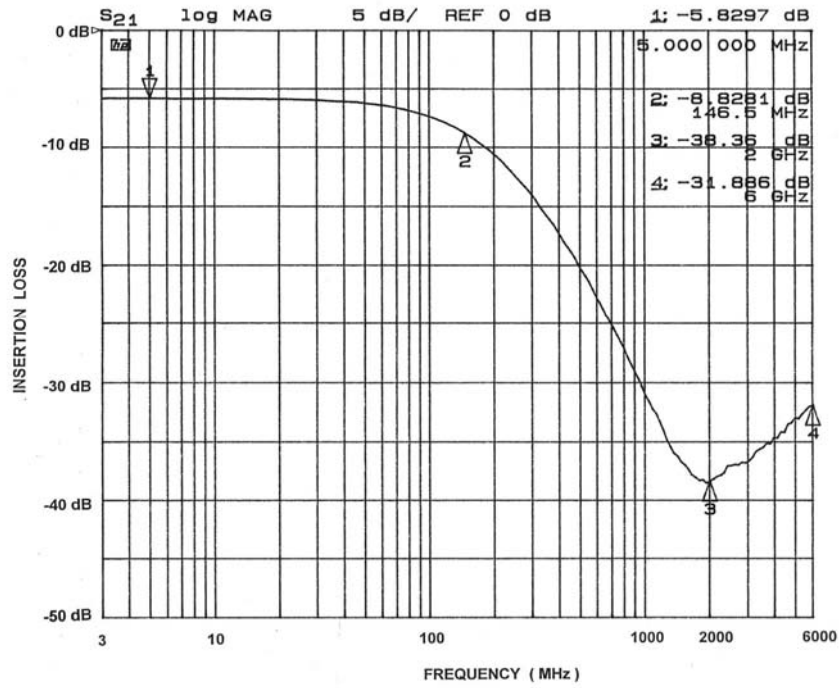

Figure 1. A1-C1 EMI Filter Performance

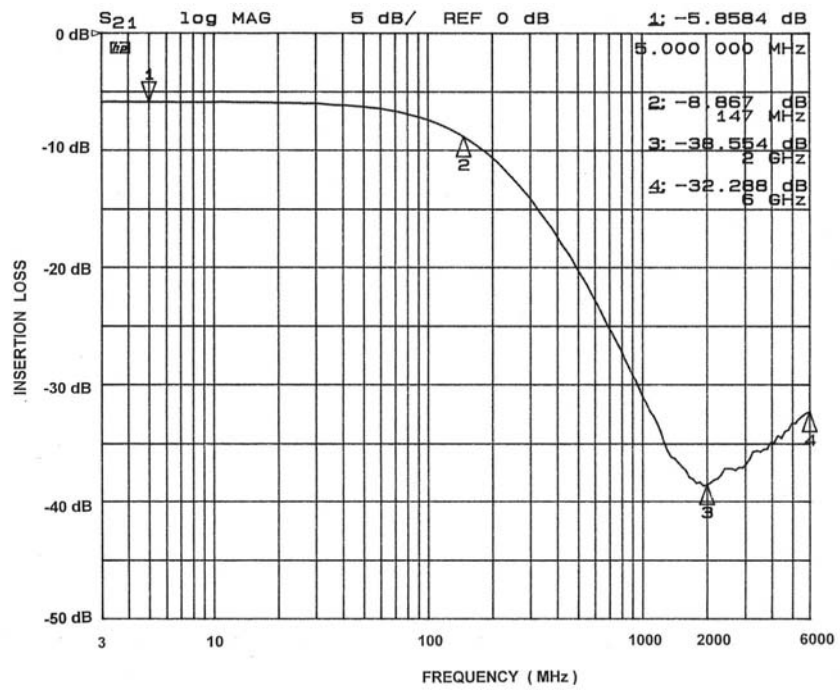

Figure 2. A2-C2 EMI Filter Performance

PERFORMANCE INFORMATION (Cont'd)

Typical Filter Performance (nominal conditions unless specified otherwise, 50 Ω Environment)

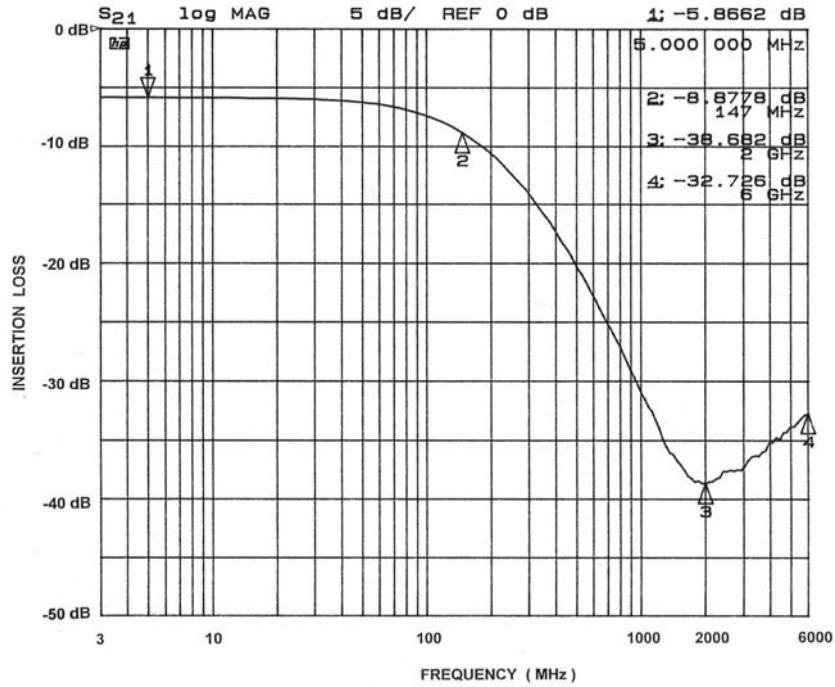

Figure 3. A3-C3 EMI Filter Performance

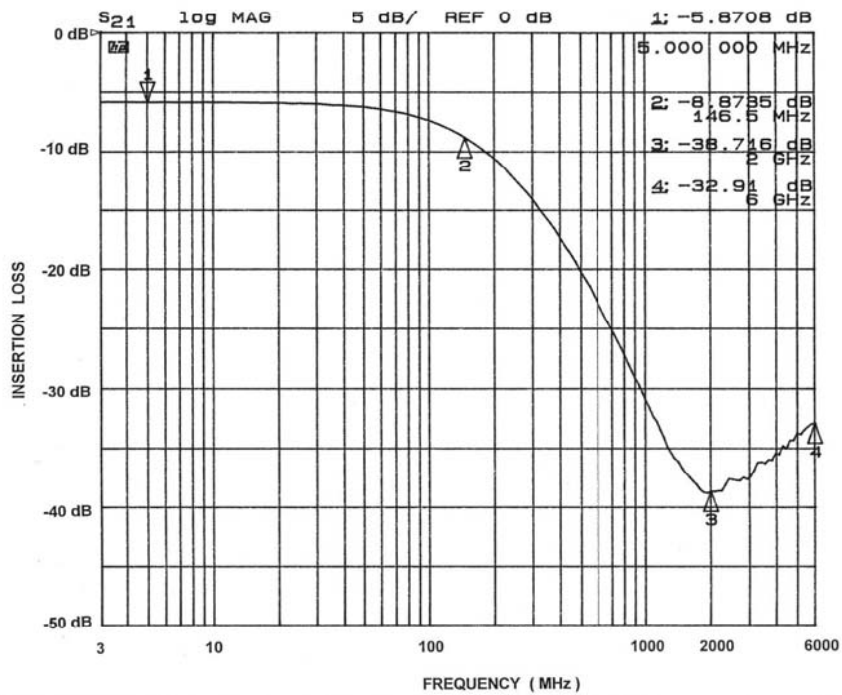

Figure 4. A5-C5 EMI Filter Performance

# CM1423

## PERFORMANCE INFORMATION (Cont'd)

Typical Filter Performance (nominal conditions unless specified otherwise, 50 Ω Environment)

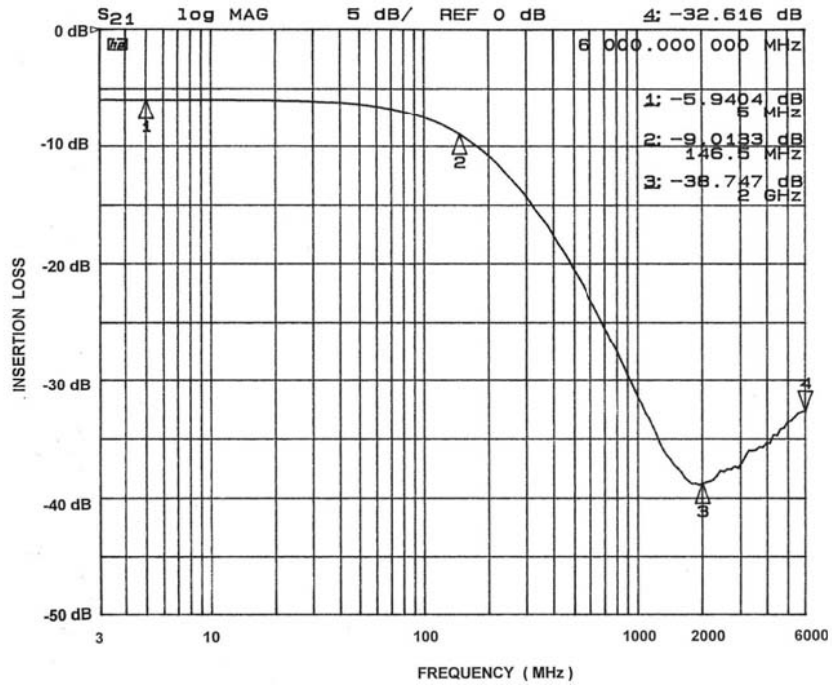

Figure 5. A7-C7 EMI Filter Performance

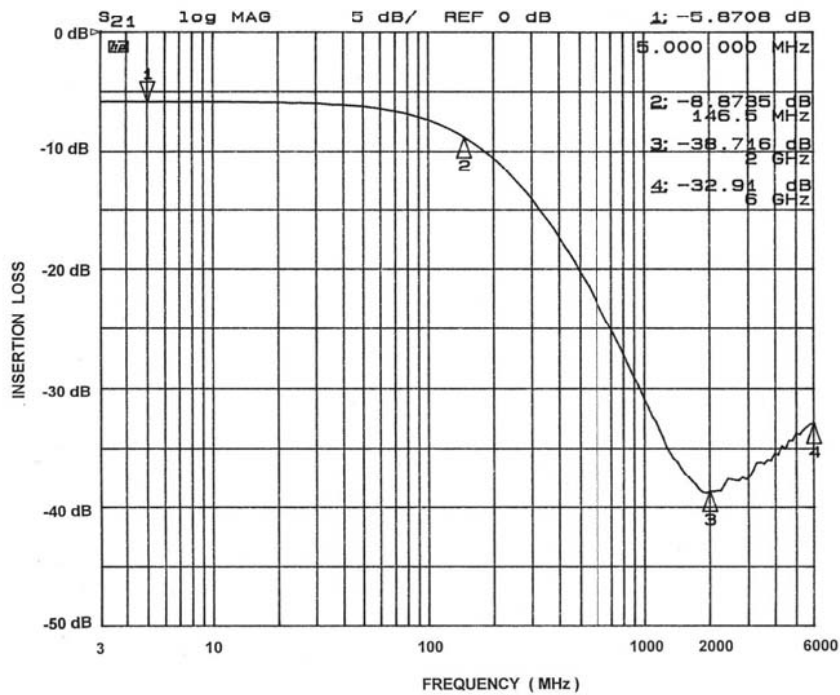

Figure 6. A8-C8 EMI Filter Performance

PERFORMANCE INFORMATION (Cont'd)

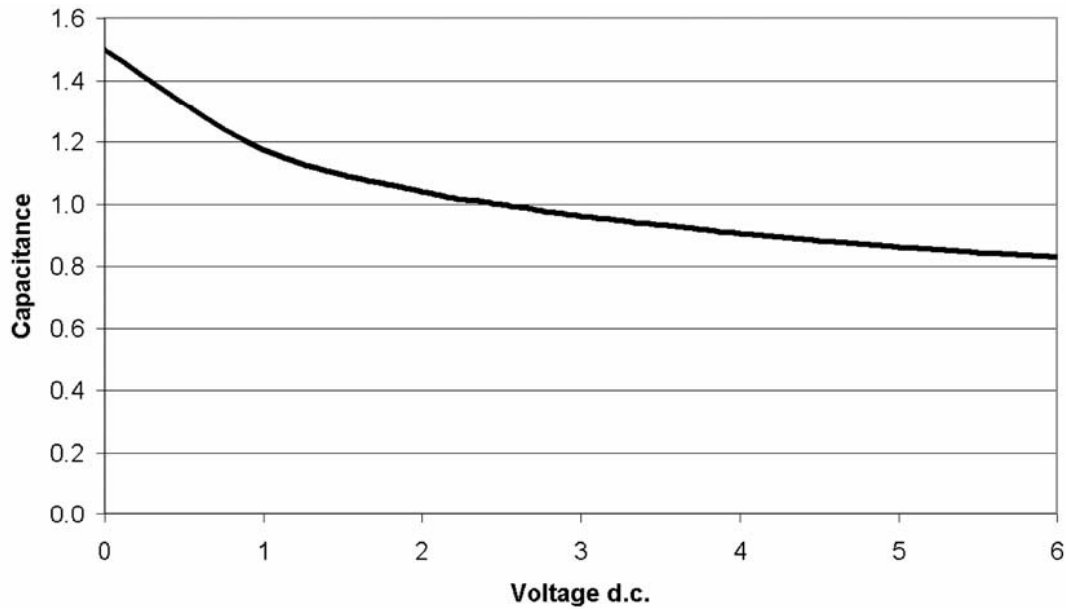
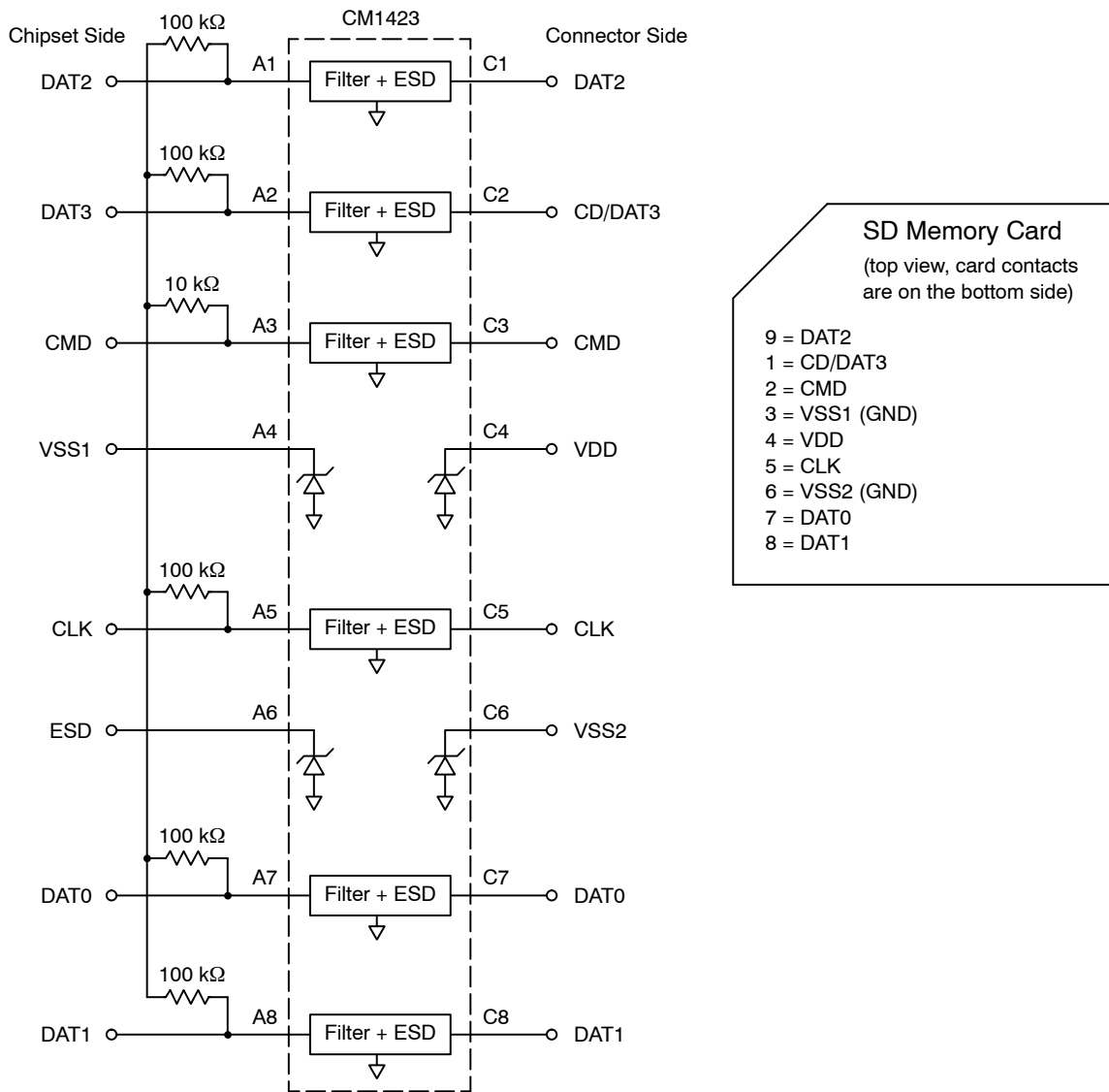

Figure 7. Filter Capacitance vs. Input Voltage over Temperature  
(normalized to capacitance at 2.5 V DC and 25°C)

# CM1423

## APPLICATION INFORMATION



Note: 100 kΩ and 10 kΩ pull-up resistors are not included in CM1423. Designer will need to determine the appropriate pull-up resistor value for each design.

**Figure 8. Typical SD Card Application**



APPLICATION INFORMATION (Cont'd)

Parameter	Value
Pad Size on PCB	0.240 mm
Pad Shape	Round
Pad Definition	Non-Solder Mask defined pads
Solder Mask Opening	0.290 mm Round
Solder Stencil Thickness	0.125 mm – 0.150 mm
Solder Stencil Aperture Opening (laser cut, 5% tapered walls)	0.300 mm Round
Solder Flux Ratio	50/50 by volume
Solder Paste Type	No Clean
Pad Protective Finish	OSP (Entek Cu Plus 106A)
Tolerance – Edge To Corner Ball	±50 µm
Solder Ball Side Coplanarity	±20 µm
Maximum Dwell Time Above Liquidous	60 seconds
Maximum Soldering Temperature for Lead-free Devices using a Lead-free Solder Paste	260°C

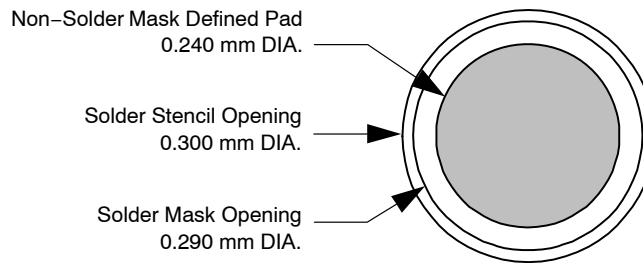

Figure 9. Recommended Non-Solder Mask Defined Pad Illustration

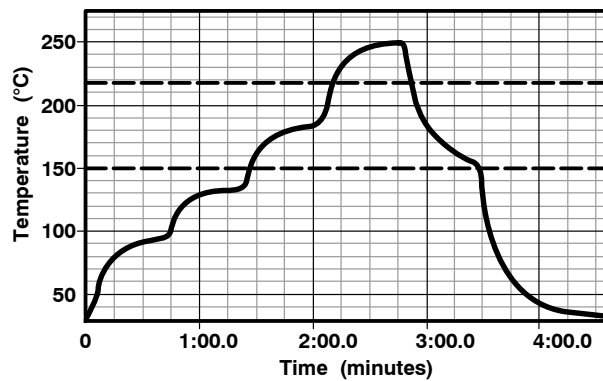

Figure 10. Lead-free (SnAgCu) Solder Ball Reflow Profile

# MECHANICAL CASE OUTLINE

## PACKAGE DIMENSIONS

ON Semiconductor®



WLCSP20, 4.00x1.46  
CASE 567BZ-01  
ISSUE O

DATE 26 JUL 2010

SCALE 4:1

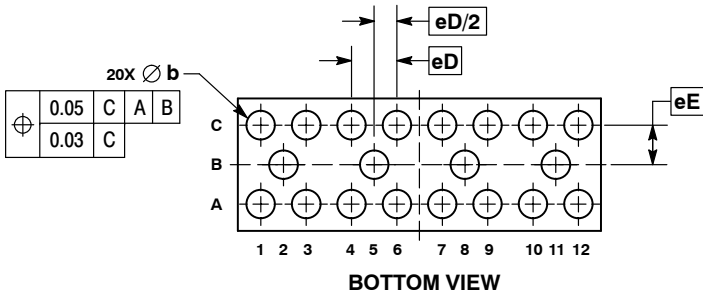
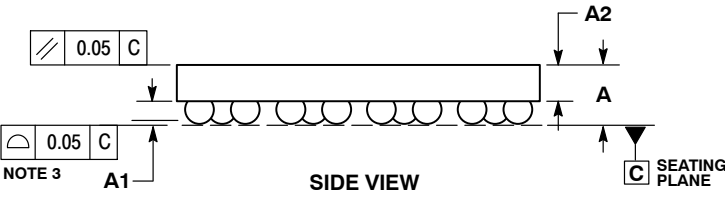
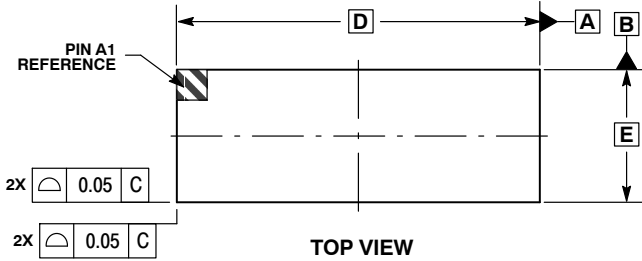

- NOTES:
1. DIMENSIONING AND TOLERANCING PER ASME Y14.5M, 1994.
  2. CONTROLLING DIMENSION: MILLIMETERS.
  3. COPLANARITY APPLIES TO SPHERICAL CROWNS OF SOLDER BALLS.

DIM	MILLIMETERS	
	MIN	MAX
A	0.56	0.65
A1	0.21	0.27
A2	0.40 REF	
b	0.29	0.35
D	4.00 BSC	
E	1.46 BSC	
eD	0.50 BSC	
eE	0.435 BSC	

### RECOMMENDED SOLDERING FOOTPRINT\*

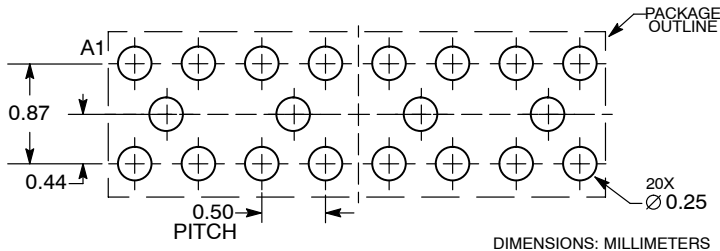

\*For additional information on our Pb-Free strategy and soldering details, please download the ON Semiconductor Soldering and Mounting Techniques Reference Manual, SOLDERRM/D.

<b>DOCUMENT NUMBER:</b>	<b>98AON49833E</b>	Electronic versions are uncontrolled except when accessed directly from the Document Repository. Printed versions are uncontrolled except when stamped "CONTROLLED COPY" in red.
<b>DESCRIPTION:</b>	<b>WLCSP20, 4.00X1.46</b>	<b>PAGE 1 OF 1</b>

ON Semiconductor and are trademarks of Semiconductor Components Industries, LLC dba ON Semiconductor or its subsidiaries in the United States and/or other countries. ON Semiconductor reserves the right to make changes without further notice to any products herein. ON Semiconductor makes no warranty, representation or guarantee regarding the suitability of its products for any particular purpose, nor does ON Semiconductor assume any liability arising out of the application or use of any product or circuit, and specifically disclaims any and all liability, including without limitation special, consequential or incidental damages. ON Semiconductor does not convey any license under its patent rights nor the rights of others.

**onsemi**, **Onsemi**, and other names, marks, and brands are registered and/or common law trademarks of Semiconductor Components Industries, LLC dba "**onsemi**" or its affiliates and/or subsidiaries in the United States and/or other countries. **onsemi** owns the rights to a number of patents, trademarks, copyrights, trade secrets, and other intellectual property. A listing of **onsemi**'s product/patent coverage may be accessed at [www.onsemi.com/site/pdf/Patent-Marking.pdf](http://www.onsemi.com/site/pdf/Patent-Marking.pdf). **onsemi** reserves the right to make changes at any time to any products or information herein, without notice. The information herein is provided "as-is" and **onsemi** makes no warranty, representation or guarantee regarding the accuracy of the information, product features, availability, functionality, or suitability of its products for any particular purpose, nor does **onsemi** assume any liability arising out of the application or use of any product or circuit, and specifically disclaims any and all liability, including without limitation special, consequential or incidental damages. Buyer is responsible for its products and applications using **onsemi** products, including compliance with all laws, regulations and safety requirements or standards, regardless of any support or applications information provided by **onsemi**. "Typical" parameters which may be provided in **onsemi** data sheets and/or specifications can and do vary in different applications and actual performance may vary over time. All operating parameters, including "Typicals" must be validated for each customer application by customer's technical experts. **onsemi** does not convey any license under any of its intellectual property rights nor the rights of others. **onsemi** products are not designed, intended, or authorized for use as a critical component in life support systems or any FDA Class 3 medical devices or medical devices with a same or similar classification in a foreign jurisdiction or any devices intended for implantation in the human body. Should Buyer purchase or use **onsemi** products for any such unintended or unauthorized application, Buyer shall indemnify and hold **onsemi** and its officers, employees, subsidiaries, affiliates, and distributors harmless against all claims, costs, damages, and expenses, and reasonable attorney fees arising out of, directly or indirectly, any claim of personal injury or death associated with such unintended or unauthorized use, even if such claim alleges that **onsemi** was negligent regarding the design or manufacture of the part. **onsemi** is an Equal Opportunity/Affirmative Action Employer. This literature is subject to all applicable copyright laws and is not for resale in any manner.

## PUBLICATION ORDERING INFORMATION

### LITERATURE FULFILLMENT:

Email Requests to: [orderlit@onsemi.com](mailto:orderlit@onsemi.com)

**onsemi Website:** [www.onsemi.com](http://www.onsemi.com)

### TECHNICAL SUPPORT

**North American Technical Support:**

Voice Mail: 1 800-282-9855 Toll Free USA/Canada

Phone: 011 421 33 790 2910

**Europe, Middle East and Africa Technical Support:**

Phone: 00421 33 790 2910

For additional information, please contact your local Sales Representative