



Features

- Eight channels of EMI filtering with integrated ESD protection
- Pi-style EMI filters in a capacitor-resistor-capacitor (C-R-C) network
- $\pm 15\text{kV}$ ESD protection on each channel (IEC 61000-4-2 Level 4, contact discharge)
- $\pm 30\text{kV}$ ESD protection on each channel (HBM)
- Greater than -35dB attenuation (typical) at 1GHz
- NuDFN package with 0.40mm lead pitch:
 - 16-lead: $3.5\text{mm} \times 1.20\text{mm} \times 0.50\text{mm}$
- Lead-free finishing

Applications

- LCD and camera data lines in mobile handsets
- I/O port protection for mobile handsets, notebook computers, PDAs, etc.
- EMI filtering for data ports in cell phones, PDAs or notebook computers
- Wireless handsets
- Handheld PCs/PDAs

Electrical Schematic

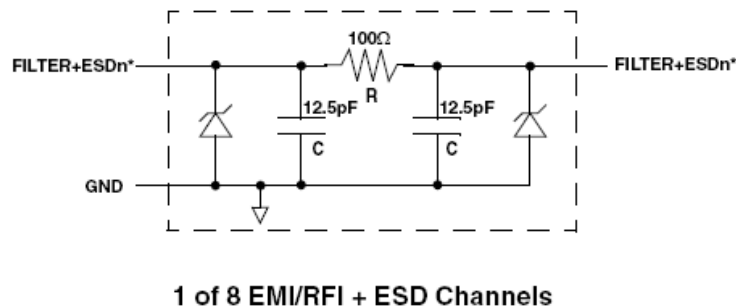

* See Package/Pinout Diagram
for expanded pin information.

PACKAGE / PINOUT DIAGRAMS

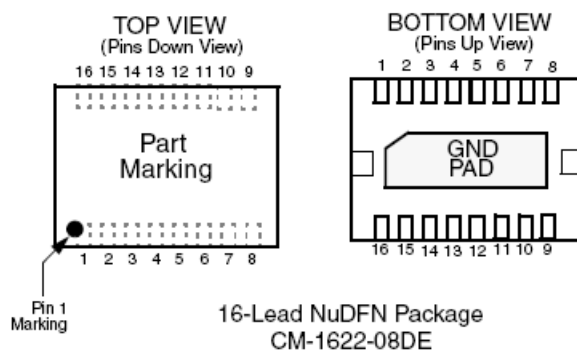

Note: These drawings are not to scale.

16-PIN DESCRIPTIONS

DEVICE PIN(s)	NAME	DESCRIPTION	DEVICE PIN(s)	NAME	DESCRIPTION
1	FILTER1	Filter + ESD Channel 1	16	FILTER1	Filter + ESD Channel 1
2	FILTER2	Filter + ESD Channel 2	15	FILTER2	Filter + ESD Channel 2
3	FILTER3	Filter + ESD Channel 3	14	FILTER3	Filter + ESD Channel 3
4	FILTER4	Filter + ESD Channel 4	13	FILTER4	Filter + ESD Channel 4
5	FILTER5	Filter + ESD Channel 5	12	FILTER5	Filter + ESD Channel 5
6	FILTER6	Filter + ESD Channel 6	11	FILTER6	Filter + ESD Channel 6
7	FILTER7	Filter + ESD Channel 7	10	FILTER7	Filter + ESD Channel 7
8	FILTER8	Filter + ESD Channel 8	9	FILTER8	Filter + ESD Channel 8
GND PAD	GND	Device Ground			

Ordering Information

PART NUMBERING INFORMATION			
Pins	Package	Lead-free Finish	
		Ordering Part Number ¹	Part Marking
16	NuDFN-16	CM1622 -08DE	P22

Note 1: Parts are shipped in Tape & Reel form unless otherwise specified.

Specifications

ABSOLUTE MAXIMUM RATINGS		
PARAMETER	RATING	UNITS
Storage Temperature Range	-65 to +150	°C
DC Power per Resistor	100	mW
DC Package Power Rating	500	mW

STANDARD OPERATING CONDITIONS		
PARAMETER	RATING	UNITS
Operating Temperature Range	-40 to +85	°C

ELECTRICAL OPERATING CHARACTERISTICS (NOTE1)

SYMBOL	PARAMETER	CONDITIONS	MIN	TYP	MAX	UNITS
R	Resistance	$I_R = 20\text{mA}$	85	100	115	Ω
C_{TOTAL}	Total Channel Capacitance	At 2.5VDC Reverse Bias, 1MHz, 30mVAC	20	25	30	pF
C	Capacitance C	At 2.5VDC Reverse Bias, 1MHz, 30mVAC		12.5		pF
V_{DIODE}	Standoff Voltage	$I_{\text{DIODE}} = 10\mu\text{A}$		6.0		V
I_{LEAK}	Diode Leakage Current (reverse bias)	$V_{\text{DIODE}} = +3.3\text{V}$		0.01	0.2	μA
V_{SIG}	Signal Clamp Voltage	$I_{\text{LOAD}} = 1.0\text{mA}$	6.0	7.0	8.0	V
V_{ESD}	In-system ESD Withstand Voltage a) Human Body Model, MIL-STD-883, Method 3015 b) Contact Discharge per IEC 61000-4-2 Level 4	See Note 2	± 30 ± 15			kV kV
R_{DYN}	Dynamic Resistance Positive Negative			2.3 0.9		Ω Ω
f_c	Cut-off Frequency $Z_{\text{SOURCE}} = 50\Omega$, $Z_{\text{LOAD}} = 50\Omega$	Channel R = 100 Ω , Channel C = 25pF		115		MHz
$A_{1\text{GHz}}$	Absolute Attenuation @ 1GHz from 0dB Level	$Z_{\text{SOURCE}} = 50\Omega$, $Z_{\text{LOAD}} = 50\Omega$, DC Bias = 0V; See Notes 1 and 3.		-35		dB
$A_{800\text{MHz} - 6\text{GHz}}$	Absolute Attenuation @ 800MHz to 6GHz from 0dB Level	$Z_{\text{SOURCE}} = 50\Omega$, $Z_{\text{LOAD}} = 50\Omega$, DC Bias = 0V; See Notes 1 and 3.		30		dB

Note 1: $T_A = 25^\circ\text{C}$ unless otherwise specified.

Note 2: ESD applied to input and output pins with respect to GND, one at a time.

Note 3: Attenuation / RF curves characterized by a network analyzer using microprobes.

Performance Information

Typical Filter Performance ($T_A=25^\circ\text{C}$, DC Bias=0V, 50 Ohm Environment)

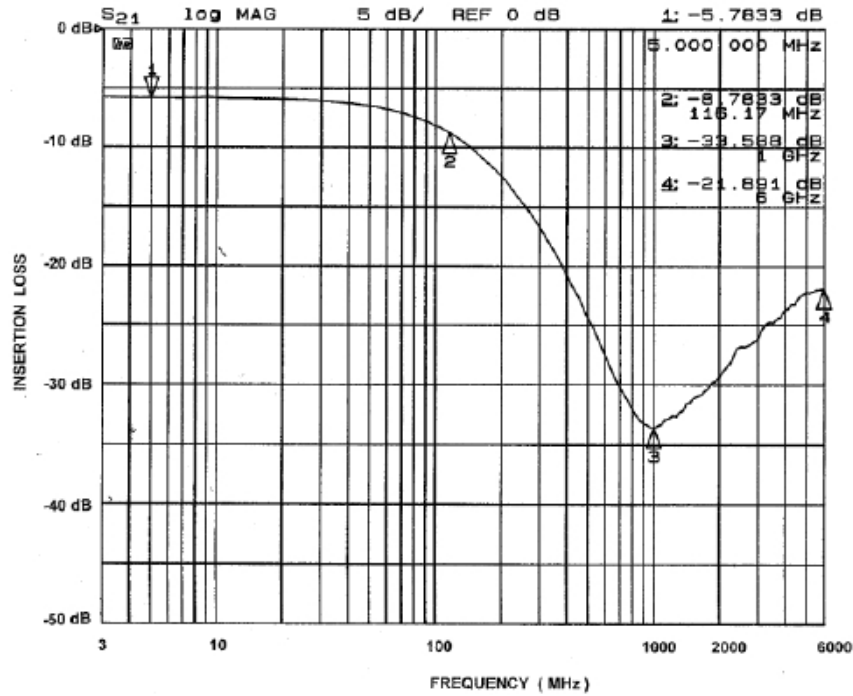

Figure 1. Insertion Loss vs. Frequency (FILTER1 Input to GND)

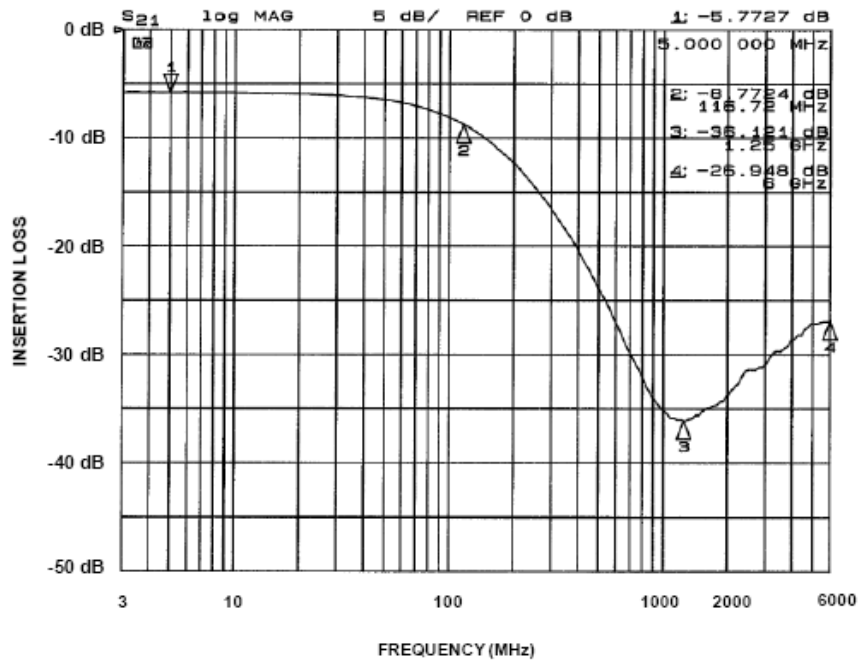

Figure 2. Insertion Loss vs. Frequency (FILTER2 Input to GND)

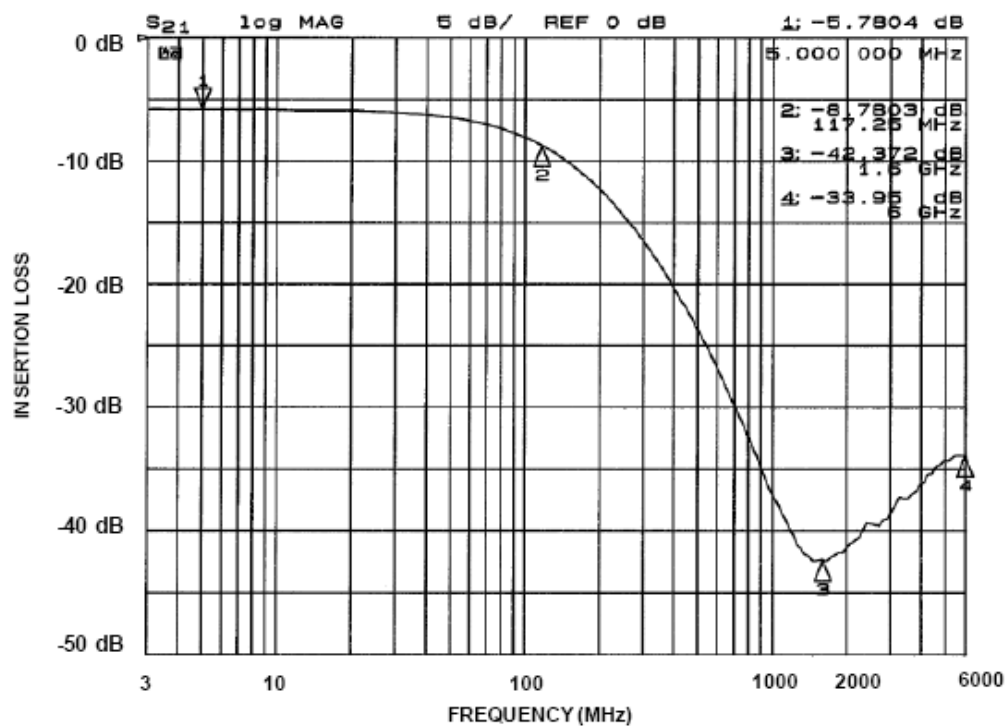

Figure 3. Insertion Loss vs. Frequency (FILTER3 Input to GND)

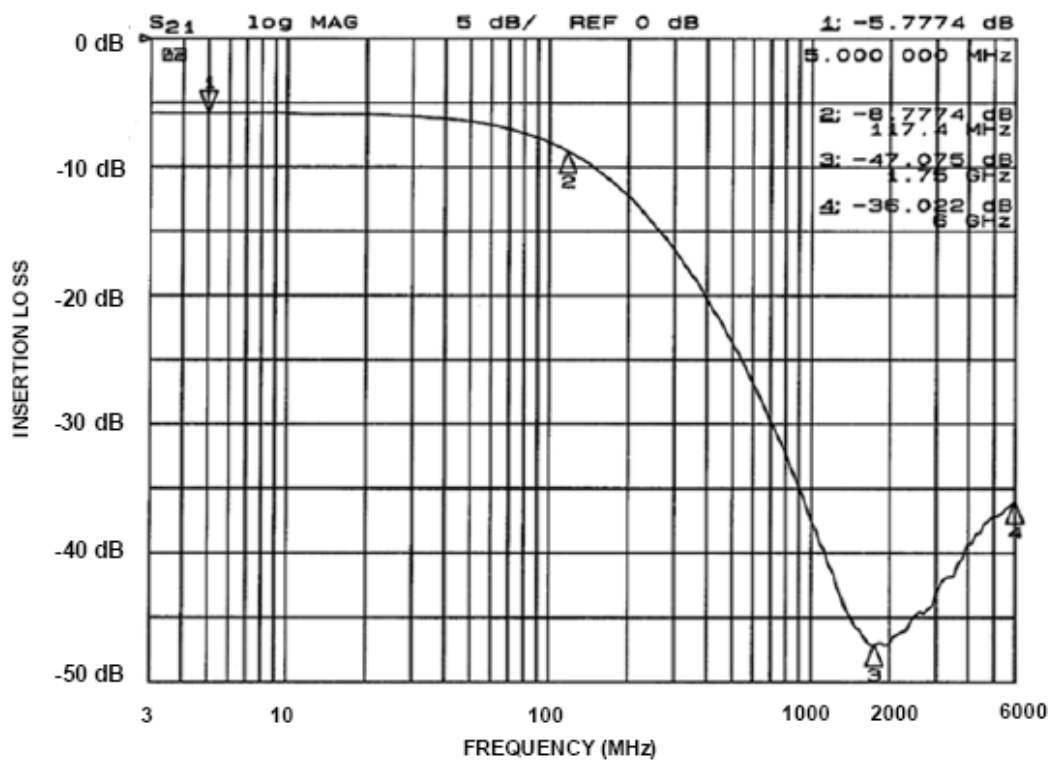

Figure 4. Insertion Loss vs. Frequency (FILTER4 Input to GND)

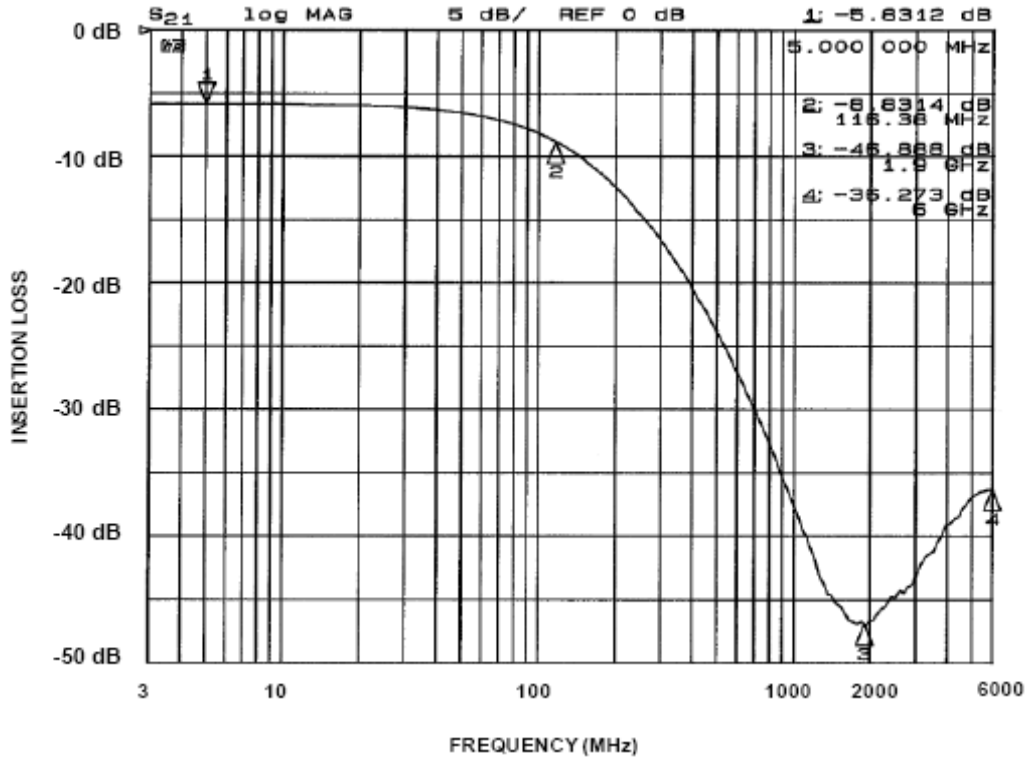

Figure 5. Insertion Loss vs. Frequency (FILTER5 Input to GND)

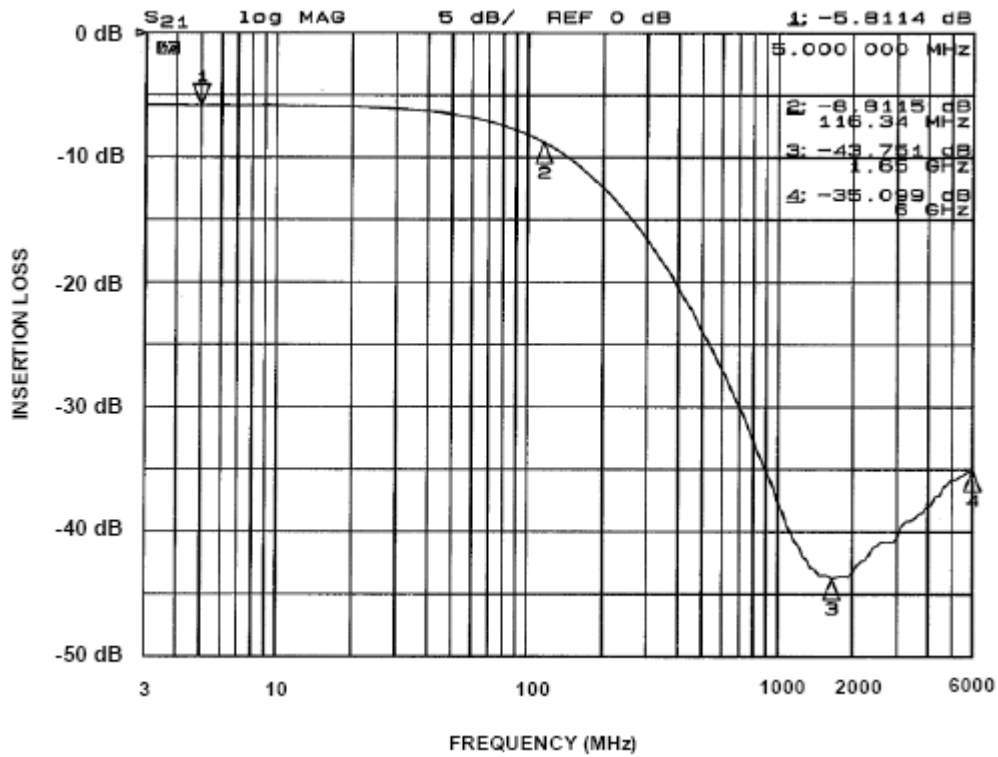

Figure 6. Insertion Loss vs. Frequency (FILTER6 Input to GND)

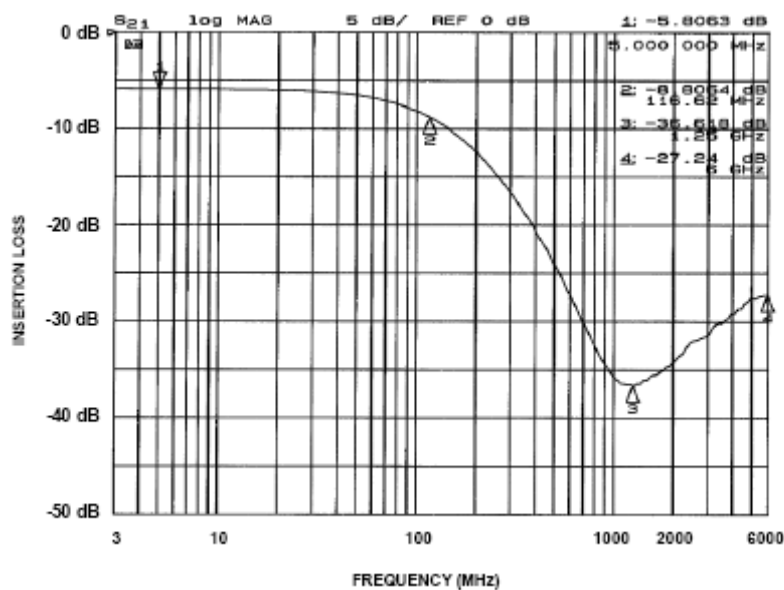

Figure 7. Insertion Loss vs. Frequency (FILTER7 Input to GND)

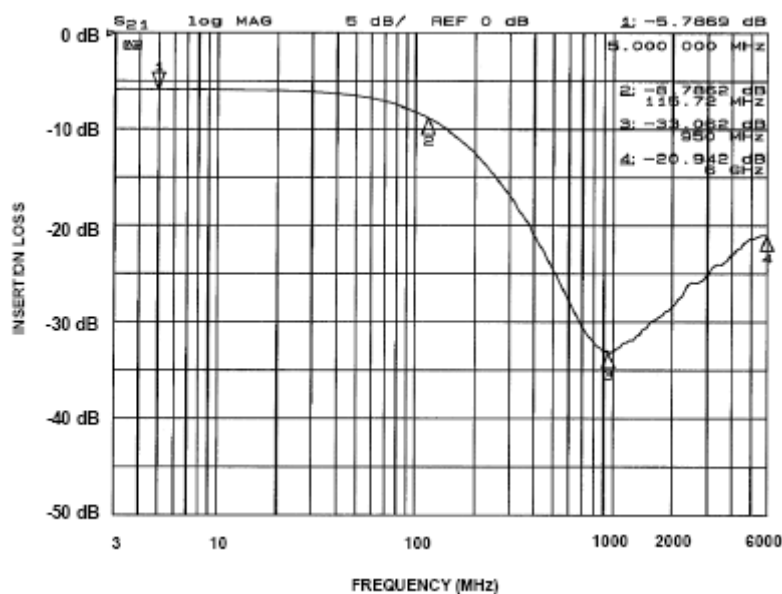

Figure 8. Insertion Loss vs. Frequency (FILTER8 Input to GND)

Typical Diode Capacitance vs. Input Voltage

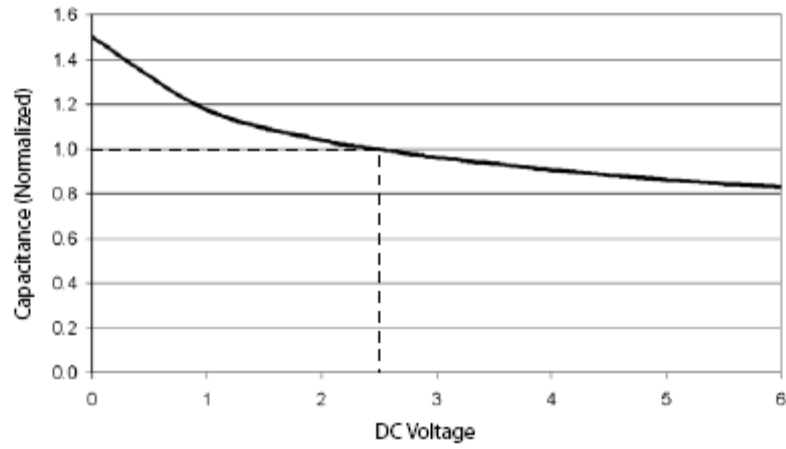

Figure 9. Filter Capacitance vs. Input Voltage (normalized to capacitance at 2.5VDC and 25°C)

Mechanical Details

NuDFN-16 Mechanical Specifications, 0.4mm

Dimensions for the CM1622 supplied in a 16-lead, 0.4mm pitch NuDFN package are presented below.

PACKAGE DIMENSIONS						
Package	NuDFN					
JEDEC No.	MO-229C*					
Leads	16					
Dim.	Millimeters			Inches		
	Min	Nom	Max	Min	Nom	Max
A	0.45	0.50	0.55	0.018	0.020	0.022
A1	0.00	0.02	0.05	0.000	0.001	0.002
A3	0.127 REF			0.005 REF		
b	0.15	0.20	0.25	0.006	0.008	0.010
b1	.20 BSC			0.008 BSC		
D	3.40	3.50	3.60	0.134	0.138	0.142
D2	2.70	2.80	2.90	0.106	0.110	0.114
E	1.10	1.20	1.30	0.043	0.047	0.051
E2	0.20	0.30	0.40	0.008	0.012	0.016
e	0.400 BSC			0.016 BSC		
F	0.20 REF			0.008 REF		
F1	0.30 REF			0.012 REF		
K	0.20 REF			0.008 REF		
L	0.20	0.25	0.30	0.008	0.010	0.012
L2	0.15 REF			0.006 REF		
# per tape and reel	3000 pieces					
Controlling dimension: millimeters						

*This package is compliant with JEDEC standard MO-229C with the exception of the D, D2, E, E2, and L dimensions as called out in the table above.

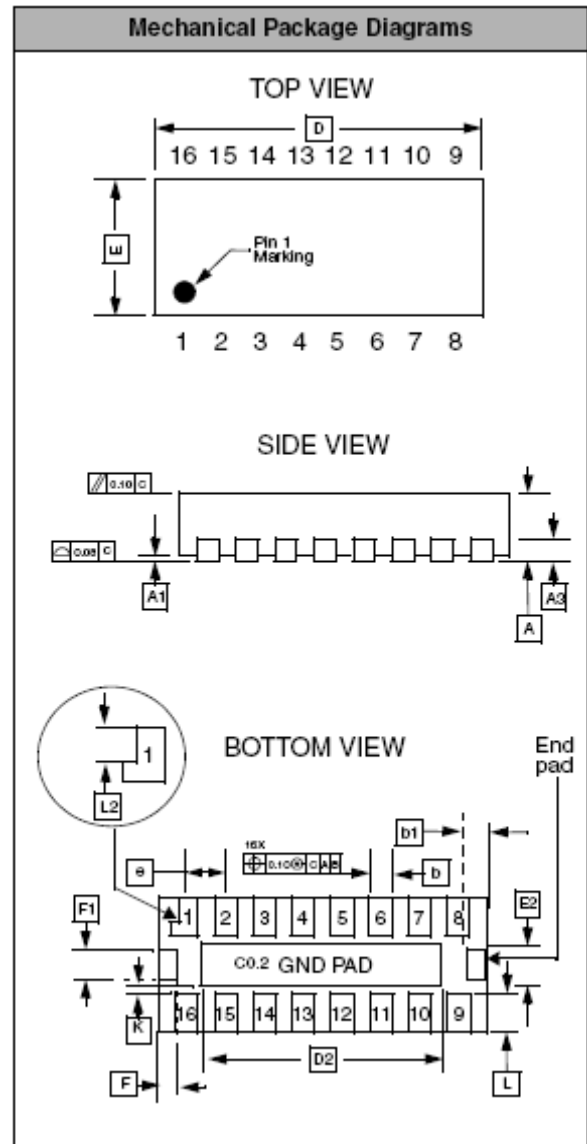

Tape and Reel Specifications

PART NUMBER	PACKAGE SIZE (mm)	POCKET SIZE (mm) $B_o \times A_o \times K_o$	TAPE WIDTH W	REEL DIAMETER	QTY PER REEL	P_o	P_1
CM1622	3.50 X 1.20 X 0.50	3.75 X 1.45 X 0.70	12mm	178mm (7")	3000	4mm	4mm

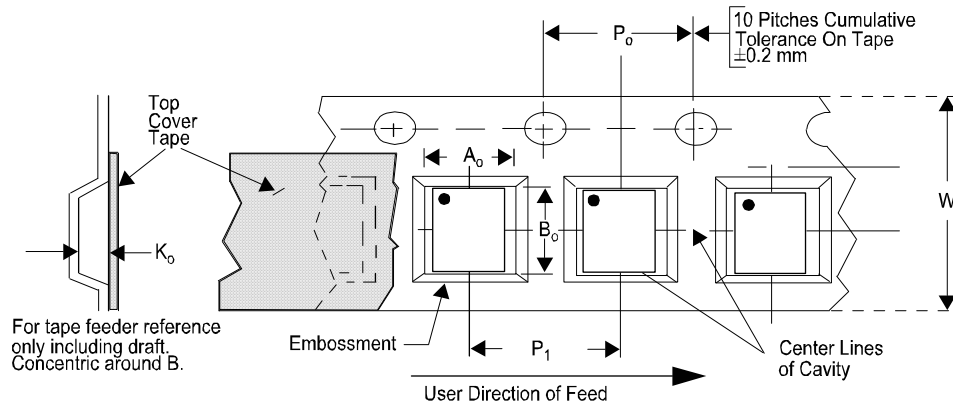

ON Semiconductor and  are registered trademarks of Semiconductor Components Industries, LLC (SCILLC). SCILLC reserves the right to make changes without further notice to any products herein. SCILLC makes no warranty, representation or guarantee regarding the suitability of its products for any particular purpose, nor does SCILLC assume any liability arising out of the application or use of any product or circuit, and specifically disclaims any and all liability, including without limitation special, consequential or incidental damages. "Typical" parameters which may be provided in SCILLC data sheets and/or specifications can and do vary in different applications and actual performance may vary over time. All operating parameters, including "Typicals" must be validated for each customer application by customer's technical experts. SCILLC does not convey any license under its patent rights nor the rights of others. SCILLC products are not designed, intended, or authorized for use as components in systems intended for surgical implant into the body, or other applications intended to support or sustain life, or for any other application in which the failure of the SCILLC product could create a situation where personal injury or death may occur. Should Buyer purchase or use SCILLC products for any such unintended or unauthorized application, Buyer shall indemnify and hold SCILLC and its officers, employees, subsidiaries, affiliates, and distributors harmless against all claims, costs, damages, and expenses, and reasonable attorney fees arising out of, directly or indirectly, any claim of personal injury or death associated with such unintended or unauthorized use, even if such claim alleges that SCILLC was negligent regarding the design or manufacture of the part. SCILLC is an Equal Opportunity/Affirmative Action Employer. This literature is subject to all applicable copyright laws and is not for resale in any manner.

PUBLICATION ORDERING INFORMATION

LITERATURE FULFILLMENT:

Literature Distribution Center for ON Semiconductor
P.O. Box 5163, Denver, Colorado 80217 USA
Phone: 303-675-2175 or 800-344-3860 Toll Free USA/Canada
Fax: 303-675-2176 or 800-344-3867 Toll Free USA/Canada
Email: orderlit@onsemi.com

N. American Technical Support: 800-282-9855
Toll Free USA/Canada
Europe, Middle East and Africa Technical Support:
Phone: 421 33 790 2910
Japan Customer Focus Center
Phone: 81-3-5773-3850

ON Semiconductor Website: www.onsemi.com

Order Literature: <http://www.onsemi.com/orderlit>

For additional information, please contact your local
Sales Representative