

# MITSUBISHI IGBT MODULES

## CM400HA-24H

HIGH POWER SWITCHING USE  
INSULATED TYPE

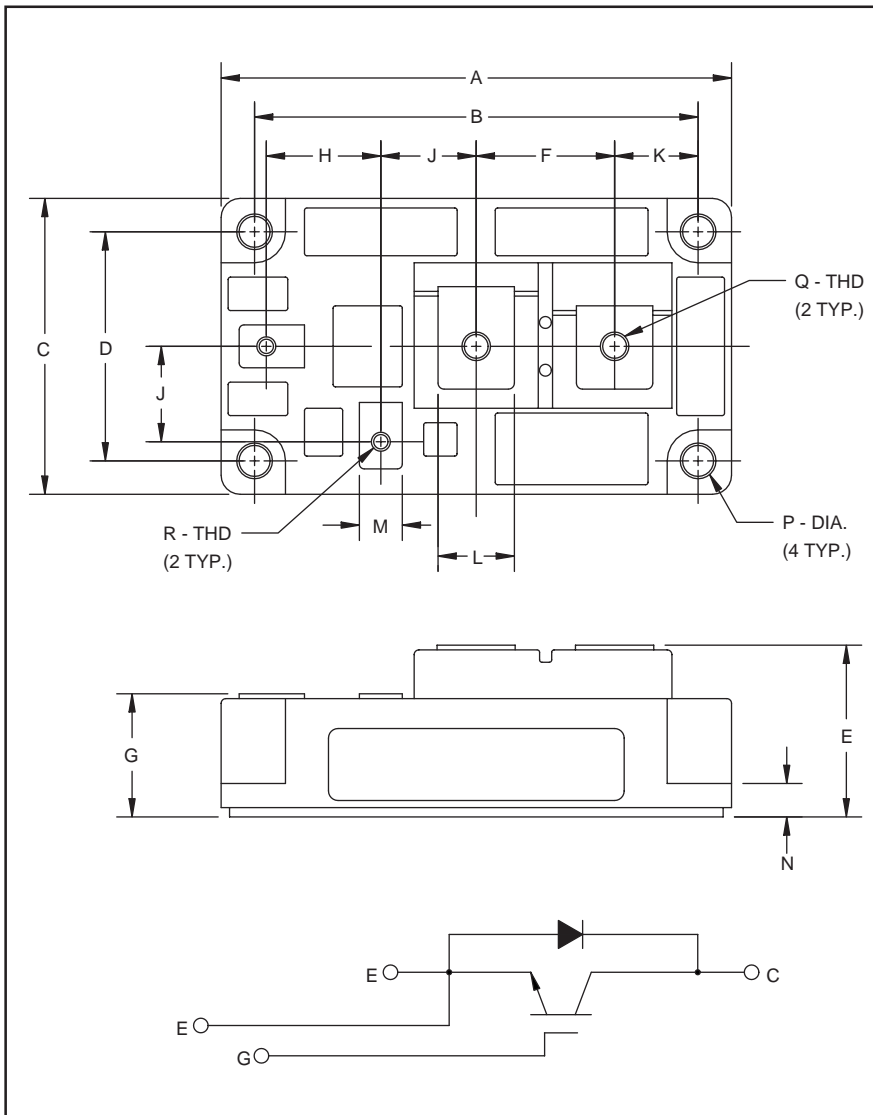

### Description:

Mitsubishi IGBT Modules are designed for use in switching applications. Each module consists of one IGBT in a single configuration with a reverse-connected super-fast recovery free-wheel diode. All components and interconnects are isolated from the heat sinking baseplate, offering simplified system assembly and thermal management.

### Features:

- Low Drive Power
- Low  $V_{CE(sat)}$
- Discrete Super-Fast Recovery Free-Wheel Diode
- High Frequency Operation
- Isolated Baseplate for Easy Heat Sinking

### Applications:

- AC Motor Control
- Motion/Servo Control
- UPS
- Welding Power Supplies

### Ordering Information:

Example: Select the complete part module number you desire from the table below -i.e. CM400HA-24H is a 1200V ( $V_{CES}$ ), 400 Ampere Single IGBT Module.

Type	Current Rating Amperes	$V_{CES}$ Volts (x 50)
CM	400	24

### Outline Drawing and Circuit Diagram

Dimensions	Inches	Millimeters
A	4.21	107.0
B	3.661±0.01	93.0±0.25
C	2.44	62.0
D	1.89±0.01	48.0±0.25
E	1.42+0.04/-0.02	36.0+1.0/-0.5
F	1.14	29.0
G	1.02+0.04/-0.2	25.8+1.0/-0.5
H	0.94	24.0

Dimensions	Inches	Millimeters
J	0.79	20.0
K	0.69	17.5
L	0.63	16.0
M	0.35	9.0
N	0.28	7.0
P	0.26 Dia.	Dia. 6.5
Q	M6 Metric	M6
R	M4 Metric	M4

## CM400HA-24H

HIGH POWER SWITCHING USE  
INSULATED TYPEAbsolute Maximum Ratings,  $T_j = 25\text{ }^\circ\text{C}$  unless otherwise specified

	Symbol	Ratings	Units
Junction Temperature	$T_j$	-40 to 150	$^\circ\text{C}$
Storage Temperature	$T_{stg}$	-40 to 125	$^\circ\text{C}$
Collector-Emitter Voltage (G-E SHORT)	$V_{CES}$	1200	Volts
Gate-Emitter Voltage (C-E SHORT)	$V_{GES}$	$\pm 20$	Volts
Collector Current ( $T_c = 25\text{ }^\circ\text{C}$ )	$I_C$	400	Amperes
Peak Collector Current ( $T_j \leq 150\text{ }^\circ\text{C}$ )	$I_{CM}$	800*	Amperes
Emitter Current** ( $T_c = 25\text{ }^\circ\text{C}$ )	$I_E$	400	Amperes
Peak Emitter Current**	$I_{EM}$	800*	Amperes
Maximum Collector Dissipation ( $T_c = 25\text{ }^\circ\text{C}$ )	$P_c$	2800	Watts
Mounting Torque, M6 Main Terminal	–	1.96~2.94	N · m
Mounting Torque, M6 Mounting	–	1.96~2.94	N · m
Mounting Torque, M4 Terminal	–	0.98~1.47	N · m
Weight	–	400	Grams
Isolation Voltage (Main Terminal to Baseplate, AC 1 min.)	$V_{iso}$	2500	Vrms

\* Pulse width and repetition rate should be such that the device junction temperature ( $T_j$ ) does not exceed  $T_{j(max)}$  rating.\*\*Represents characteristics of the anti-parallel, emitter-to-collector free-wheel diode (FWDi).s not exceed  $T_{j(max)}$  rating.Static Electrical Characteristics,  $T_j = 25\text{ }^\circ\text{C}$  unless otherwise specified

Characteristics	Symbol	Test Conditions	Min.	Typ.	Max.	Units
Collector-Cutoff Current	$I_{CES}$	$V_{CE} = V_{CES}, V_{GE} = 0V$	–	–	2.0	mA
Gate Leakage Current	$I_{GES}$	$V_{GE} = V_{GES}, V_{CE} = 0V$	–	–	0.5	$\mu\text{A}$
Gate-Emitter Threshold Voltage	$V_{GE(th)}$	$I_C = 40\text{mA}, V_{CE} = 10V$	4.5	6.0	7.5	Volts
Collector-Emitter Saturation Voltage	$V_{CE(sat)}$	$I_C = 400\text{A}, V_{GE} = 15V$	–	2.5	3.4**	Volts
		$I_C = 400\text{A}, V_{GE} = 15V, T_j = 150\text{ }^\circ\text{C}$	–	2.25	–	Volts
Total Gate Charge	$Q_G$	$V_{CC} = 600V, I_C = 400\text{A}, V_{GE} = 15V$	–	2000	–	nC
Emitter-Collector Voltage	$V_{EC}$	$I_E = 400\text{A}, V_{GE} = 0V$	–	–	3.4	Volts

\*\* Pulse width and repetition rate should be such that device junction temperature rise is negligible.

Dynamic Electrical Characteristics,  $T_j = 25\text{ }^\circ\text{C}$  unless otherwise specified

Characteristics	Symbol	Test Conditions	Min.	Typ.	Max.	Units
Input Capacitance	$C_{ies}$		–	–	80	nF
Output Capacitance	$C_{oes}$	$V_{GE} = 0V, V_{CE} = 10V$	–	–	28	nF
Reverse Transfer Capacitance	$C_{res}$		–	–	16	nF
Resistive	Turn-on Delay Time	$V_{CC} = 600V, I_C = 400\text{A}$	–	–	300	ns
	Rise Time					
Load	Rise Time	$V_{CC} = 600V, I_C = 400\text{A}$	–	–	500	ns
	Turn-off Delay Time					
Switching	Turn-off Delay Time	$V_{GE1} = V_{GE2} = 15V, R_G = 0.78\Omega$	–	–	350	ns
	Fall Time					
Diode Reverse Recovery Time	$t_{rr}$	$I_E = 400\text{A}, di_E/dt = -800\text{A}/\mu\text{s}$	–	–	250	ns
Diode Reverse Recovery Charge	$Q_{rr}$	$I_E = 400\text{A}, di_E/dt = -800\text{A}/\mu\text{s}$	–	2.97	–	$\mu\text{C}$

Thermal and Mechanical Characteristics,  $T_j = 25\text{ }^\circ\text{C}$  unless otherwise specified

Characteristics	Symbol	Test Conditions	Min.	Typ.	Max.	Units
Thermal Resistance, Junction to Case	$R_{th(j-c)}$	Per IGBT	–	–	0.045	$^\circ\text{C}/\text{W}$
Thermal Resistance, Junction to Case	$R_{th(j-c)}$	Per FWDi	–	–	0.09	$^\circ\text{C}/\text{W}$
Contact Thermal Resistance	$R_{th(c-f)}$	Per Module, Thermal Grease Applied	–	–	0.040	$^\circ\text{C}/\text{W}$

# CM400HA-24H

HIGH POWER SWITCHING USE  
INSULATED TYPE

**OUTPUT CHARACTERISTICS (TYPICAL)**

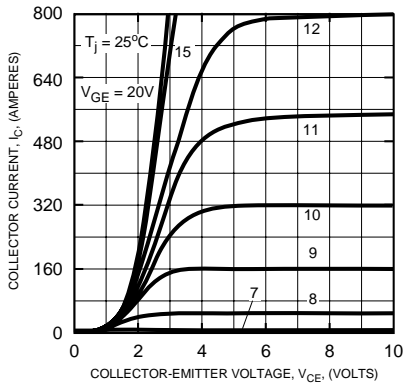

**TRANSFER CHARACTERISTICS (TYPICAL)**

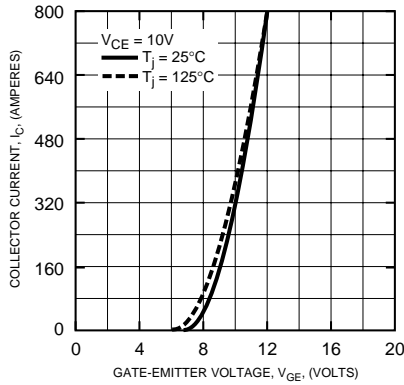

**COLLECTOR-EMITTER SATURATION VOLTAGE CHARACTERISTICS (TYPICAL)**

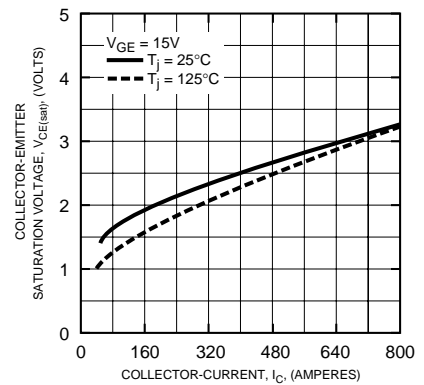

**COLLECTOR-EMITTER SATURATION VOLTAGE CHARACTERISTICS (TYPICAL)**

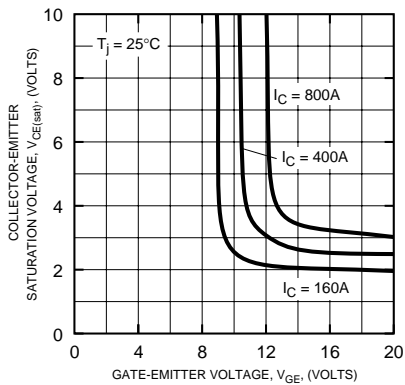

**FREE-WHEEL DIODE FORWARD CHARACTERISTICS (TYPICAL)**

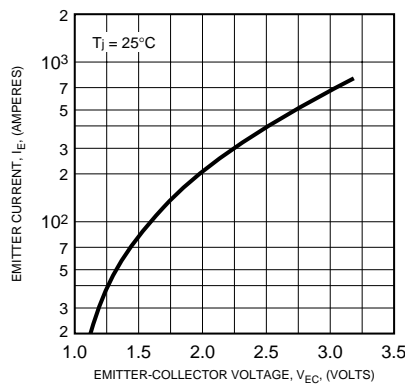

**CAPACITANCE VS.  $V_{CE}$  (TYPICAL)**

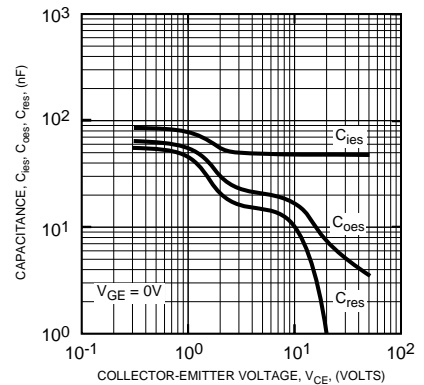

**HALF-BRIDGE SWITCHING CHARACTERISTICS (TYPICAL)**

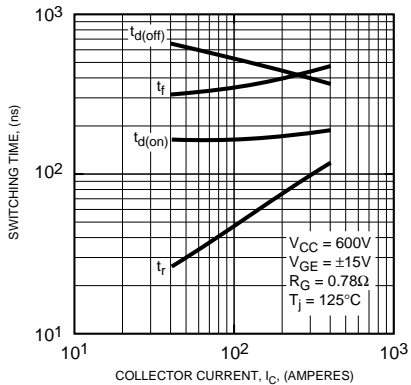

**REVERSE RECOVERY CHARACTERISTICS (TYPICAL)**

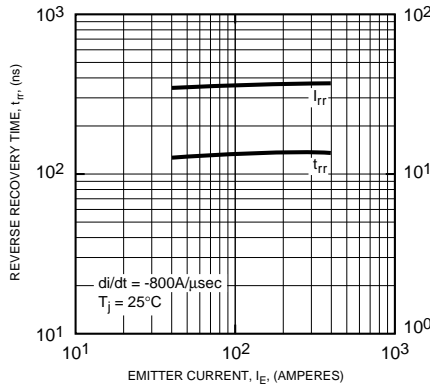

**GATE CHARGE,  $V_{GE}$**

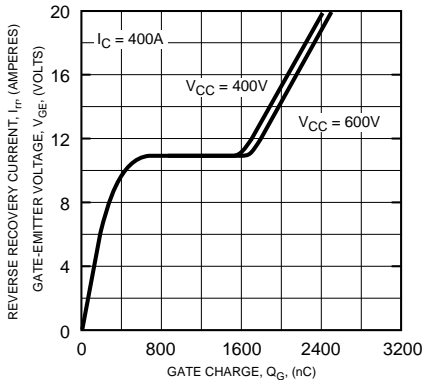

# CM400HA-24H

HIGH POWER SWITCHING USE  
INSULATED TYPE

